

**HIKVISION**



**TurboHD**  
**DS-2CE12D8T-PIRL**  
**Bullet Camera**  
User Manual

Thank you for purchasing our product. If there are any questions, or requests, do not hesitate to contact the dealer.

This manual may contain several technical incorrect places or printing errors, and the content is subject to change without notice. The updates will be added to new versions of this manual. We will readily improve or update the products or procedures described in the manual.

## Regulatory Information

### FCC Information

Please take attention that changes or modification not expressly approved by the party responsible for compliance could void the user's authority to operate the equipment.

**FCC Compliance:** This equipment has been tested and found to comply with the limits for a Class A digital device, pursuant to part 15 of the FCC Rules. These limits are designed to provide reasonable protection against harmful interference when the equipment is operated in a commercial environment. This equipment generates, uses, and can radiate radio frequency energy and, if not installed and used in accordance with the instruction manual, may cause harmful interference to radio communications. Operation of this equipment in a residential area is likely to cause harmful interference in which case the user will be required to correct the interference at his own expense.

### FCC Conditions

This device complies with part 15 of the FCC Rules. Operation is subject to the following two conditions:

1. This device may not cause harmful interference.
2. This device must accept any interference received, including interference that may cause undesired operation.

### EU Conformity Statement

 This product and, if applicable, the supplied accessories too are marked with "CE" and comply therefore with the applicable harmonized European standards listed under the Low Voltage Directive 2014/35/EU, the EMC Directive 2014/30/EU, the RoHS Directive 2011/65/EU.

 **2012/19/EU (WEEE Directive):** Products marked with this symbol cannot be disposed of as unsorted municipal waste in the European Union. For proper recycling, return this product to your local supplier upon the purchase of equivalent new equipment, or dispose of it at designated collection points. For more information see: [www.recyclethis.info](http://www.recyclethis.info).

 **2006/66/EC (Battery Directive):** This product contains a battery that cannot be disposed of as unsorted municipal waste in the European Union. See the product documentation for specific battery information. The battery is marked with this symbol, which may include lettering to indicate cadmium (Cd), lead (Pb), or mercury (Hg). For proper recycling, return the battery to your supplier or to a designated collection point. For more information see: [www.recyclethis.info](http://www.recyclethis.info).

### Industry Canada ICES-003 Compliance

This device meets the CAN ICES-3 (A)/NMB-3(A) standards requirements.

### Warning

This is a class A product. In a domestic environment this product may cause radio interference in which case the user may be required to take adequate measures.



### Safety Instruction

These instructions are intended to ensure that user can use the product correctly to avoid danger or property loss.

The precaution measure is divided into "Warnings" and "Cautions".

**Warnings:** Serious injury or death may occur if any of the warnings are neglected.

**Cautions:** Injury or equipment damage may occur if any of the cautions are neglected.

	
<b>Warnings</b> Follow these safeguards to prevent serious injury or death.	<b>Cautions</b> Follow these precautions to prevent potential injury or material damage.



## Warnings

- In the use of the device, you must be in strict compliance with the electrical safety regulations of the nation and region.
- Input voltage should meet both the SELV (Safety Extra Low Voltage) and the Limited Power Source with 12 VDC according to the IEC60950-1 standard. Refer to technical specifications for detailed information.
- Do not connect multiple devices to one power adapter to avoid overheating or a fire hazard caused by overload.
- Make sure that the plug is firmly connected to the power socket.
- Make sure that the device is firmly fixed if wall mounting or ceiling mounting is adopted.
- If smoke, odor, or noise rise from the device, turn off the power at once and unplug the power cord, and then contact the service center.
- Never attempt to disassemble the camera by unprofessional personal.



## Cautions

- Do not drop the camera or subject it to physical shock.
- Do not touch sensor modules with fingers.
- Do not place the camera in extremely hot, cold (the operating temperature shall be  $-40^{\circ}$  to  $60^{\circ}$  C), dusty, or damp locations, and do not expose it to high electromagnetic radiation.
- If cleaning is necessary, use a clean cloth with a bit of ethanol and wipe it gently.
- Do not aim the camera at the sun or extra bright places.
- The sensor may be burned out by a laser beam, so when any laser equipment is in use, make sure that the surface of the sensor will not be exposed to the laser beam.
- Do not expose the device to high electromagnetic radiation or extremely hot, cold, dusty, or damp environment.
- To avoid heat accumulation, good ventilation is required for the operating environment.
- Keep the camera away from liquid while in use for non-waterproof device.
- While in delivery, the camera shall be packed in its original packing or packing of the same texture.

## Mark Description

Table 0-1 Mark Description

Mark	Description
---	DC Voltage

# 1 Introduction

---

## 1.1 Product Features

The camera is applicable for both indoor and outdoor conditions, and the application scenarios including roads, warehouses, underground parking lots, bars, etc.

The main features are as follows:

- High performance CMOS sensor

- Low illumination, 0.005 lux @ (f/2.0, AGC on), 0 lux with IR
- IR cut filter with auto switch
- OSD menu with configurable parameters
- Auto white balance
- Internal synchronization
- SMART IR mode
- Visible alarm
- PIR detection
- 3-axis adjustment

## 1.2 Overview

### 1.2.1 Overview of Camera

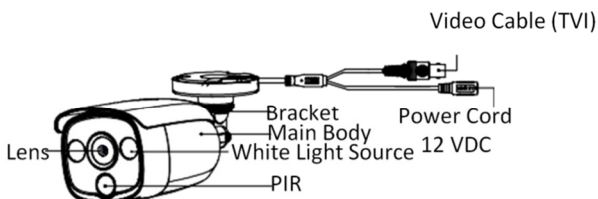

Figure 1-2 Overview of Camera

## 2 Installation

### Before you start

- Make sure that the device in the package is in good condition and all the assembly parts are included.
- Make sure that all the related equipment is powered off during the installation.
- Check the specification of the products for the installation environment.
- Check whether the power supply matches your power output to avoid damage.
- Make sure the wall is strong enough to withstand three times the weight of the camera and the mount.
- If the wall is cement, insert expansion bolts before installing the camera. If the wall is wood, use self-tapping screws to secure the camera.
- If the product does not function properly, contact your dealer or the nearest service center. Do NOT disassemble the camera for repair or maintenance yourself.

### 2.1 Installation of Camera

#### 2.1.1 Ceiling/Wall Mounting without Junction Box

##### Steps:

1. Paste the drill template (supplied) to the spot you want to install the camera.
2. Drill the screw holes according to the drill template, and the cable hole (optional) on the ceiling.

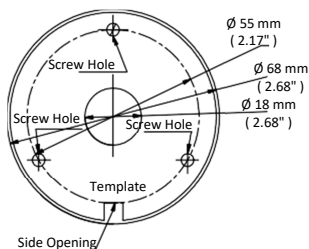

Figure 2-8 Drill Template

**Note:**

Drill the cable hole in the center of the drill template when using ceiling outlet to route the cable.

3. Route the cables through the cable hole (optional) or the side opening.

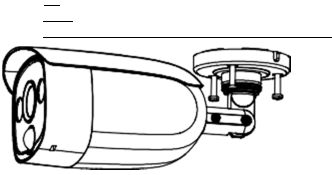

Figure 2-9 Fix the Camera to the Ceiling

4. Fix the camera to the ceiling with supplied screws.

**Note:**

- The supplied screw package contains self-tapping screws and expansion bolts.
  - For cement wall/ceiling, expansion bolts are required to fix the camera. For wood wall/ceiling, self-tapping screws are required.
5. Connect the corresponding power cord and video cable.
  6. Power on the camera to check whether the image on the monitor is at an optimum angle. If not, adjust the surveillance angle.

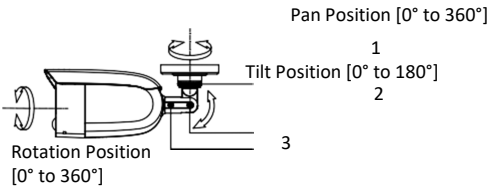

Figure 2-10 3-Axis Adjustment

- 1) Loosen the No. 1 adjusting screw to adjust the pan position [0° to 360°]. Tighten the No. 1 adjusting screw.
- 2) Loosen the No. 2 adjusting screw to adjust the tilting position [0° to 180°]. Tighten the No. 2 adjusting screw.
- 3) Loosen the No. 3 adjusting screw to adjust the rotation position [0° to 360°]. Tighten the No. 3 adjusting screw.

**2.1.2 Ceiling/Wall Mounting with Junction Box**

**Before you start:**

You must purchase a junction box separately.

**Steps:**

1. Paste the drill template on the ceiling/wall.
2. Drill screw holes and the cable hole (optional) in the ceiling/wall according to the holes of the drill template.

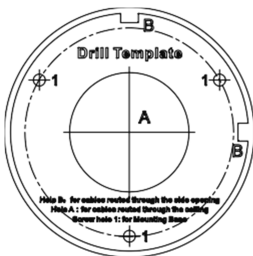

Figure 2-11 Drill Template

**Note:**

Drill the cable hole, when adopting ceiling outlet to route the cable.

3. Take apart the junction box, and align the screw holes of the bullet camera with those on the Junction box cover.
4. Fix the camera on the junction box cover with three supplied screws.

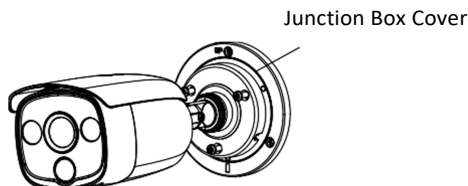

Figure 2-12 Install the Junction Box

5. Secure the junction box body with supplied screws on the ceiling/wall.
6. Route the cables through the bottom cable hole or the side cable hole of the junction box.
7. Combine the junction box cover with its body with supplied screws on the junction box's cover.

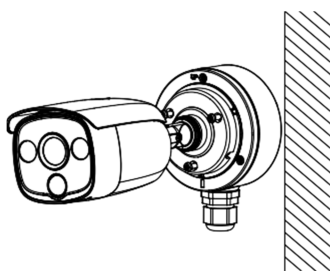



Figure 2-13 Combine the Junction Box Cover with its Body

8. Repeat the step 5 and 6 of 2.2.1 *Ceiling/Wall Mounting without Junction Box* to complete the installation.

### 3 Menu Description

**Purpose:**

Call the menu by clicking the  button on the PTZ Control interface, or call the preset No. 95.

**Steps:**

1. Connect the camera to the TVI DVR and the monitor, shown as the figure 3-1.

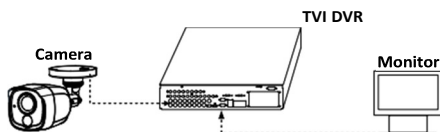



Figure 3-1 Connection

2. Power on the analog camera, TVI DVR, and the monitor to view the image on the monitor.
3. Click PTZ Control to enter the PTZ Control interface. Call the camera menu by clicking  button, or call the preset No. 95.

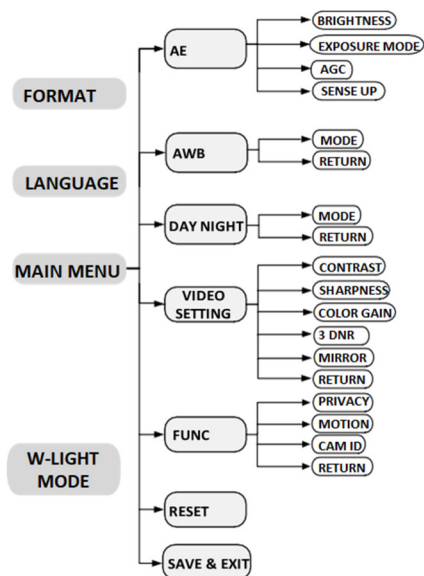

Figure 3-2 Main Menu Overview

4. Click the direction arrow to control the camera. 1). Click up/down direction button to select the item.

1). Click Iris + to confirm the selection.

2). Click left/right direction button to adjust the value of the selected item.

### 3.1 FORMAT

#### PAL (Phase Alternating Lines)

PAL is a color encoding system for analog television used in broadcast television systems in most countries.

#### NTSC: (National Television System Committee)

NTSC is the analog television system that is used in most of North America, parts of South America, Myanmar, South Korea, etc.

### 3.2 LANGUAGE

Supports English and Chinese.

### 3.3 WHITE LIGHT

The embedded white light source can be worked as the visible alarm or the lighting.

In the **WHITE MODE**, you can set the mode as **ALARM**, **LIGHTING** or **OFF**.

#### 3.3.1 ALARM

In **ALARM** mode, you can set the **TRIGGER MODE** to **DVR** or **CAMERA**.

#### DVR

Set the **TRIGGER MODE** to **DVR**. In this way, the alarm signal is sent from the DVR and the camera works as the alarm detector in the process. Besides, the alarm type only supported by the DVR can also trigger the visible alarm in the camera.

#### CAMERA

Set the **TRIGGER MODE** to **CAMERA**, the embedded PIR module sends the alarm signal to the visible alarm in the camera when the PIR module detected the alarm source.

#### 3.3.2 LIGHTING

Select the **LIGHTING** mode, the embedded white light source turns on in poor light conditions.

#### Note:

- Under **LIGHTING** mode, the image is in color at all times, and there's no

**DAY NIGHT** setting in the menu.

### 3.3.3 OFF

Set **OFF** to turn off this function.

## 3.4 MAIN MENU

### 3.4.1 AE (AUTO EXPOSURE)

Auto Exposure describes the brightness-related parameters, which can be adjusted by **BRIGHTNESS**, **EXPOSURE MODE**, **AGC**, and **SENSE UP**.

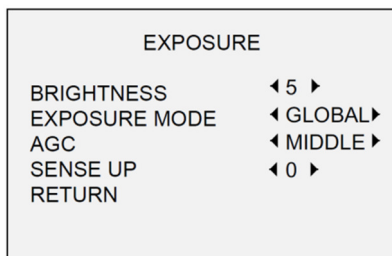

Figure 3-3 AE

- **BRIGHTNESS**

Brightness refers to the brightness of the image.

You can set the brightness value from 1 to 10 to darken or brighten the image. The higher the value, the brighter the image.

- **EXPOSURE MODE**

You can set the **EXPOSURE MODE** to **GLOBAL**, **BLC**, and **WDR**.

- **GLOBAL**

GLOBAL refers to the normal exposure mode, which adjusts lighting distribution, variations, and non-standard processing.

- **BLC (Backlight Compensation)**

BLC (Backlight Compensation) compensates light to the object in the front to make it clear, but this may cause the over-exposure of the background where the light is strong.

When BLC is selected as the exposure mode, the BLC level can be adjusted from 0 to 8.

- **WDR (Wide Dynamic Range)**

The wide dynamic range helps the camera provide clear images even under backlight circumstances. WDR balances the brightness level of the whole image and provides clear images with details.

- **AGC (Auto Gain Control)**

It optimizes the clarity of the image in poor light conditions. The **GAIN** level can be set as **HIGH**, **MIDDLE**, or **LOW**. Select **OFF** to disable the **GAIN** function.

**Note:**

The noise will be amplified when the GAIN is on.

- **SENSE UP**

Sense up increases the exposure on a single frame, which makes a camera more sensitive to the light so it can produce images even in low lux conditions.

You can set the SENS-UP function as x0, x2, x4, x6, x8, x10, x12, x14, or x16 according to the different light conditions.

### 3.4.2 AWB (Auto White Balance)

White balance, the white rendition function of the camera, is to adjust the color temperature according to the environment. It can remove unrealistic color casts in the image. You can set WB mode as **ATW** or **MWB**.

- **ATW (Auto Tracking White Balance)**

Under **ATW** mode, white balance is adjusted automatically according to the color temperature of the scene illumination.





- **MWB (Manual White Balance)**

You can set the **R GAIN/B GAIN** value from 1 to 255 to adjust the shades of red/blue color of the image.

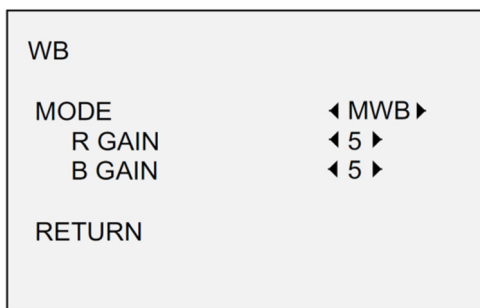

Figure 3-4 MWB MODE

### 3.4.3 DAY NIGHT

**COLOR**, **BW** (Black White), and **AUTO** are selectable for DAY and NIGHT switches.

**Note:**

Under **LIGHTING** mode, the image is in color all the time and there's no **DAY NIGHT** settings in the menu.

- **COLOR**

The image is in color in day mode all the time.

- **B/W**

The image is black and white all the time, and the infrared turns on in poor light conditions.

- **AUTO**

You can turn on/off the **INFRARED**, and set the value of **SMART IR** in this menu.

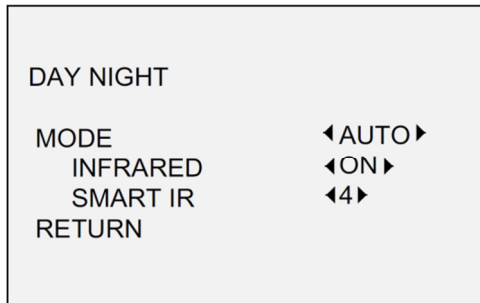

Figure 3-5 DAY NIGHT

- **INFRARED**

You can turn on/off the infrared to meet the requirements of different circumstances.

- **SMART IR**

The **Smart IR** function is used to adjust the light to its most suitable intensity and prevent the image from overexposure. The **SMART IR** value can be adjusted from 1 to 8. The higher the value, the more obvious the effect.

### 3.4.4 VIDEO SETTING

Move the cursor to **VIDEO SETTING** and click **Iris+** to enter the submenu.

**CONTRAST**, **SHARPNESS**, **COLOR GAIN**, **3 DNR**, and **MIRROR** are adjustable.

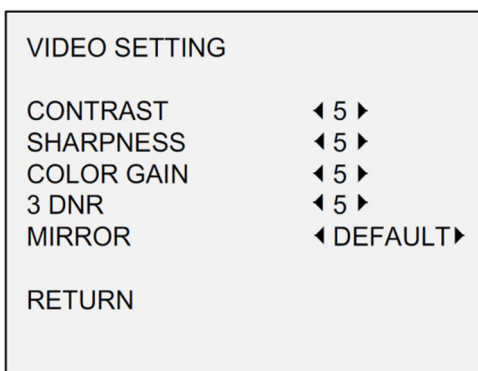

Figure 3-6 VIDEO SETTING

- **CONTRAST**

This feature enhances the difference in color and light between parts of an image. You can set the **CONTRAST** value from 1 to 10.

- **SHARPNESS**

Sharpness determines the amount of detail the imaging system can reproduce. You can set the **SHARPNESS** value from 1 to 10.

- **COLOR GAIN**

Adjust this feature to change the saturation of the color. The value ranges from 1 to 10.

- **3 DNR (Digital Noise Reduction)**

The 3 DNR function can decrease the noise effect, especially when capturing moving images in poor light conditions, and deliver more accurate and sharper images. You can set the **3 DNR** value from 1 to 10.

- **MIRROR**

**DEFAULT, H, V, and HV** are selectable for mirror.

**DEFAULT:** The mirror function is disabled.

**H:** The image flips 180° horizontally.

**V:** The image flips 180° vertically.

**HV:** The image flips 180° both horizontally and vertically.

### 3.4.5 FUNC (Functions)

In the FUNC sub-menu, you can set the privacy mask, the motion detection, and camera ID.

- **PRIVACY**

The privacy mask allows you to cover certain areas that you don't want to be viewed or recorded. Up to four privacy areas are configurable.

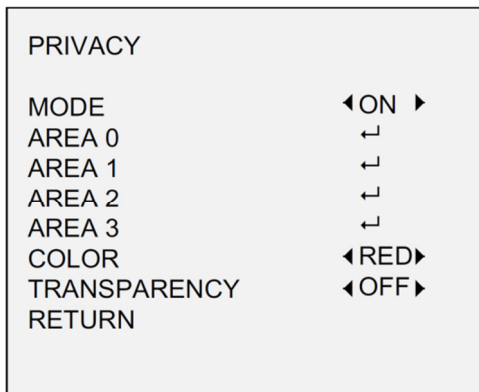

Figure 3-7 PRIVACY

Select a **PRIVACY** area. Set **DISPLAY** status to **ON**. Click **Up/Down/Left/Down** button to define the position and the size of the area.



- **MOTION**

In the user-defined motion detection surveillance area, the moving object can be detected and the alarm will be triggered. Up to four motion detection areas can be configured.

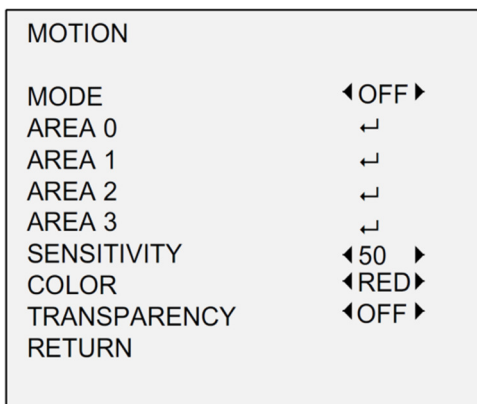

Figure 3-8 MOTION

Select a MOTION area. Set **DISPLAY** status to **ON**. Click **Up/Down/Left/Right** button to define the position and size of the area. Set the SENSITIVITY from 0 to 100.

- **CAMERA ID**

Edit the camera ID on this section.

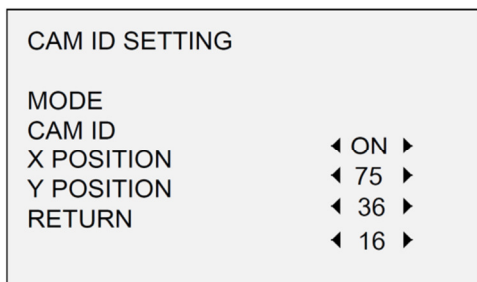

Figure 3-9 CAM ID SETTING

Set the **MODE** to **ON**. Click **Up/Down/Left/Right** button to choose the camera ID and the position.

### 3.4.6 RESET

Reset all the settings to the factory defaults.

### 3.4.7 SAVE & EXIT

Move the cursor to **SAVE & EXIT** and click **Iris+** to save the setting and exit the menu.