



**DS-90xxHUHI-F8/N**  
**Digital Video Recorder**  
**User Manual**

041717NA

**COPYRIGHT © 2017 Hangzhou Hikvision Digital Technology Co., Ltd. ALL RIGHTS RESERVED.**

Any and all information, including, among others, wordings, pictures, graphs are the properties of Hangzhou Hikvision Digital Technology Co., Ltd. or its subsidiaries (hereinafter referred to be "Hikvision"). This user manual (hereinafter referred to be "the Manual") cannot be reproduced, changed, translated, or distributed, partially or wholly, by any means, without the prior written permission of Hikvision. Unless otherwise stipulated, Hikvision does not make any warranties, guarantees or representations, express or implied, regarding to the Manual.

**About this Manual**

This Manual is applicable to TurboHD Digital Video Recorder (DVR).

The screen shots in this manual are for illustrative purposes only; your screen(s) may differ.

The Manual includes instructions for using and managing the product. Pictures, charts, images and all other information hereinafter are for description and explanation only. The information contained in the Manual is subject to change, without notice, due to firmware updates or other reasons. Please find the latest version in the company website (<http://overseas.hikvision.com/en/>).

Please use this user manual under the guidance of professionals.

**Trademarks Acknowledgement**

**HIKVISION** and other Hikvision's trademarks and logos are the properties of Hikvision in various jurisdictions. Other trademarks and logos mentioned below are the properties of their respective owners.

**Legal Disclaimer**

TO THE MAXIMUM EXTENT PERMITTED BY APPLICABLE LAW, THE PRODUCT DESCRIBED, WITH ITS HARDWARE, SOFTWARE AND FIRMWARE, IS PROVIDED "AS IS", WITH ALL FAULTS AND ERRORS, AND HIKVISION MAKES NO WARRANTIES, EXPRESS OR IMPLIED, INCLUDING WITHOUT LIMITATION, MERCHANTABILITY, SATISFACTORY QUALITY, FITNESS FOR A PARTICULAR PURPOSE, AND NON-INFRINGEMENT OF THIRD PARTY. IN NO EVENT WILL HIKVISION, ITS DIRECTORS, OFFICERS, EMPLOYEES, OR AGENTS BE LIABLE TO YOU FOR ANY SPECIAL, CONSEQUENTIAL, INCIDENTAL, OR INDIRECT DAMAGES, INCLUDING, AMONG OTHERS, DAMAGES FOR LOSS OF BUSINESS PROFITS, BUSINESS INTERRUPTION, OR LOSS OF DATA OR DOCUMENTATION, IN CONNECTION WITH THE USE OF THIS PRODUCT, EVEN IF HIKVISION HAS BEEN ADVISED OF THE POSSIBILITY OF SUCH DAMAGES.

REGARDING TO THE PRODUCT WITH INTERNET ACCESS, THE USE OF PRODUCT SHALL BE WHOLLY AT YOUR OWN RISKS. HIKVISION SHALL NOT TAKE ANY RESPONSIBILITIES FOR ABNORMAL OPERATION, PRIVACY LEAKAGE OR OTHER DAMAGES RESULTING FROM CYBER ATTACK, HACKER ATTACK, VIRUS INSPECTION, OR OTHER INTERNET SECURITY RISKS; HOWEVER, HIKVISION WILL PROVIDE TIMELY TECHNICAL SUPPORTS IF REQUIRED.

SURVEILLANCE LAWS VARY BY JURISDICTION. PLEASE CHECK ALL RELEVANT LAWS IN YOUR JURISDICTION BEFORE USING THIS PRODUCT IN ORDER TO ENSURE THAT YOUR USE CONFORMS THE APPLICABLE LAW. HIKVISION SHALL NOT BE LIABLE IN THE EVENT THAT THIS PRODUCT IS USED WITH ILLEGITIMATE PURPOSES.

IN THE EVENT OF ANY CONFLICTS BETWEEN THIS MANUAL AND THE APPLICABLE LAW, THE LATER PREVAILS.

**Regulatory Information**

**FCC Information**

Please take attention that changes or modification not expressly approved by the party responsible for compliance could void the user's authority to operate the equipment.

**FCC Compliance**

This equipment has been tested and found to comply with the limits for a Class A digital device, pursuant to part 15 of the FCC Rules. These limits are designed to provide reasonable protection against harmful interference when the equipment is operated in a commercial environment. This equipment generates, uses, and can radiate radio frequency energy and, if not installed and used in accordance with the instruction manual, may cause harmful interference to radio communications. Operation of this equipment in a residential area is likely to cause harmful interference in which case the user will be required to correct the interference at his own expense.

**FCC Conditions**

This device complies with part 15 of the FCC Rules. Operation is subject to the following two conditions:

1. This device may not cause harmful interference.
2. This device must accept any interference received, including interference that may cause undesired operation.

**EU Conformity Statement**



This product and - if applicable - the supplied accessories too are marked with "CE" and comply therefore with the applicable harmonized European standards listed under the EMC Directive 2014/30/EU, the LVD Directive 2014/35/EU, the RoHS Directive 2011/65/EU.



2012/19/EU (WEEE directive): Products marked with this symbol cannot be disposed of as unsorted municipal waste in the European Union. For proper recycling, return this product to your local supplier upon the purchase of equivalent new equipment, or dispose of it at designated collection points. For more information see: [www.recyclethis.info](http://www.recyclethis.info)





2006/66/EC (battery directive): This product contains a battery that cannot be disposed of as unsorted municipal waste in the European Union. See the product documentation for specific battery information. The battery is marked with this symbol, which may include lettering to indicate cadmium (Cd), lead (Pb), or mercury (Hg). For proper recycling, return battery to your supplier or a designated collection point. For more information see [www.recyclethis.info](http://www.recyclethis.info)

**Industry Canada ICES-003 Compliance**

This device meets the CAN ICES-3 (A)/NMB-3(A) standards requirements.

## Symbol Conventions

The symbols that may be found in this document are defined as follows.

Symbol	Description
 <b>NOTE</b>	Provides additional information to emphasize or supplement important points of the main text.
 <b>WARNING</b>	Indicates a potentially hazardous situation, which if not avoided, could result in equipment damage, data loss, performance degradation, or unexpected results.
 <b>DANGER</b>	Indicates a hazard with a high level of risk, which if not avoided, will result in death or serious injury.

## Safety Instructions

- Proper configuration of all passwords and other security settings is the responsibility of the installer and/or end-user.
- In the use of the product, you must be in strict compliance with the electrical safety regulations of the nation and region. Please refer to technical specifications for detailed information.
- Input voltage should meet both the SELV (Safety Extra Low Voltage) and the Limited Power Source with 100 to 240 VAC or 12 VDC according to the IEC60950-1 standard. Please refer to technical specifications for detailed information.
- Do not connect several devices to one power adapter as adapter overload may cause over-heating or a fire hazard.
- Please make sure that the plug is firmly connected to the power socket.
- If smoke, odor or noise rise from the device, turn off the power at once and unplug the power cable, and then please contact the service center.

## Preventive and Cautionary Guidelines

Before connecting and operating your device, please be advised of the following:

- Ensure unit is installed in a well-ventilated, dust-free environment.
- Unit is designed for indoor use only.
- Keep all liquids away from the device.
- Ensure environmental conditions meet factory specifications.
- Ensure unit is properly secured to a rack or shelf. Major shocks or jolts to the unit as a result of dropping it may cause damage to the sensitive electronics within the unit.
- Use the device in conjunction with an UPS if possible.
- Power down the unit before connecting and disconnecting accessories and peripherals.
- A factory recommended HDD should be used for this device.
- Improper use or replacement of the battery may result in hazard of explosion. Replace with the same or equivalent type only. Dispose of used batteries according to the instructions provided by the battery manufacturer.

---

# Product Key Features

## General

- Connectable to HD-TVI and analog cameras
- Supports Hikvision-C protocol for Up-the-Coax control of camera OSD and Hikvision PTZ cameras
- Each channel supports dual-streams. Sub-stream supports up to WD1 resolution
- The HUHI series main stream supports up to 3 MP resolution on all channels. IP cameras up to 8MP can be added. Analog channels can be disabled one by one to allow for additional IP cameras
- If the 3 MP camera is connected to the channel that supports up to 1080p signal input, it will switch to 1080p signal input. When the 3 MP signal is switched to 1080p signal, the PAL will be switched to 1080p/25 Hz, and the NTSC will be switched to 1080p/30 Hz
- Independent configuration for each channel, including resolution, frame rate, bit rate, image quality, etc.
- Encoding for both video stream and video & audio stream; audio and video synchronization during composite stream encoding
- One-key enable or disable H.264+
- Supports configuring night to day sensitivity, day to night sensitivity and IR light brightness for the connected analog cameras supporting these parameters
- Watermark technology

## Local Monitoring

- 1/4/6/8/9/16 screen live view is supported, and the display sequence of screens is adjustable
- Live view screen can be switched in group and manual switch and automatic cycle live view are also provided, the interval of automatic cycle can be adjusted
- CVBS output only serves as the aux output or live view output
- Quick setting menu is provided for live view
- The selected live view channel can be shielded
- Motion detection, video-tampering detection, video exception alarm, video loss alarm, and VCA alarm functions
- Privacy mask
- Support for over 60 PTZ protocols, including Pelco D, Pelco C, etc.; PTZ preset, patrol and pattern
- Zooming in/out by clicking the mouse and PTZ tracing by dragging mouse

## HDD Management

- Each disk with a maximum of 6 TB storage
- 8 network disks (8 NAS disks, 8 IP SAN disks, or n NAS disks + m IP SAN disks ( $n + m \leq 8$ )) can be connected
- Remaining recording time of the HDD can be viewed
- Supports cloud storage
- S.M.A.R.T. and bad sector detection
- HDD sleeping function
- HDD property: redundancy, read-only, read/write (R/W)
- HDD group management
- HDD quota management; different capacity can be assigned to different channels.

## Recording and Playback

- Holiday recording schedule configuration
- Cycle and non-cycle recording modes
- Normal and event video encoding parameters
- Multiple recording types: manual, continuous, alarm, motion, motion | alarm, motion & alarm, and Event
- 8 recording time periods with separated recording types
- Main stream and sub-stream configurable for simultaneous recording
- Pre-record and post-record for motion detection triggered recording, and pre-record time for schedule and manual recording
- Searching record files and captured pictures by events (alarm input/motion detection)
- Customization of tags, searching and playing back by tags
- Locking and unlocking of record files
- Local redundant recording and capture when configured with compatible NAS devices
- When HD-TVI input is connected, the resolution will be overlaid on the bottom right corner of the live view for five seconds. When CVBS input is connected, the information such as NTSC or PAL will be overlaid on the bottom right corner of the live view for 5 seconds.
- Searching and playing back record files by camera number, recording type, start time, end time, etc.
- Smart playback allows for faster searching
- Main stream and sub-stream selectable for local/remote playback
- Digital zooming during playback
- Multi-channel reverse playback
- Supports pause, fast forward, slow forward, skip forward, and skip backward when playing back, selecting playback time by dragging the mouse on the progress bar
- 4/8/16-ch synchronous playback
- Manual capture, continuous capture of video images and playback of captured pictures



---

## **Backup**

- Export data to a USB device (4/8/16 channel) and eSATA device (16 channel only)
- Export video clips from playback
- Management and maintenance of back-up devices

## **Alarms and Exceptions**

- Configurable arming time of alarm input/output
- Alarm for video loss, motion detection, video tampering, abnormal signal, video input/recording resolution mismatch, illegal login, network disconnected, IP confliction, record/capture exception, HDD error, HDD full, etc.
- Alarm triggers full screen monitoring, audio alarm, notifying surveillance center, sending e-mail, and alarm output
- Supports coaxial alarm
- Automatic reboot when system watchdog detects problems in attempt to restore full function

## **Other Local Functions**

- Manual and automatic video quality diagnostics
- Operable by mouse and remote control
- Three-level user management; admin user can create multiple operating accounts and define their operating permission, which includes the permission to access any channel
- Completeness of operation, alarm, exceptions and log writing and searching
- Manually triggering and clearing alarms
- Importing and exporting of configuration file of devices
- Getting camera type information automatically
- Unlock pattern allows admin quick access to menu
- Password can be shown in clear text by clicking icon
- GUID file (password key) can be exported for easy password reset

## **Network Functions**

- One self-adaptive 10M/100M/1000M network interface (16 channel) or 1 self-adaptive 10M/100Mbps network interface (4/8 channel)
- IPv6 is supported
- TCP/IP protocol, PPPoE, DHCP, DNS, NTP, SADP, SMTP, NFS, iSCSI, UPnP™, and HTTPS are supported
- Supports access by Hik Cloud P2P
- TCP, UDP, and RTP for unicast
- Auto/Manual port mapping by UPnP™
- Remote search, playback, download, locking and unlocking the record files, and downloading files broken transfer auto resume
- Remote parameters setup; remote import/export of device parameters
- Remote viewing of the device status, system logs and alarm status
- Remote keyboard operation
- Remote HDD formatting and firmware upgrade
- Remote system restart
- Supports upgrading via remote FTP server
- RS-485 transparent channel transmission
- Alarm and exception information can be sent to the remote host
- Remotely start/stop recording
- Remotely start/stop alarm output
- Remote PTZ control
- Remote JPEG capture
- Two-way audio and voice broadcasting
- Output bandwidth limit configurable
- Embedded WEB server
- If DHCP is enabled, you can enable or disable DNS DHCP and edit the Preferred DNS Server and Alternate DNS Server

## **Development Scalability**

- SDK for Windows and Linux system
- Source code of application software for demo
- Development supports and training for application system

---

# Table of Contents

<b>1. Legend</b> .....	<b>9</b>
1.1. Front Panel.....	9
1.2. Rear Panel .....	9
1.3. Menu Tree.....	11
<b>2. IR Remote Control Operations</b> .....	<b>12</b>
2.1. Troubleshooting the Remote Control.....	12
<b>3. USB Mouse Operation</b> .....	<b>13</b>
3.1. Attach Mouse .....	13
3.2. Mouse Operation.....	13
<b>4. Soft Keyboard</b> .....	<b>14</b>
<b>5. Getting Started</b> .....	<b>14</b>
5.1. Starting Up and Shutting Down the DVR.....	14
5.1.1. Before Starting.....	14
5.1.2. Starting the DVR.....	14
5.1.3. Shutting Down the DVR.....	14
5.1.4. Rebooting the DVR.....	15
5.2. Activating the Device.....	15
<b>6. Using the Unlock Pattern for Login</b> .....	<b>18</b>
6.1. Configuring the Unlock Pattern.....	18
6.2. Logging in via Unlock Pattern.....	19
<b>7. Login and Logout</b> .....	<b>20</b>
7.1. User Login.....	20
7.2. User Logout.....	23
<b>8. Adding Cameras</b> .....	<b>23</b>
8.1. Analog Cameras.....	23
8.1.1. Adding Analog Cameras .....	23
8.1.2. Disabling Analog Cameras To Increase Number of IP Cameras .....	23
8.2. IP Cameras .....	24
8.2.1. Adding IP Cameras.....	24
8.2.2. Custom Adding IP Camera .....	26
8.2.3. Modify IP Camera Settings .....	26
8.2.4. Upgrade Camera Firmware.....	27
8.2.5. Advanced Settings.....	27
8.3. Activating Camera .....	29
<b>9. Live View</b> .....	<b>34</b>
9.1. Live View Settings.....	34
9.1.1. General.....	34

9.1.2.	View.....	35
9.1.3.	Channel-Zero Encoding.....	35
9.1.4.	Live View Icons.....	36
9.2.	Operations in Live View Mode.....	36
9.3.	Using the Mouse in Live View .....	37
9.4.	Quick Setting Toolbar in Live View Mode.....	38
9.5.	Adjusting Live View Settings .....	39
9.6.	Manual Video Quality Diagnostics.....	41
<b>10.</b>	<b>PTZ Controls.....</b>	<b>42</b>
10.1.	Configuring PTZ Settings .....	42
10.2.	Setting PTZ Presets, Patrols, and Patterns.....	43
10.2.1.	Before Starting.....	43
10.2.2.	Customizing Presets.....	43
10.2.3.	Calling Presets .....	44
10.2.4.	Customizing Patrols.....	45
10.2.5.	Calling Patrols .....	46
10.2.6.	Customizing Patterns.....	47
10.2.7.	Calling Patterns .....	47
10.2.8.	Customizing Linear Scan Limit .....	48
10.2.9.	Calling Linear Scan.....	49
10.2.10.	One-Touch Park .....	49
10.2.11.	PTZ Control Panel.....	50
<b>11.</b>	<b>Recording Settings .....</b>	<b>52</b>
11.1.	Configuring Encoding Parameters.....	52
11.1.1.	Before Starting.....	52
11.2.	Configuring Recording and Capture Schedule .....	57
11.2.1.	Set the Record Schedule.....	57
11.2.2.	Draw the Schedule .....	59
11.3.	Configuring Motion Detection Recording and Capture .....	60
11.4.	Configuring Alarm Triggered Recording .....	61
11.5.	Configuring Event Recording.....	63
11.6.	Configuring Manual Recording and Continous Capture .....	64
11.7.	Configuring Holiday Recording.....	64
11.8.	Configuring HDD Group .....	66
11.9.	Files Protection.....	67
11.9.1.	Protect File by Locking the Record Files .....	67
11.9.2.	Protect File by Setting HDD Property to Read-Only .....	68
<b>12.</b>	<b>One-Key H.264+ Enable/Disable .....</b>	<b>69</b>
12.1.	One-Key H.264+ Enabling for All Cameras .....	69
12.2.	One-Key H.264+ Disabling for All Cameras .....	69
<b>13.</b>	<b>Playback .....</b>	<b>70</b>
13.1.	Playing Back Record Files.....	70
13.1.1.	Instant Playback by Channel .....	70
13.1.2.	Play Back by Time.....	71
13.2.	Playback Interface.....	72
13.3.	Playing Back by Event Search .....	73
13.4.	Playing Back by Tag.....	75
13.4.1.	Before Playing Back by Tag .....	75
13.5.	Playing Back by System Logs .....	77

13.6. Playing Back by Sub-Periods .....	78
13.7. Playing Back External Files .....	79
13.8. Auxiliary Playback Functions.....	79
13.8.1. Playing Back Frame-by-Frame .....	79
13.8.2. Digital Zoom .....	79
13.8.3. Reverse Playback of Multi-Channels .....	80
<b>14. Backing Up Record Files .....</b>	<b>81</b>
14.1. Before Starting .....	81
14.2. Backing Up by Normal Video/Picture Search .....	81
14.2.1. Back Up Using USB Flash Drives and USB HDDs .....	81
14.3. Backing Up by Event Search.....	83
14.4. Backing Up Video Clips .....	84
14.5. Managing Backup Devices .....	84
<b>15. Alarm Settings.....</b>	<b>85</b>
15.1. Setting Motion Detection .....	85
15.2. Setting Sensor Alarms.....	87
15.3. Detecting Video Loss .....	89
15.4. Detecting Video Tampering.....	91
15.5. Setting All-Day Video Quality Diagnostics.....	92
15.6. Handling Exceptions.....	93
15.7. Setting Alarm Response Actions .....	95
<b>16. Network Settings.....</b>	<b>96</b>
16.1. Configuring General Settings .....	96
16.2. Configuring Advanced Settings .....	97
16.2.1. Configuring PPPoE Settings.....	97
16.2.2. Register a Hik-Connect P2P Cloud Service Account .....	98
16.2.3. Enable Hik-Connect P2P on the NVR.....	99
16.2.4. Add the NVR to the Hik-Connect Service .....	99
16.2.5. Accessing the NVR.....	100
16.2.6. Configuring NTP Server.....	100
16.2.7. Configuring NAT .....	101
16.2.8. Configuring More Settings .....	102
16.2.9. Configuring HTTPS Port.....	104
16.2.10. Configuring E-Mail .....	105
16.2.11. Checking Network Traffic.....	107
16.3. Configuring Network Detection.....	107
16.3.1. Testing Network Delay and Packet Loss .....	107
16.3.2. Exporting Network Packet .....	108
16.3.3. Checking Network Status .....	109
16.3.4. Checking Network Statistics .....	110
<b>17. HDD Management .....</b>	<b>111</b>
17.1. Initializing HDDs .....	111
17.2. Managing Network HDD .....	112
17.3. Managing HDD Groups .....	114
17.3.1. Setting HDD Groups.....	114
17.3.2. Setting HDD Property .....	116
17.4. Configuring Quota Mode .....	117
17.5. Configuring Cloud Storage .....	118
17.6. Checking HDD Status .....	120

17.6.1. Checking HDD Status in HDD Information Interface.....	120
17.6.2. Checking HDD Status in System Information Interface .....	120
17.7. Checking S.M.A.R.T. Information.....	121
17.8. Detecting Bad Sectors.....	121
17.9. Configuring HDD Error Alarms .....	122
<b>18. RAID Setup .....</b>	<b>124</b>
18.1. Configuring Array .....	124
18.1.1. Before You Start.....	124
18.1.2. Introduction.....	124
18.1.3. Enable RAID.....	125
18.1.4. One-Touch Configuration .....	125
18.1.5. Manually Creating Array .....	126
18.2. Rebuilding Array.....	128
18.2.1. Before You Start.....	128
18.2.2. Automatically Rebuilding Array .....	129
18.2.3. Manually Rebuilding Array.....	129
18.3. Deleting Array.....	130
18.4. Checking and Editing Firmware.....	130
<b>19. POS Configuration .....</b>	<b>132</b>
19.1. Configuring POS Settings.....	132
19.2. Configuring Overlay Channel .....	137
19.3. Configuring POS Alarm .....	137
<b>20. Camera Settings.....</b>	<b>140</b>
20.1. Configuring OSD Settings .....	140
20.2. Configuring Privacy Mask.....	141
20.3. Configuring Video Parameters .....	142
20.3.1. Configuring Image Settings .....	142
20.3.2. Configuring Camera Parameters Settings .....	144
<b>21. DVR Management and Maintenance.....</b>	<b>145</b>
21.1. Viewing System Information.....	145
21.2. Searching Log Files.....	145
21.3. Importing/Exporting Configuration Files.....	148
21.3.1. Purpose .....	148
21.4. Upgrading System.....	148
21.4.1. Upgrading by Local Backup Device.....	148
21.4.2. Upgrading by FTP.....	149
21.5. Restoring Default Settings.....	150
21.6. Configuring General Settings .....	151
21.7. Configuring DST Settings.....	152
21.8. Configuring More Settings.....	152
21.9. Managing User Accounts .....	154
21.9.1. Adding a User.....	154
21.9.2. Deleting a User.....	158
21.9.3. Editing a User .....	158
<b>22. Appendix.....</b>	<b>161</b>
22.1. Glossary .....	161
22.2. Troubleshooting.....	162

# 1. Legend

## 1.1. Front Panel

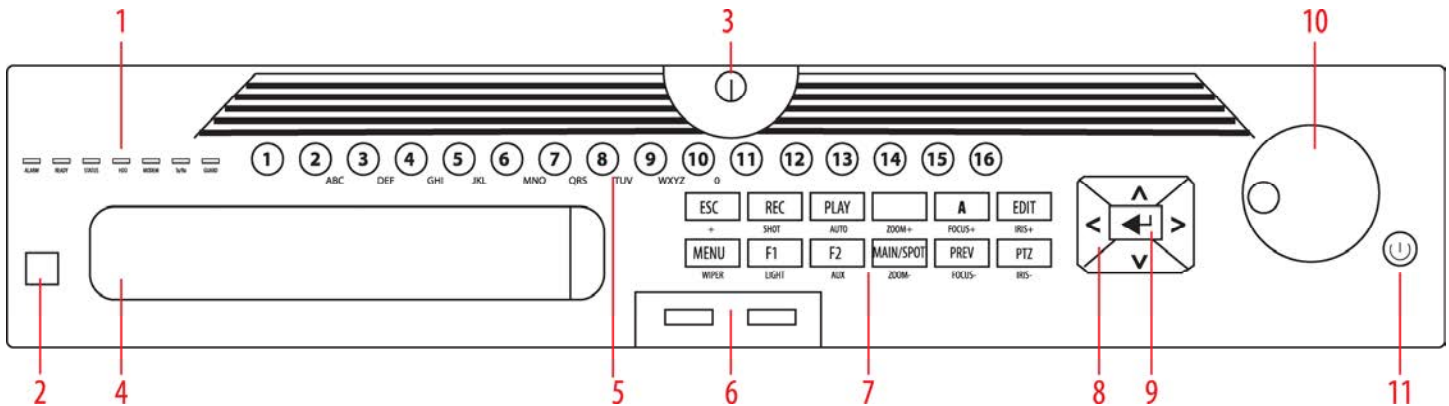

Figure 1, DS-90xxHUHI-F8/N Front Panel

No.	Item	Description
1.	Status Indicators	Ready   Flickers red when data is being read from or written to HDD
		HDD   Blinks red when data is being read from/written to HDD
		Tx/Rx   Blinks blue when network connection is functioning properly
2.	IR Sensor	For remote control
3.	Front Panel Lock	Locks access to hard drives
4.	DVD Bay	For DVD drive
5.	Number Buttons	To enter numbers
6.	USB Ports	Connects USB mouse or USB flash memory devices
7.	Function Buttons	Use to access device functions
8.	Direction Buttons	Move up/down/left/right
9.	Enter	Confirms menu selection. Ticks checkbox fields. In Playback mode, plays or pauses video. In Single Play mode, advances video a single frame.
10.	Scroll Wheel	Use to scroll through selections
11.	On/Off Power	Glows blue when device is on, red when powered off and in standby mode

## 1.2. Rear Panel

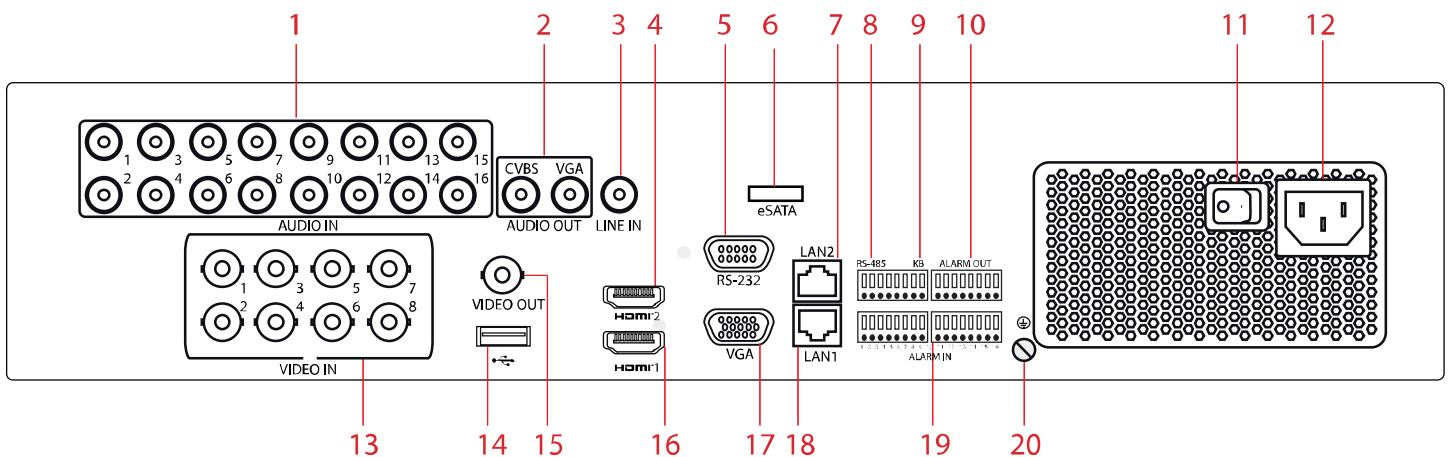

Figure 2, DS-9008HUHI-F8/N Rear Panel

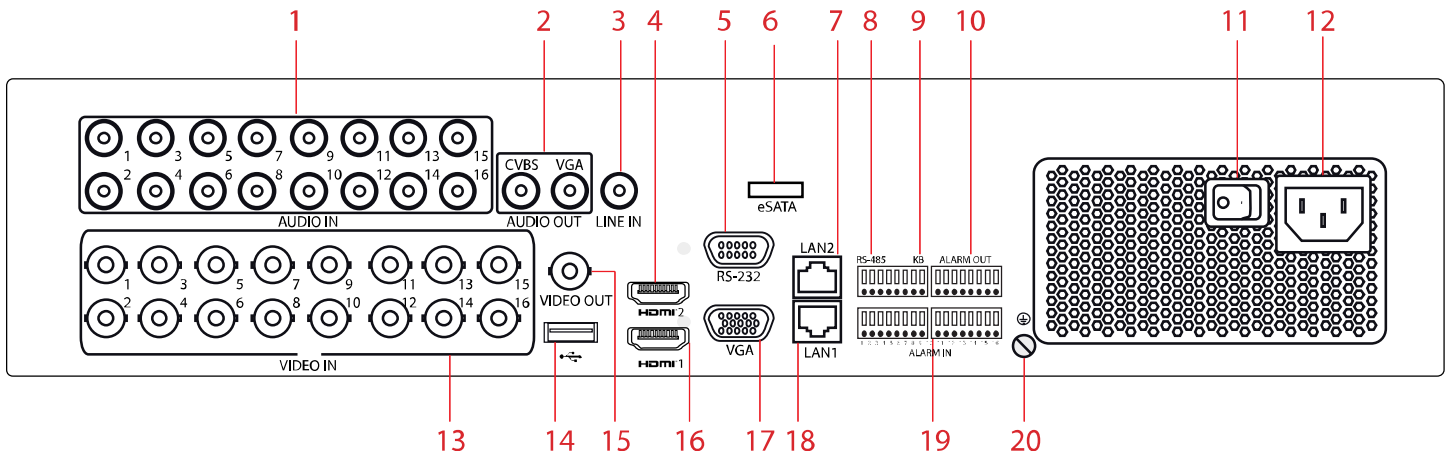

Figure 3, DS-9016HUHI-F8/N Rear Panel

No.	Item	Description
1	Audio In	RCA connectors for audio input
2	Audio Out	RCA connectors for audio output
3	Line In	Mic input for two-way communication
4	HDMI2	HDMI video output connector
5	RS-232 Interface	Connector for RS-232 devices
6	eSATA	Connector to external eSATA drive
7	LAN2	Connector for LAN (Local Area Network)
8	RS-485	Connector for RS-485 devices: T+ and T- pins connect to R+ and R- pins of PTZ receiver respectively D+, D- pin connects to Ta, Tb pin of controller (for cascading devices, the first DVR's D+, D- pin should be connected with the D+, D- pin of the next DVR)
9	KB	Connector for keyboard
10	Alarm Out	Connector for alarm outputs
11	Power Switch	Switch for turning device on/off
12	Power Input	100 to 240 VAC power
13	Video In	BNC connectors for video input
14	USB Interface	Connect to USB mouse or USB flash memory devices
15	Video Out	BNC connector for video output
16	HDMI1	HDMI video output connector
17	VGA	DB-15 connector for VGA output to display local video output and menu
18	LAN1	Connector for LAN (Local Area Network)
19	Alarm In	Connectors for alarm inputs
20	Ground	Connect before powering up

**NOTE:** When HD-TV1 input is connected, information including resolution and frame rate (e.g., "720p25") is overlaid on bottom right corner of live view for five seconds for supported cameras.

When there is no video signal for the channel, the connectable video signal type message will not be displayed on the screen.

When an unsupported signal input is connected, no video message is displayed on the screen. Refer to the specifications for the supported resolution of the analog signal input types.

# 1.3. Menu Tree

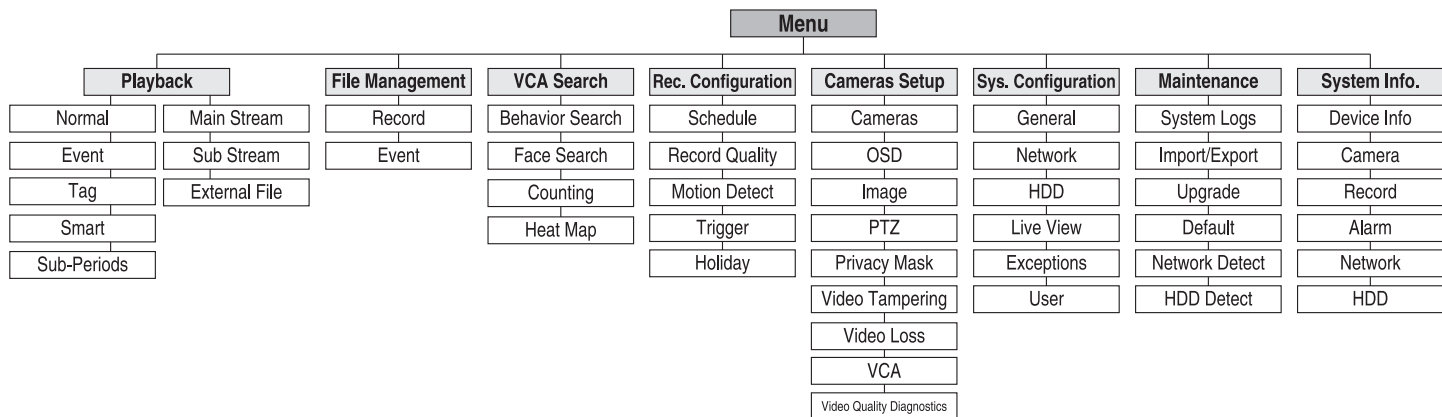



## 2. IR Remote Control Operations

The DVR may also be controlled with the included IR remote control. The keys on the remote control closely resemble the ones found on the front panel.

**NOTE:** Batteries (2 × AAA) must be installed before operation.

Table 1.1, Description of the IR Remote Control Buttons

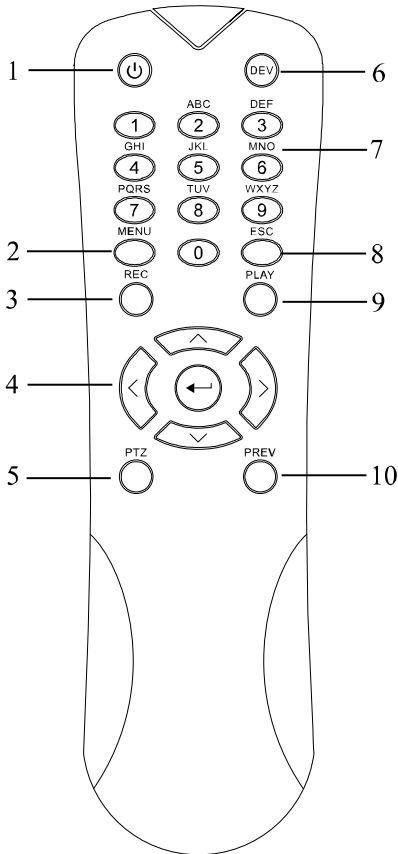

No.	Name	Description
1	<b>POWER</b>	Power on/off the device
		Power on/off the device by pressing and holding button 5 seconds
2	<b>MENU Button</b>	Press the button to return to the main menu after successful login
		Press and hold button for 5 seconds to turn off audible key beep
		In PTZ Control mode, MENU button will start wiper (if applicable)
		In Playback mode, shows/hides the control interface
3	<b>REC Button</b>	Enters Manual Record setting menu
		In PTZ control settings, press button and then call a PTZ preset by pressing numeric button
		Also used to turn audio on/off in Playback mode
4	<b>DIRECTION Button</b>	Navigate between different fields and items in menus
		In Playback mode, the Up and Down buttons are speed up and slow down recorded video. Left and Right buttons will select the next and previous record files.
		In Live View mode, buttons cycle through channels
		In PTZ control mode, controls movement of the PTZ camera
		<b>ENTER Button</b>
5	<b>PTZ Button</b>	Can also be used to <i>tick</i> checkbox fields.
		In Playback mode, plays or pauses the video
		In single-frame Playback mode, advance video a single frame
6	<b>DEV</b>	In Auto-switch mode, stops/starts auto switch
7	<b>Alphanumeric Buttons</b>	Enables/Disables Remote Control
		Switches to corresponding channel in Live View or PTZ Control mode
		Inputs numbers and characters in Edit mode
8	<b>ESC Button</b>	Switches between channels in the Playback mode
		Goes back to the previous menu
9	<b>PLAY Button</b>	Press to Arm/disarm the device in Live View mode
		Enters All-day Playback mode
10	<b>PREV Button</b>	Also auto scans in the PTZ Control menu
		Switches between single screen and multi-screen modes
		In PTZ Control mode, adjusts the focus in conjunction with the A/FOCUS+ button

### 2.1. Troubleshooting the Remote Control

**NOTE:** Make sure batteries have been installed properly in the remote control. Also note that the remote control must be aimed at the IR sensor on the DVR front panel.

If there is no response after you press any button on the remote, follow the procedure below to troubleshoot:

1. Go into Menu > Configuration > General > More Settings by using the front control panel or the mouse.

2. Check and remember the DVR No. (default is 255). This number is valid for all IR remote controls.
3. Press the DEV button on the remote control.
4. Enter the DVR No. noted in step 2.
5. Press the ENTER button on the remote.

If the Status indicator on the front panel turns blue, the remote control is operating properly. If the Status indicator does not turn blue and there is still no response from the remote, check the following:

1. Fresh, charged batteries are installed correctly and the polarities of the batteries are not reversed.
2. IR receiver is not obstructed.

If the remote still does function properly, change the remote and try again, or contact the device provider.

## 3. USB Mouse Operation

A regular 3-button (Left/Right/Scroll-wheel) USB mouse (wired or wireless) can also be used with this DVR.

### 3.1. Attach Mouse

1. Plug USB mouse into one of the USB interfaces on the front panel of the DVR.
2. The mouse should automatically be detected. If the mouse is not detected, the two devices may not be compatible. Refer to the recommended device list from your provider.

### 3.2. Mouse Operation

Name	Action	Description
Left-Click	Single-Click	Live view: Select channel and show the quick set menu Menu: Select and enter
	Double-Click	Live view: Switch between single-screen and multi-screen
	Drag	PTZ control: Wheeling Privacy mask and motion detection: Select target area Digital zoom-in: Drag and select target area Live view: Drag channel/time bar
Right-Click	Single-Click	Live view: Show menu Menu: Exit current menu to upper level menu
Scroll-Wheel	Scrolling Up	Live view: Previous screen Menu: Previous item
	Scrolling Down	Live view: Next screen Menu: Next item

## 4. Soft Keyboard

The on-screen keyboard allows you to enter characters.



Figure 4, Soft Keyboard

Icon	Description	Icon	Description
	Number		English letter
	Lowercase/Uppercase		Backspace
	Switch the keyboard		Space
	Positioning the cursor		Enter
	Symbols		Reserved

## 5. Getting Started

### 5.1. Starting Up and Shutting Down the DVR

Proper startup and shutdown procedures are crucial to extending the life of the DVR.

#### 5.1.1. Before Starting

Check that the voltage of the external power supply is the same with the DVR's requirement, and the ground connection is working properly.

#### 5.1.2. Starting the DVR

1. Check that the power supply is plugged into an electrical outlet. It is HIGHLY recommended that an Uninterruptible Power Supply (UPS) be used in conjunction with the device.
2. Turn on the power switch on the rear panel (16 channel only), and the Power indicator LED should turn on indicating that the unit is starting up.
3. After startup, the Power indicator LED remains on.

#### 5.1.3. Shutting Down the DVR

1. Enter the Shutdown menu, Menu > Maintenance > Shutdown (icon in lower left corner).



Figure 5, Shutdown Menu

2. Select the Shutdown button.
3. Click the Yes button.
4. Turn off the rear panel power switch (16 channel only) when the “Please Power Off” prompt appears.

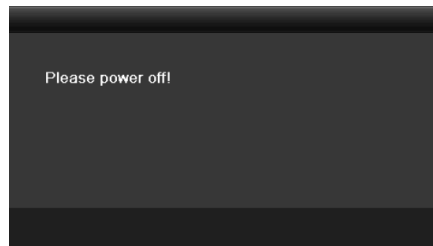

Figure 6, Shutdown Prompt

#### 5.1.4. Rebooting the DVR

While in the Shutdown menu, you can also reboot the DVR.

1. Enter the Shutdown menu by clicking Menu > Shutdown.
2. Click the Logout button to log out, or the Reboot button to reboot, the DVR.

## 5.2. Activating the Device

For first-time access, you must activate the device by creating an admin password. You can also activate the device via a Web browser, the SADP program, or client software.

1. Input the same password in the **Create New Password** and **Confirm New Password** fields.

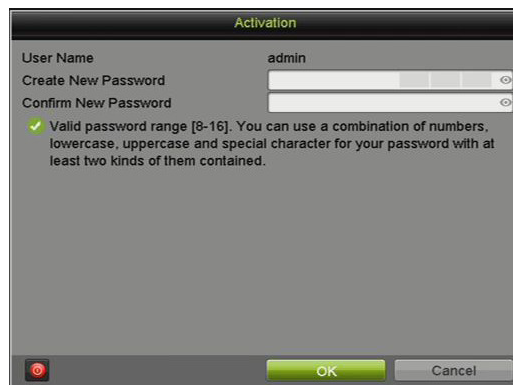



Figure 7, Setting Admin Password



## WARNING

**STRONG PASSWORD RECOMMENDED** – We highly recommend you create a strong password of your own choosing (using a minimum of 8 characters, including at least three of the following categories: upper case letters, lower case letters, numbers, and special characters.) in order to increase the security of your product. We also recommend that you reset your password regularly. Especially in a high security system, resetting the password monthly or weekly can better protect your product.

2. Click OK to save the password and activate the device.

**NOTE:** Clear-text password is supported. Click the  icon and you will see clear text of the password. Click the icon again and the password again becomes hidden.

If you update an old version to the new version, the following dialog box will pop up once the device starts up. Click YES and follow the prompts to set a strong password.



Figure 8, Password Reveal

3. After the device is activated, the Attention box pops up.



Figure 9, Attention

4. (Optional) Generate and save a GUID (Globally Unique Identifier) password recovery key to be used to reset the password. (The GUID (also known as a password key) is unique to each machine..

- 1) Insert a USB flash disk into the DVR's USB port.

- 2) Click the **Yes** button to export the GUID password recovery key. The Reset Password interface pops up.
- 3) Navigate to the USB flash disk.
- 4) Click the **New Folder** button to create a folder on the USB flash disk. If saving the GUID from multiple machines, create a name for the folder that identifies the machine (e.g., “Jones Home, PO3243...”).
- 5) Double click on the new folder to switch to that location for saving.
- 6) Click the **Export** button to export the GUID file to the USB flash disk. The system will show the saved GUID file.

**NOTE:** The first nine digits after GUID\_ is the serial number of the unit from which the GUID was exported. Digits after the serial number are the date of export.

If multiple GUIDs exist for the same unit, always use the file with the latest date.

A GUID can be used only once. Generate and export a new GUID once the issued GUID has been used.

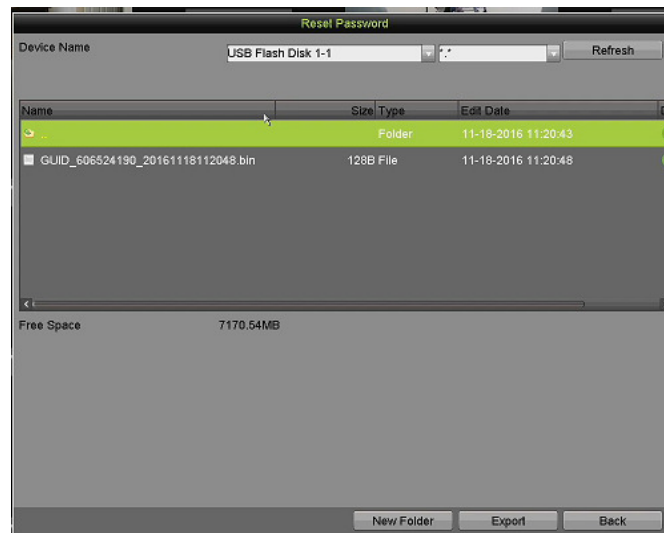

Figure 10, Export GUID File

## 6. Using the Unlock Pattern for Login

Configure the unlock pattern for device login by the admin.

### 6.1. Configuring the Unlock Pattern

After the device is activated, you can enter the following interface to configure the device unlock pattern.

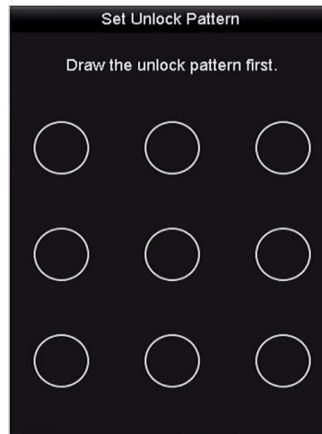

Figure 11, Set Unlock Pattern

1. Use the mouse to draw a pattern among the nine dots on the screen. Release the mouse when the pattern is done.

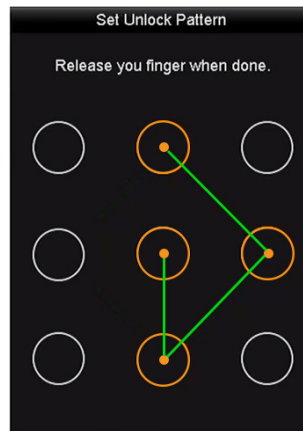

Figure 12, Draw the Pattern

**NOTE:** Connect at least four dots to draw the pattern. Each dot can be connected once only.

2. Draw the same pattern again to confirm it. When the two patterns match, the pattern is configured successfully.

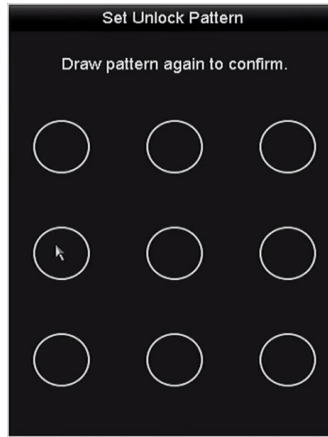

Figure 13, Confirm the Pattern

**NOTE:** If the two patterns are different, you must set the pattern again.

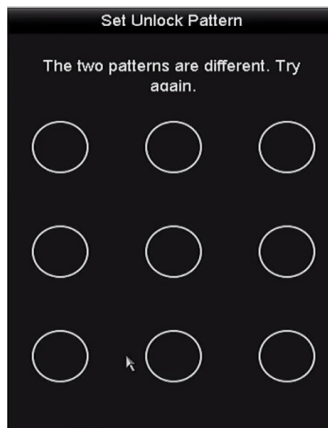

Figure 14, Reset the Pattern

## 6.2. Logging in via Unlock Pattern

**NOTE:** Only the *admin* user has permission to unlock the device. Configure the pattern before unlocking.

1. Right click the mouse on the screen and select the menu to enter the interface.

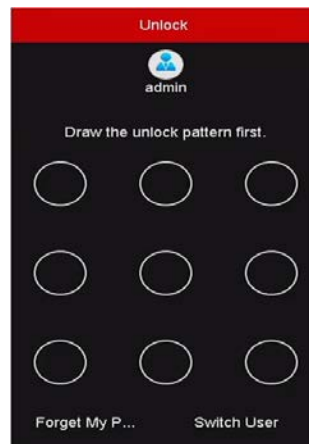

Figure 15, Draw the Unlock Pattern



2. Draw the pre-defined pattern to unlock to enter the menu operation.

**NOTE:** Right click the mouse to log in via the normal mode.

If you have forgotten your pattern, select the Forget My Pattern or Switch User option to enter the normal login dialog box.

If the pattern you draw is different from the pattern you have configured, try again.

If you have drawn the wrong pattern seven times, the account will be locked for one minute.



Figure 16, Normal Login Dialog Box

## 7. Login and Logout

### 7.1. User Login

You must log in to the device before operating the menu and other functions

1. Select the User Name in the drop-down list.



Figure 17, Login Interface

2. Input the Password.
3. Click OK to log in.

**NOTE:** Clear-text password is supported. Click the  icon to see clear text of the password. Click the icon again to hide the password.

In the Login interface, for the admin, if you have entered the wrong password seven times, the account will be locked for 60 seconds. For an operator, if you have entered the wrong password five times, the account will be locked for 60 seconds.

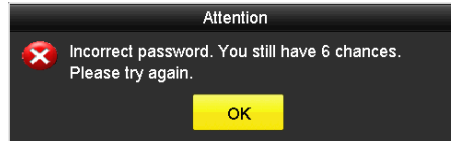

Figure 18, User Account Protection for the Admin

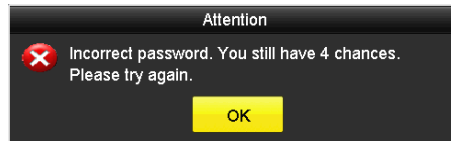

Figure 19, User Account Protection for the Operator

4. (Optional) If you forget the password, click Forget Password to pop up the Import GUID interface.

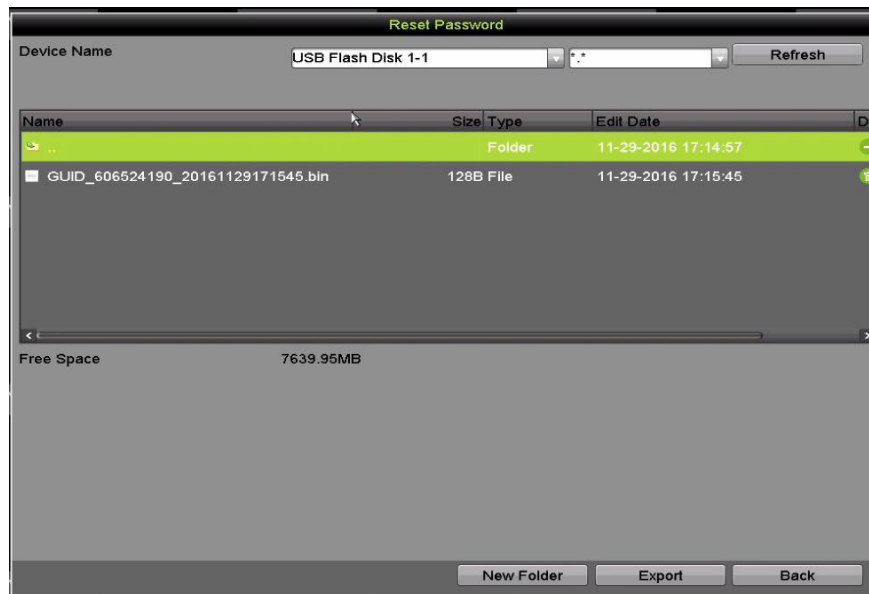

Figure 20, Import GUID File

5. Select the GUID file from the USB flash disk and click **Import** to display Reset Password interface.



Figure 21, Reset Password

6. Input the new password and confirm the password.
7. Click OK to save the new password. Then the Attention box pops up as shown below.



Figure 22, GUID File Imported

8. Click the **OK** button, and the Attention box pops up to remind you to duplicate the password of the device to IP cameras that are connected with default protocol. Click **Yes** to duplicate the password or **No** to cancel it.



Figure 23, Duplicate the Password

**NOTE:** If you want to retrieve the password when you forget it, you must export the GUID file first.

Once the password has been reset, the GUID file becomes ineffective. You can export a new GUID file.

## 7.2. User Logout

After logging out, the monitor turns to live view mode, and if you want to perform some operations, you will need to enter the user name and password to log in again.

1. Enter the Shutdown menu, Menu > Shutdown.



Figure 24, Logout

2. Click Logout.

**NOTE:** After you have logged out of the system, menu operations on the screen are invalid. Input a user name and password to unlock the system.

## 8. Adding Cameras

### 8.1. Analog Cameras

#### 8.1.1. Adding Analog Cameras

Analog cameras are enabled by default; no further action is required.

#### 8.1.2. Disabling Analog Cameras To Increase Number of IP Cameras

**NOTE:** Disabling an analog camera allows substitution of a network (IP) camera in its place, up to 10 IP cameras maximum for DS-7308HUHI-F4/N and up to 18 IP cameras maximum for DS-7316HUHI-F4/N.

1. Go to MENU > CAMERAS > ANALOG (TAB).
2. Analog Camera List will display all enabled cameras.
3. Disable analog cameras in the Analog Cameras Enable Status section:
  - Uncheck the **camera** checkbox of any camera(s) you wish to disable.
  - Check the **Analog** checkbox to disable/enable all analog cameras.
4. Press APPLY to save settings.

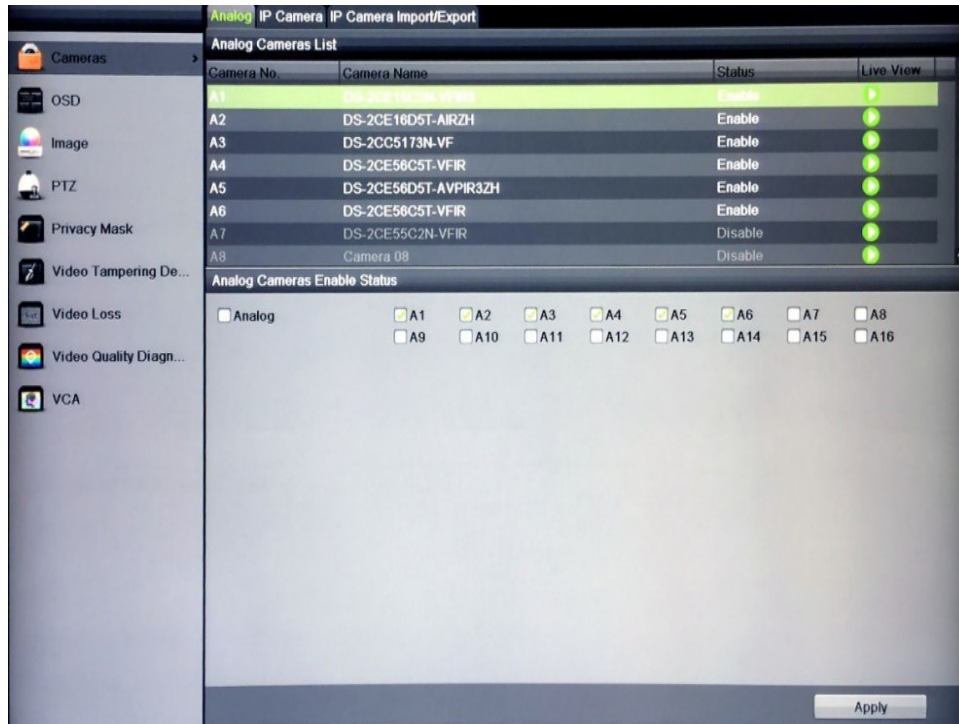

Figure 25, Add Analog Cameras Window

## 8.2. IP Cameras

### 8.2.1. Adding IP Cameras

**NOTE:** DS-73xxHUHI-F4/N DVRs support IP cameras up to 8 MP.

1. Go to MENU > CAMERAS > IP CAMERA (TAB).
2. Press the REFRESH button to update the camera list:
  - Cameras listed in yellow are cameras that have been detected on the network, but not added to view on the DVR.
  - Cameras listed in white are cameras that have been added to view on the DVR.

**NOTE:** If the camera you want to add does not appear on the list, make sure it is on the same network as the DVR. If it is on the same network, you can add the camera manually by pressing the CUSTOM ADDING button to display the Add IP Camera (Custom) window (Figure 27).

3. Fill out all relevant information and press the **OK** button.

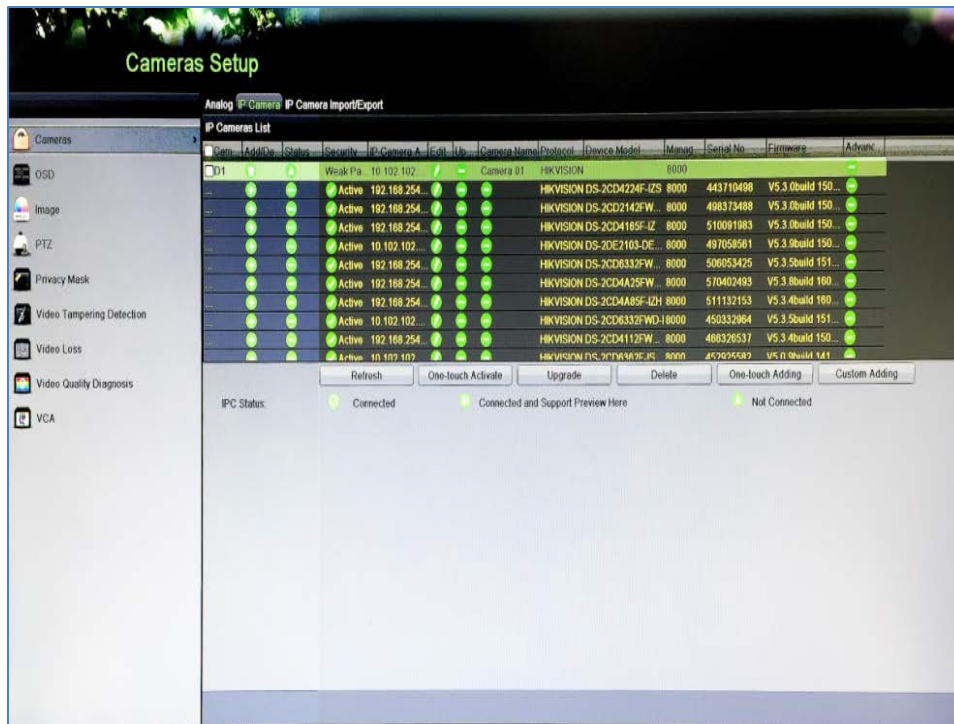



Figure 26, Cameras Setup: IP Camera

- To add a camera(s) to the DVR: Click the  icon next to an active (yellow highlighted) camera to add a single camera to the DVR
- Click the One-Touch Adding button to add all active (yellow highlighted) cameras to the DVR
- The DVR will check the IP camera's password against its own password:
- **If the IP Camera's and DVR's Passwords Match** — Camera name will turn white and the camera will be added to the DVR.
- **If the IP Camera's and DVR's Passwords Do Not Match** — The cameras will be added with incorrect passwords and will be locked. If the password of the camera does not match the password of the NVR see Custom Adding IP Camera section, below.

**NOTE:** If the camera has not been activated, you will be prompted to activate it by assigning a secure password. See Activating Camera, above.

### 8.2.2. Custom Adding IP Camera

If the camera you want to add does not appear on the list, add the camera as follows:

1. Press the **CUSTOM ADDING** button to add the camera manually.
2. In the Add IP Camera (Custom) window, enter the following information:
  - IP Camera Address
  - Protocol
  - Management Port
  - User Name
  - Admin Password
3. Press **Add** button.

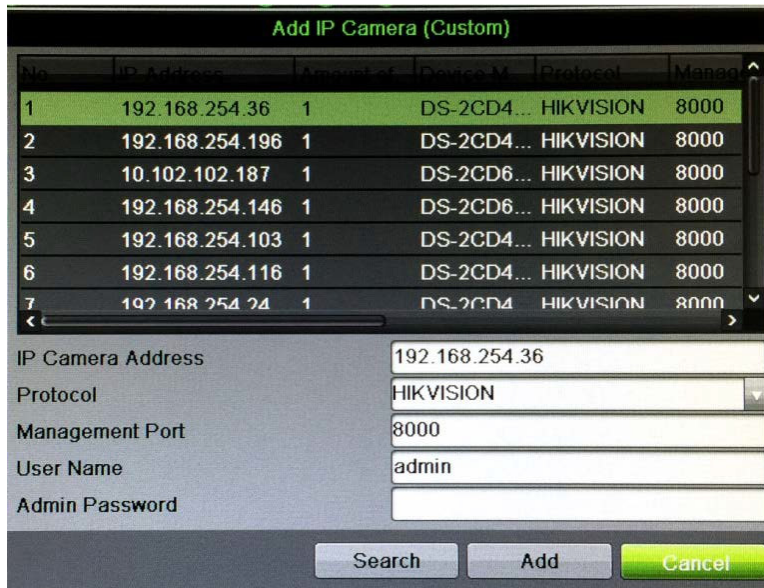











Figure 27, Add IP Camera (Custom) Window

### 8.2.3. Modify IP Camera Settings

1. Go to MENU > CAMERAS > IP CAMERA.
2. Click the following icons to manage cameras:

**NOTE:** To change camera name, go to OSD.

## IP Camera Management Icons

Icon	Explanation	Icon	Explanation
	EDIT (Pen): Press to edit basic IP camera parameters (must be in LAN2 range)		ADD (+): Press to add the detected IP camera
	DISCONNECTED (!): Camera is disconnected; click the icon to get camera's exception information		DELETE (Trash Can): Press to delete the camera
	PLAY (Right Triangle): Play connected camera's live video		ADVANCED (Gear): Press to go to advanced settings window.
	UPGRADE (Up Arrow): Upgrade the connected camera's firmware		DASH: No advanced settings available for this camera
	REPAIR (?): Press to attempt to repair the connection	Security Column	SECURITY: Shows camera status (active/inactive) or password strength (strong/medium/weak/risky)

### 8.2.4. Upgrade Camera Firmware

1. Download the appropriate firmware from [www.hikvision.com](http://www.hikvision.com).
2. Unzip (extract) the firmware onto a USB stick.
3. Check the checkboxes next to each camera you would like to upgrade.
4. Click the Upgrade button.
5. Browse to find the firmware file to be used for the upgrade.
6. Click OK.

### 8.2.5. Advanced Settings

1. Click the  Advanced icon to display the Advance Settings window.

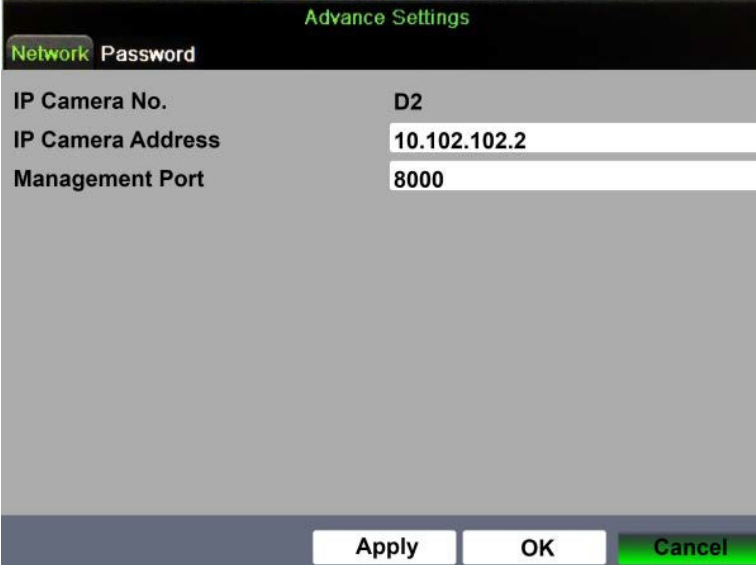

The screenshot shows a window titled "Advance Settings" with a "Network" tab selected. The "Password" tab is also visible. The network configuration fields are as follows:

Field	Value
IP Camera No.	D2
IP Camera Address	10.102.102.2
Management Port	8000

At the bottom of the window, there are three buttons: "Apply", "OK", and "Cancel".

Figure 28, Advanced Settings: Network

2. Enter information into the following fields, as appropriate:



- IP Camera No. (Read Only) — Displays the camera number
  - IP Camera Address — Enter the camera IP address
  - Management Port — Enter the camera management port (default = 8000)
3. Click the Password tab to display the Password window.

The screenshot shows a web interface titled "Advance Settings" with a "Password" tab selected. The "IP Camera No." field is populated with "D2". Below it are three input fields for "Current Password", "New Password", and "Confirm". A green checkmark icon is positioned to the left of a validation message: "Valid password range [8-16]. You can use a combination of numbers, lowercase, uppercase and special character for your password with at least two kinds of them contained." At the bottom of the window are three buttons: "Apply", "OK", and "Cancel".

Figure 29, Advanced Settings: Password

4. Enter current password in Current Password field.
5. Enter new password in New Password field.
6. Re-type new password in Confirm field.
7. Click on the Apply button to validate the new password
8. Click the OK button to accept the new password.

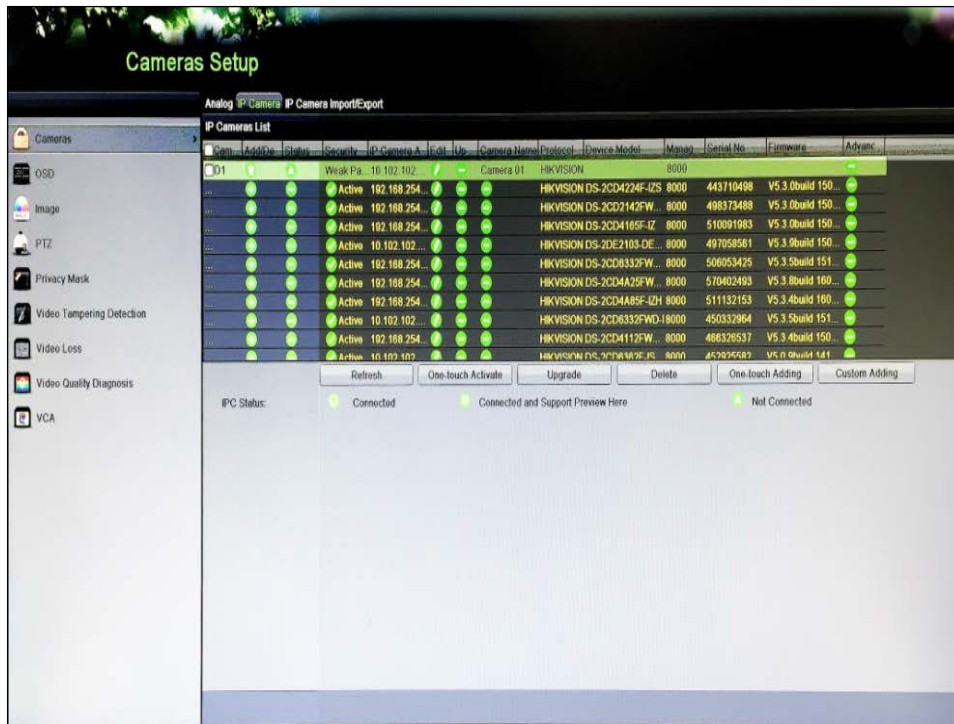

Figure 30, Cameras Setup > IP Camera Screen

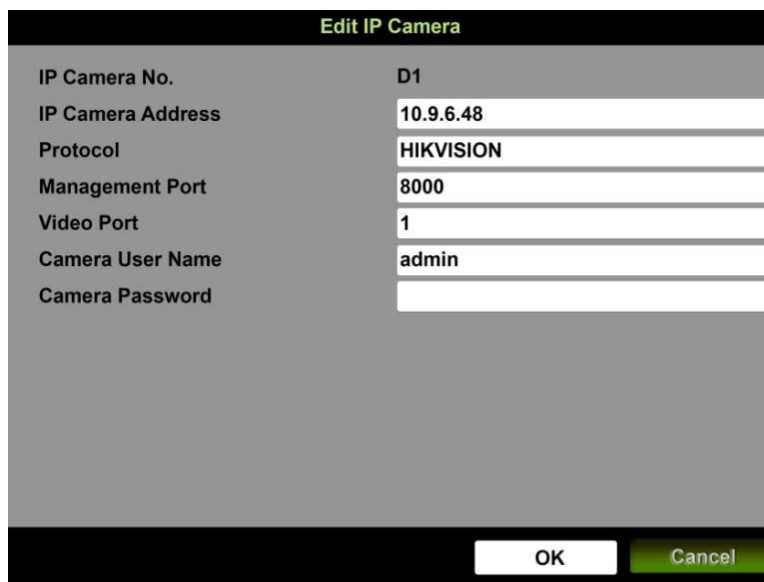

Figure 31, Edit IP Camera

### 8.3. Activating Camera

A camera must be activated before first use. To activate a camera before adding it to the DVR:

1. View the status of the camera in the Camera List “Security” column.
  - **Active** — Camera has been activated; no further activation necessary
  - **Inactive** — Camera is inactive; it must be activated before adding it to the DVR
  - **Strong/Medium/Weak/Risky** — Displays the camera’s password strength

2. Press One Touch Activate button.
  - Activation message will appear on the screen prompting user to activate the device (Figure 32).
  - Username field will be greyed-out with the username set to “admin.”
3. Type a password of your choosing (see “Password Strength Levels” table for guidelines).
  - The password strength will be displayed, accompanied by a color indicator.
  - Activation will not be allowed unless password is of acceptable strength.
4. Retype the password into the “Confirm Password” field.

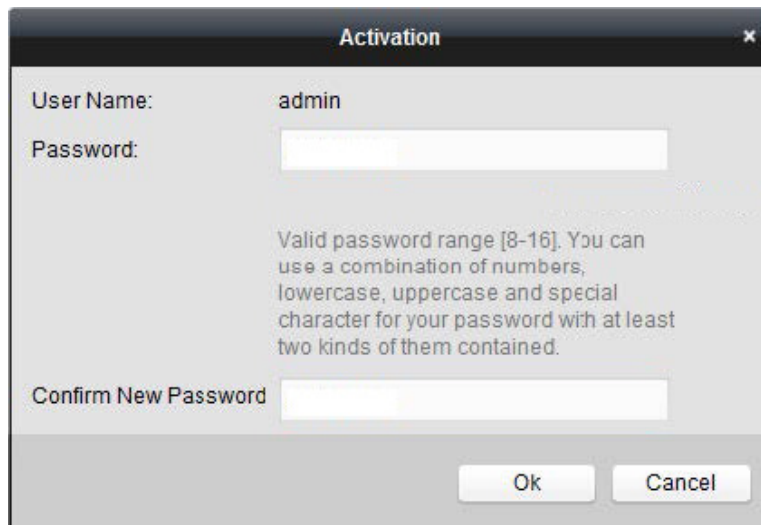

Figure 32, Activation Window

**NOTE:** The strength level indicator colors can vary by activation process, model number, and device type.

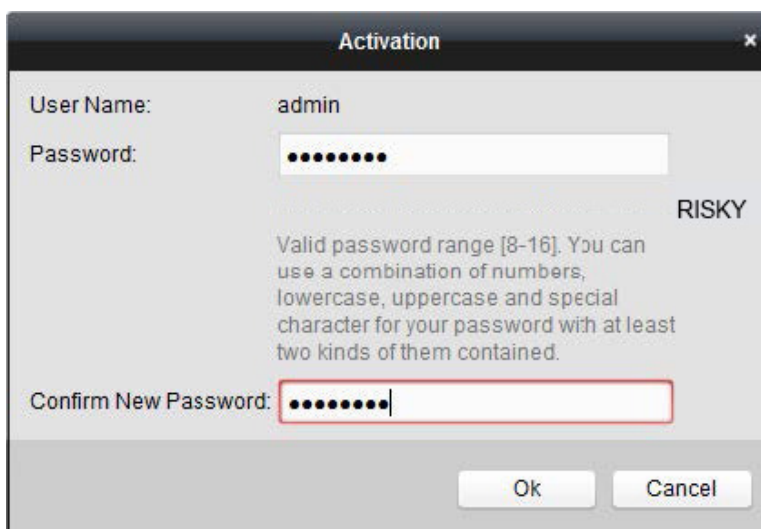

Figure 33, Level 0 (Inadequate) Strength Password

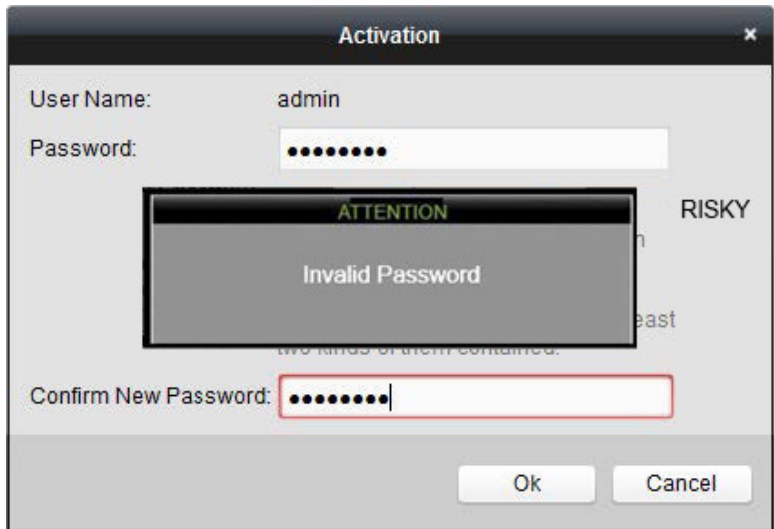

Figure 34, Invalid Password Message

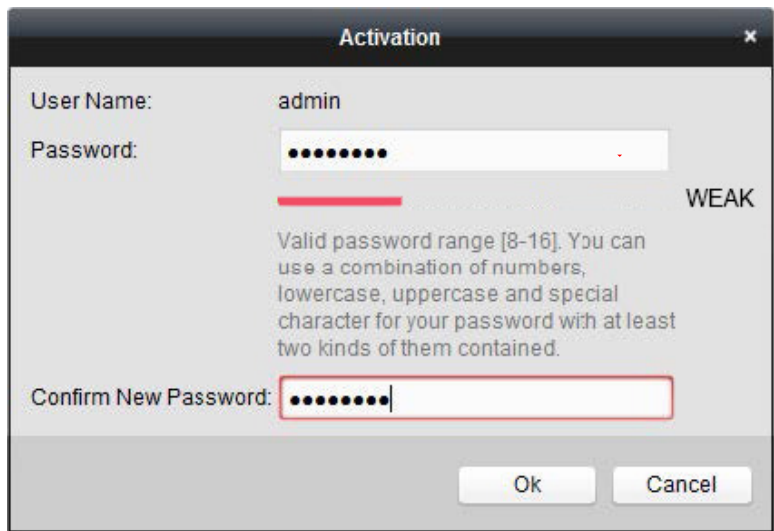

Figure 35, Level 1 Password Strength

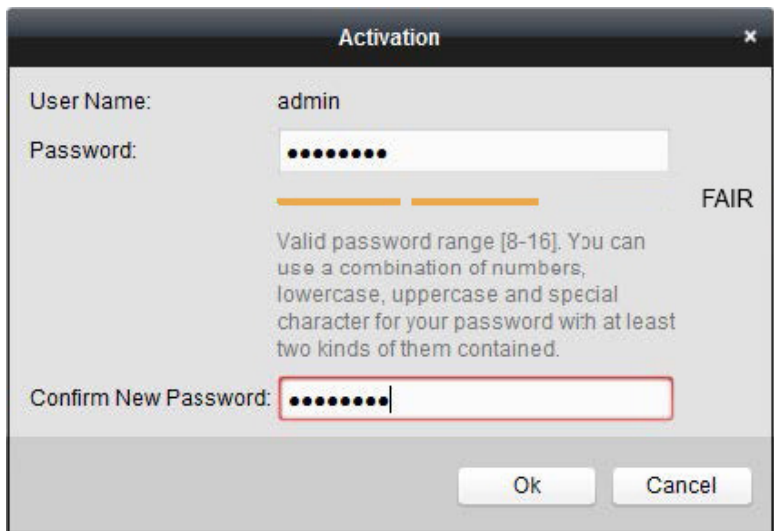

Figure 36, Level 2 Password Strength

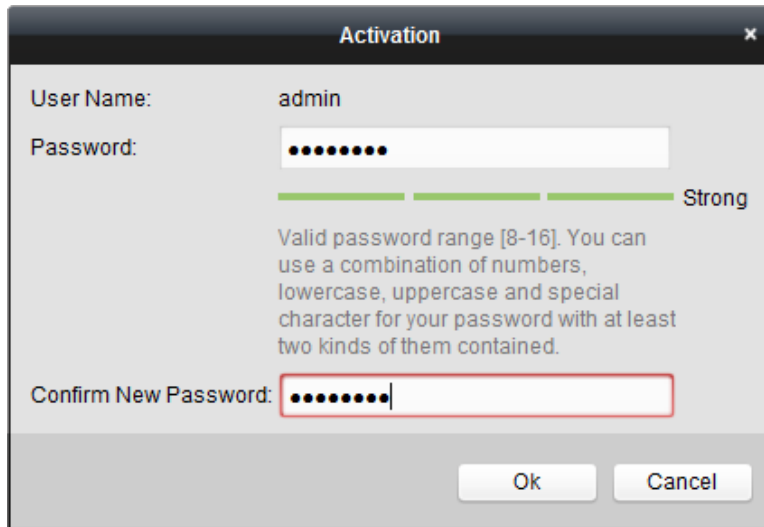

Figure 37, Level 3 and Level 4 Password Strength

5. After an acceptable password has been created, a confirmation message will appear (Figure 38).
6. Press the OK button to proceed.

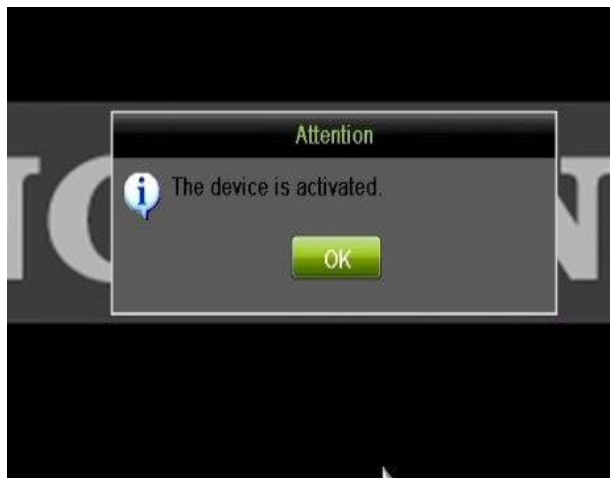

Figure 38, Activation Confirmation Message

## Password Strength Levels

STRENGTH LEVEL	DESCRIPTION
<b>Level 0 (Risky)</b> DVRs <i>will not</i> accept a Level 0 password	Password length is fewer than eight characters, contains only one type of character, is the same as the user name, and/or is the mirror writing of the user name. This type of password <i>will not</i> be accepted.
<b>Level 1 (Weak)</b> DVRs <i>will</i> accept a Level 1 password	Password contains two kinds of characters. The combination is number + lowercase letter or number + uppercase letter, and the password length is at least eight characters. This type of password <i>will</i> be accepted.
<b>Level 2 (Medium/Fair)</b> DVRs <i>will</i> accept a Level 2 password	Password contains two types of characters. The combination is neither number + lowercase letter <i>nor</i> number + uppercase letter, and the password length is at least eight characters. This type of password <i>will</i> be accepted.
<b>Level 3 (Strong)</b> DVRs <i>will</i> accept a Level 3 password	Password contains more than three types of characters, and the password length is at least eight characters. This type of password <i>will</i> be accepted.

**NOTE 1:** The strength level indicator colors can vary by activation process, model number, and device type. Typical: Risky (no color), Weak (pink), Fair (yellow), Strong (green).

**NOTE 2:** PASSWORD CHARACTERS ALLOWED (ASCII Only):

- Lowercase ASCII Letters  
a b c d e f g h i j k l m n o p q r s t u v w x y z
- Uppercase ASCII Letters  
A B C D E F G H I J K L M N O P Q R S T U V W X Y Z
- Numerals  
0 1 2 3 4 5 6 7 8 9
- Special Characters  
. - \_ : / @ , ? ! ' ( ) \$ & " [ ] { } # % ^ \* + = \ | < >

## 9. Live View

Live View shows the video image from each camera in real time. The DVR will automatically enter Live View mode when powered on. It is also at the very top of the menu hierarchy, thus hitting the ESC key multiple times (depending on which menu you're on) will take you back to Live View mode.

### 9.1. Live View Settings

#### 9.1.1. General

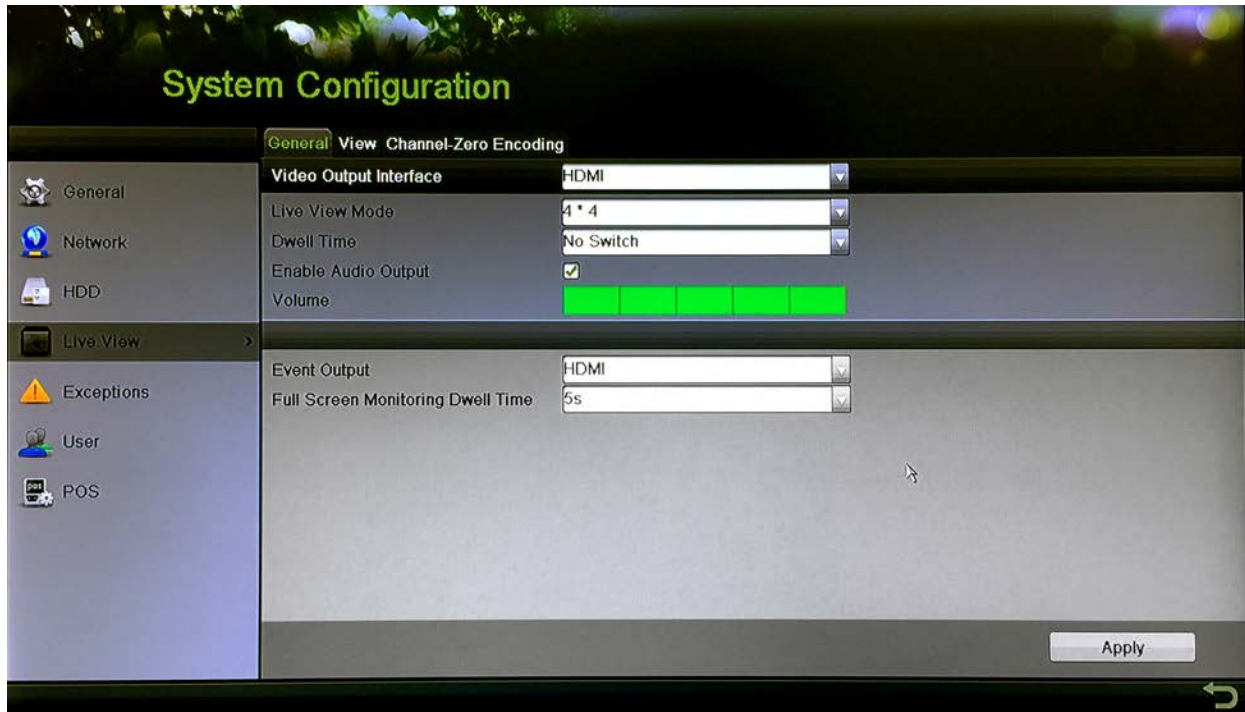

Figure 39, Live View Settings

1. Go to MENU > SYSTEM CONFIGURATION > LIVE VIEW > GENERAL.
2. Set the following values, as desired:
  - **Video Output Interface** – Use pull-down menu to select the monitor to use for Live View.
  - **Live View Mode** – Use pull-down menu to select the monitor view layout.
  - **Dwell Time** – Use pull-down menu to select the seconds to wait between Live View screens.
  - **Enable Audio Output** – Check to enable audio if the camera is so equipped.
  - **Volume** – Click on green squares to set volume.
  - **Event Output** – Use pull-down menu to select the monitor to use for events.
  - **Full Screen Monitoring Dwell Time** – Use pull-down menu to select the seconds to wait between the event monitor screens.

## 9.1.2. View

This section explains how to assign cameras to Live View screen positions.

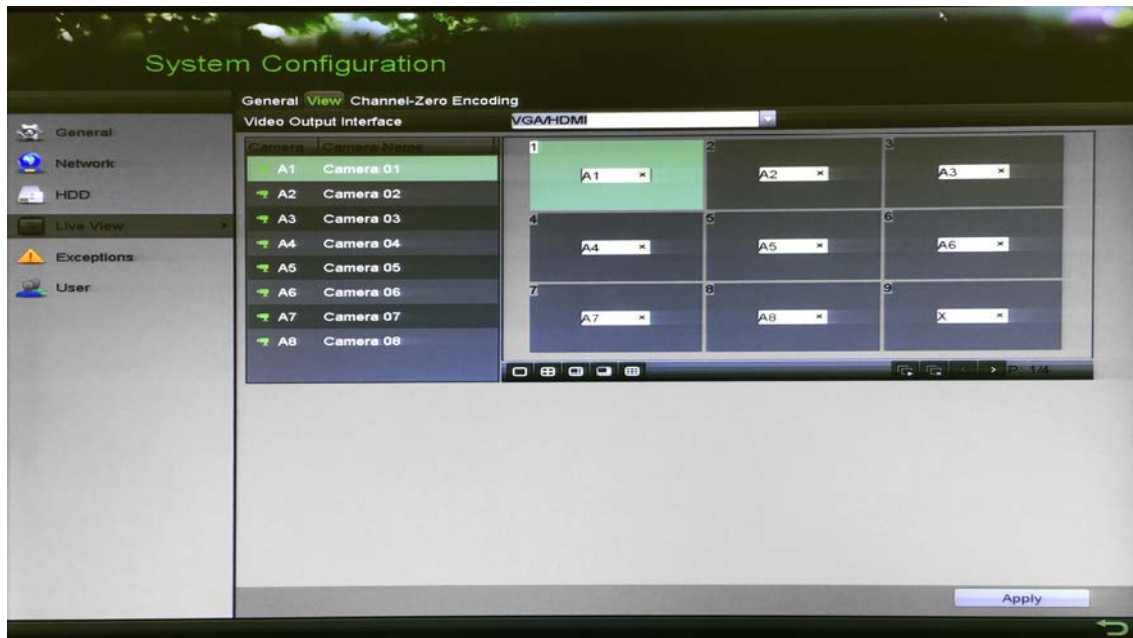

Figure 40, Live View View Settings

1. Go to MENU > SYSTEM CONFIGURATION > LIVE VIEW > VIEW.
2. Use pull-down menu to select the **Video Output Interface** you want to configure.
3. Click on a screen layout (directly beneath screen positions) that you want the monitor to have.
4. Highlight a screen position on the top right section of the screen.
5. Double click a camera on the camera list on the left of the screen to assign the camera to the highlighted screen position.
6. Repeat for all screen positions.
7. Press the **Apply** button.

## 9.1.3. Channel-Zero Encoding

Channel-Zero Encoding combines all video streams into one lower resolution, lower bandwidth channel. Do the following to enable Channel-Zero Encoding:

1. Go to MENU > SYSTEM CONFIGURATION > LIVE VIEW > CHANNEL-ZERO ENCODING.
2. Check the **Enable Channel-Zero Encoding** checkbox.
3. Use the pull-down menu to select the channel frame rate.
4. Use the pull-down menu to select the **Max.(imum) Bitrate Mode**.
5. Use the pull-down menu to select the **Max.(imum) Bitrate** in Kbps.
6. Press the **Apply** button.









Figure 41, Channel-Zero Encoding

#### 9.1.4. Live View Icons

In live view mode, there are icons at the right top of the screen for each channel, showing the status of the record and alarm in the channel, so that you can know whether the channel is recorded, or whether there are alarms as soon as possible.

Icons	Description
	Alarm (video loss, tampering, motion detection, VCA or sensor alarm)
	Record (manual record, schedule record, motion detection or alarm triggered record)
	Alarm & Record
	Event/Exception (motion detection, sensor alarm or exception information)

## 9.2. Operations in Live View Mode

In Live View mode, there are many functions provided. The functions are listed below.

- Single Screen: show only one screen on the monitor.
- Multi-screen: show multiple screens on the monitor simultaneously.
- Start Auto-Switch: the screen is auto switched to the next one. You must set the dwell time for each screen on the configuration menu before enabling the auto-switch. Menu > Configuration > Live View > Dwell Time.
- Start Recording: normal record and motion detection record are supported.
- Output Mode: select the output mode to Standard, Bright, Gentle, or Vivid.
- Playback: play back the recorded videos for the current day.

- Aux/Main Monitor: the DVR checks the connection of the output interfaces to define the main and auxiliary output interfaces. When the aux output is enabled, the main output cannot do any operation, and you can do some basic operation on the live view mode for the Aux output.

The VGA/HDMI output is the main output. The priority relationship is shown in the following table:

S.N	HDMI	VGA	Main Output
1	√ or x	√ or x	VGA/HDMI

**NOTE:** √ means the interface is in use, x means the interface is out of use or the connection is invalid. HDMI and VGA can be used at the same time.

### 9.3. Using the Mouse in Live View

Refer to the following table for the description of mouse operations in Live View mode:

Name	Description
<b>Menu</b>	Enter the main menu of the system by right clicking the mouse
<b>Single Screen</b>	Switch to the single full screen by choosing channel number from the drop-down list
<b>Multi-Screen</b>	Adjust the screen layout by selecting from the drop-down list.
<b>Previous Screen</b>	Switch to the previous screen
<b>Next Screen</b>	Switch to the next screen
<b>Start/Stop Auto-Switch</b>	Enable/disable the auto-switch of the screens <b>NOTE:</b> The <i>dwelling time</i> of the live view configuration must be set before using Start Auto-Switch
<b>Start Recording</b>	Start recording all channels; Continuous Record and Motion Detection Record are selectable from the drop-down list
<b>Add IP Camera</b>	A shortcut to enter the IP camera management interface. (For HDVR series only)
<b>Playback</b>	Enter the playback interface and start playing back the video of the selected channel immediately.
<b>PTZ Control</b>	Shortcut to enter the PTZ control interface of the selected camera
<b>Output Mode</b>	Output Mode is configurable with Standard, Bright, Gentle, and Vivid options

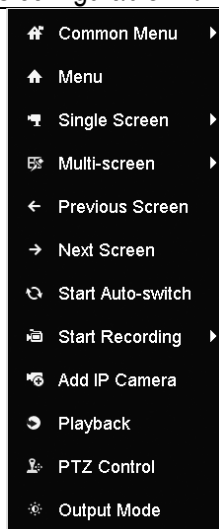

Figure 42, Right-Click Menu

## 9.4. Quick Setting Toolbar in Live View Mode

On each channel's screen, there is a quick setting toolbar that shows when you click the screen.

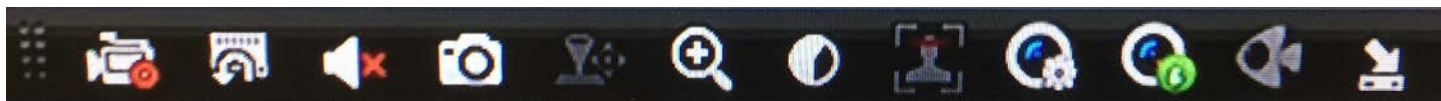



Figure 43, Quick Setting Toolbar

Icons	Description	Icons	Description	Icons	Description
	Start/Stop Manual Recording		Instant Playback		Audio On/Mute
	PTZ Control		Digital Zoom		Image Settings
	Close Live View		Face Detection		Information
	Capture		Live View Strategy		Information
	Fisheye				

-  Instant Playback shows only the record in last five minutes. If no record is found, it means there is no record during the last five minutes.
-  Digital Zoom can zoom in the selected area to the full screen. Click and draw to select the area to zoom in.

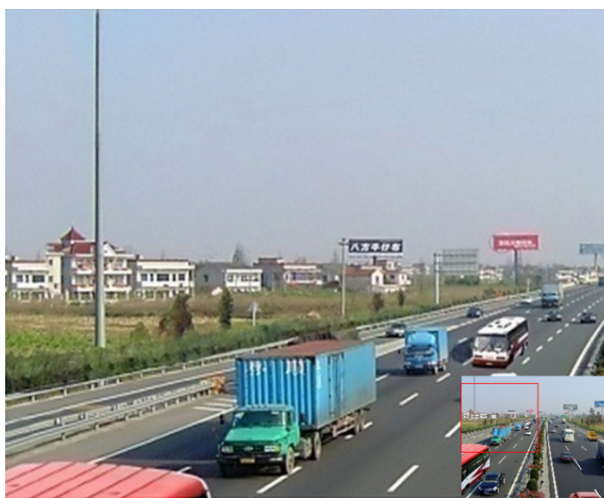



Figure 44, Digital Zoom

-  Image Settings icon can be selected to enter the Image Settings menu. You can drag the mouse or click  to adjust the image parameters, including brightness, contrast, and saturation..

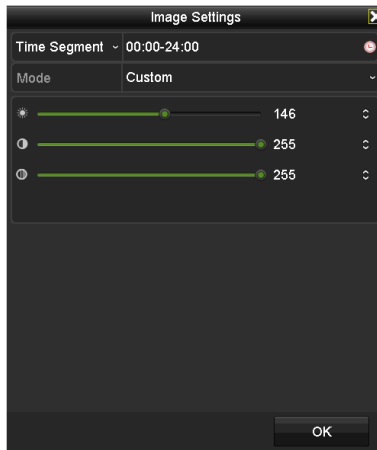

Figure 45, Image Settings



- 
 Face Detection can be enabled on supported cameras if you click the icon. The dialog pops up. Click **Yes** and the full-screen live view of the channel is enabled. You can click  to exit from the full-screen mode.



Figure 46, Enable Face Detection

**NOTE:** You can configure face detection only when it is supported by the connected camera.

- 
 Move the mouse onto the Information icon to show the real-time stream information, including the frame rate, bit rate, resolution, and stream type.

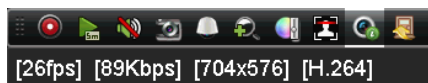

Figure 47, Information

## 9.5. Adjusting Live View Settings

Live View settings can be customized according to different needs. You can configure the output interface, dwell time for screen to be shown, mute or turning on the audio, the screen number for each channel, etc.

- Enter the Live View Settings interface, Menu > Configuration > Live View.



Figure 48, Live View – General (1)

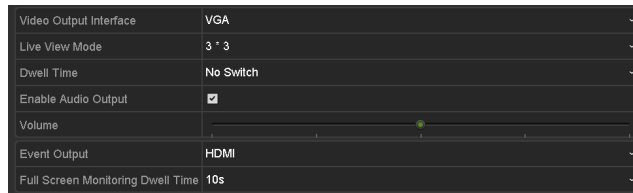

Figure 49, Live View – General (2)

The settings available in this menu include:





- **Video Output Interface:** Selects the output (HDMI, VGA, or 4K) to configure the settings to the video output interface.  
**NOTE:** Using 4K video output disables VGA output.
- **Live View Mode:** Selects the display mode to be used for Live View.
- **Dwell Time:** The time in seconds to dwell between switching of channels when enabling auto-switch in Live View.
- **Enable Audio Output:** Enables/disables audio output for the selected camera in the live view mode.
- **Volume:** Adjust the volume of the audio output.
- **Event Output:** Designates the output to show event video. If available, you can select a different video output interface from the Video Output Interface when an event occurs.
- **Full Screen Monitoring Dwell Time:** The time in seconds to show alarm event screen.

8. Set the camera order.

9. Click View tab and select the Video Output Interface from the drop-down list.



Figure 50, Live View, Camera Order

10. Click a window to select it, and then double-click a camera name in the camera list you would like to display. Setting an 'X' means the window will not display any camera.
11. You can also click  to start live view of all channels in order and click  to stop live view of all channels. Click  or  to go to the previous or next page.
12. Click the Apply button.

## 9.6. Manual Video Quality Diagnostics

The video quality of the analog channels can be diagnosed manually and you can view the diagnostic results from a list.

1. Enter the Manual Video Quality Diagnostics interface, Menu > Manual > Manual Video Quality Diagnostics.

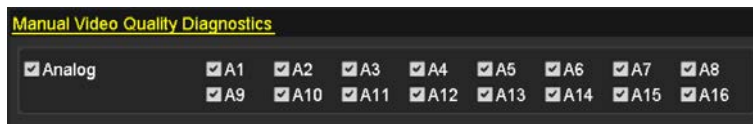

Figure 51, Video Quality Diagnostics

2. Check the checkboxes to select the channels for diagnostics.
3. Click the **Diagnose** button, and the results will be displayed in a list. You can view the video status and diagnostics time of the selected channels.

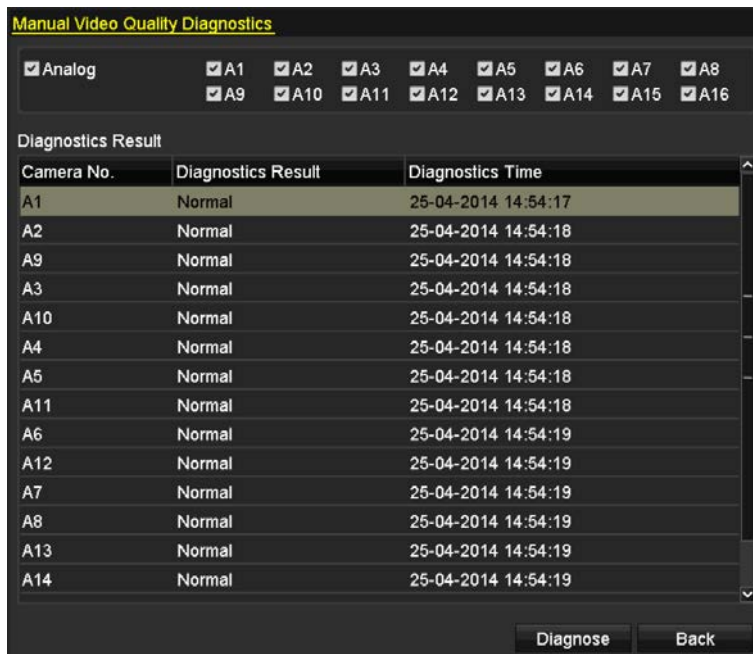

Figure 52, Diagnostics Result

**NOTE:** Connect the camera to the device for the video quality diagnostics.

Three exception types can be diagnosed: Blurred Image, Abnormal Brightness, and Color Cast.

# 10. PTZ Controls

## 10.1. Configuring PTZ Settings

Follow the procedure to set the parameters for PTZ. The configuring of the PTZ parameters should be done before you control the PTZ camera.

1. Enter the PTZ Settings interface, Menu > Camera > PTZ.



Figure 53, PTZ Settings

2. Select the camera for PTZ setting in the Camera drop-down list.
3. Click the PTZ Parameters button to set the PTZ parameters.



Figure 54, PTZ, General

4. Select the parameters of the PTZ camera from the drop-down list.

**NOTE:** All the parameters should be exactly the same as the PTZ camera parameters.

For a connected Coaxitron camera/dome, select the HIKVISION-C PTZ protocol. Make sure the protocol selected here is supported by the connected camera/dome.

If HIKVISION-C protocol is selected, all other parameters such as baud rate, data bit, stop bit, parity, and flow control are not configurable.

5. (Optional) Click Copy button to copy the settings to the other channels. Select the channels you want to copy to and click OK to return to the PTZ Parameters Settings interface.

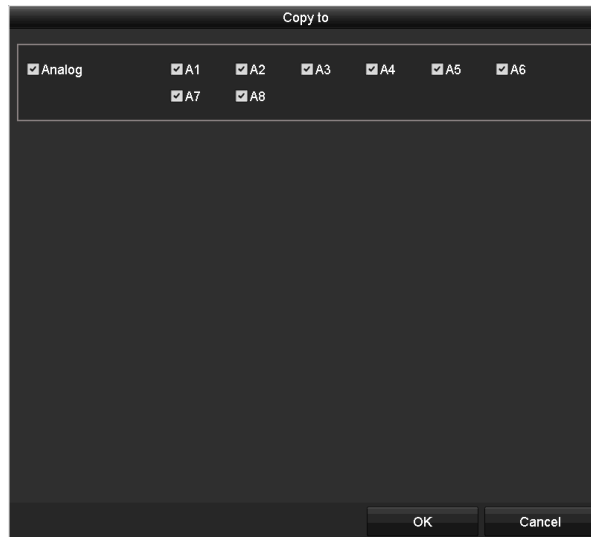

Figure 55, Copy to Other Channels

6. Click OK to save the settings.
7. (Optional) Check the Enable Omnicast Control checkbox to enable the PTZ control of the selected camera via Omnicast VMS of Genetec.

## 10.2. Setting PTZ Presets, Patrols, and Patterns

### 10.2.1. Before Starting

Please make sure that the presets, patrols, and patterns are supported by PTZ protocols.

### 10.2.2. Customizing Presets

Follow the steps to set the Preset location which you want the PTZ camera to point to when an event takes place.

1. Enter the PTZ Settings interface, Menu > Camera > PTZ.



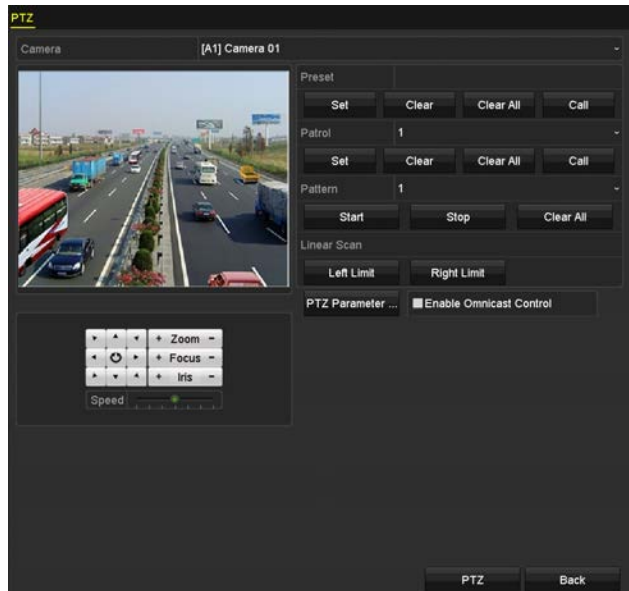



Figure 56, PTZ Settings

2. Use the directional button to point the camera to the location where you want to set the preset; the zoom and focus operations can be recorded in the preset as well.
3. Enter the preset No. (1 to 255) in the preset text field, and click the Set button to link the location to the preset.
4. Repeat steps 2 and 3 to save more presets.

**NOTE:** Click the Clear button to clear the location information of the preset, or click the Clear All button to clear the location information of all the presets.

### 10.2.3. Calling Presets

This feature enables the camera to point to a specified position such as a window when an event takes place.

1. Click the PTZ button in the lower-right corner of the PTZ setting interface, or press the PTZ button on the front panel, or click the PTZ Control icon  in the quick setting bar, or select the PTZ option in the right-click menu to show the PTZ control panel.
2. Choose Camera in the drop-down list.
3. Click the General tab to show the general settings of the PTZ control.

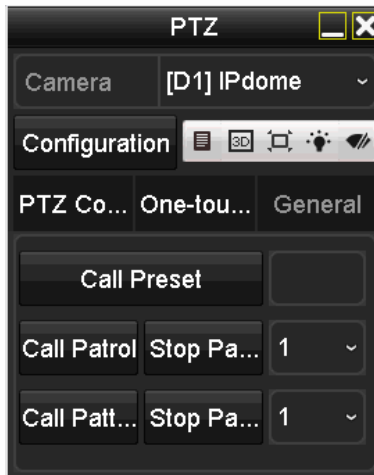

Figure 57, PTZ Panel, General

4. Click to enter the preset No. in the corresponding text field.
5. Click the Call Preset button to call it.

**NOTE:** When a Coaxitron camera/dome is connected and the PTZ protocol is selected to HIKVISION-C, call the preset 95 to enter the menu of the connected Coaxitron camera/dome. Use the directional buttons on the PTZ control panel to operate the menu.

#### 10.2.4. Customizing Patrols

Patrols can be set to move the PTZ to different key points and have it stay there for a set duration before moving on to the next key point. The key points are corresponding to the presets. The presets can be set following the steps above in *Customizing Presets*.

1. Enter the PTZ Settings interface, Menu > Camera > PTZ.



Figure 58, PTZ Settings

2. Select patrol No. in the drop-down list of patrol.

3. Click the Set button to add key points for the patrol.

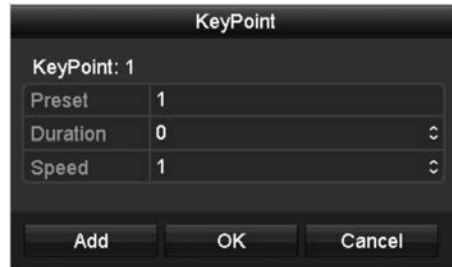

Figure 59, Key Point Configuration

4. Configure key point parameters such as the key point No., duration of staying for one key point, and speed of patrol.

**NOTE:** The key point corresponds to the preset. The Key Point No. determines the order the PTZ will follow while cycling through the patrol. Duration refers to the time to stay at the corresponding key point. Speed defines the speed at which the PTZ will move from one key point to the next.

5. Click the Add button to add the next key point to the patrol, or click the OK button to save the key point to the patrol.
6. You can delete all the key points by clicking the Clear button for the selected patrol, or click the Clear All button to delete all the key pints for all patrols.

### 10.2.5. Calling Patrols

Calling a patrol moves the PTZ according the predefined patrol path.

1. Click the PTZ button in the lower-right corner of the PTZ Settings interface, or press the PTZ button on the front panel, or click the PTZ Control icon  in the quick setting bar, or select the PTZ option in the right-click menu to show the PTZ control panel.
2. Click the General tab to show the general settings of the PTZ control.



Figure 60, PTZ Panel, General

3. Select a patrol in the dropdown list and click the Call Patrol button to call it.

4. You can click the Stop Patrol button to stop calling it.

### 10.2.6. Customizing Patterns

Patterns can be set by recording the movement of the PTZ. You can call the pattern to move the PTZ according to the predefined path.

1. Enter the PTZ Settings interface, Menu > Camera > PTZ.

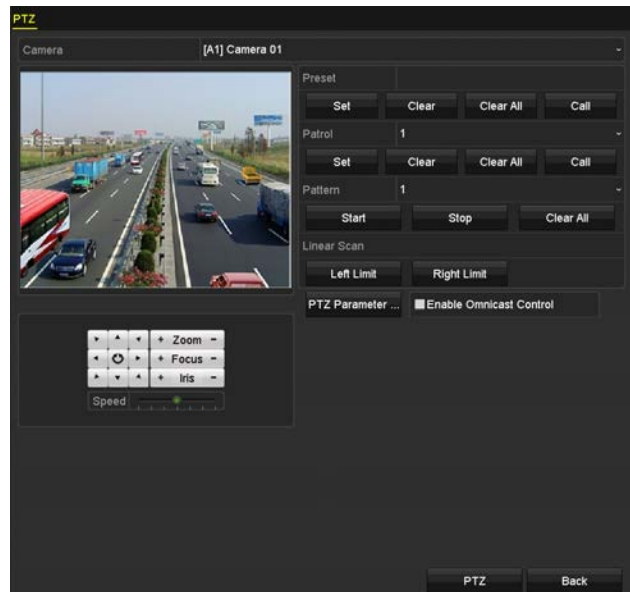



Figure 61, PTZ Settings

2. Choose pattern number in the drop-down list.
3. Click the Start button, and click corresponding buttons in the control panel, to move the PTZ camera. Click the Stop button to stop it. The PTZ movement is recorded as the pattern.

### 10.2.7. Calling Patterns

Follow the procedure to move the PTZ camera according to the predefined patterns.

1. Click the PTZ button in the lower-right corner of the PTZ Settings interface, or press the PTZ button on the front panel, or click the PTZ Control icon  in the quick setting bar, or select the PTZ option in the right-click menu to show the PTZ control panel.
2. Click the General tab to show the general settings of the PTZ control.

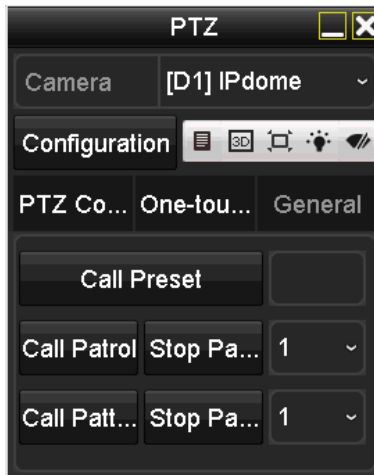

Figure 62, PTZ Panel, General

3. Click the Call Pattern button to call it.
4. Click the Stop Pattern button to stop calling it.

### 10.2.8. Customizing Linear Scan Limit

Enable Linear Scan to trigger the scan in the horizontal direction in the predefined range.

**NOTE:** This function is supported by certain models.

1. Enter the PTZ Settings interface, Menu > Camera > PTZ.

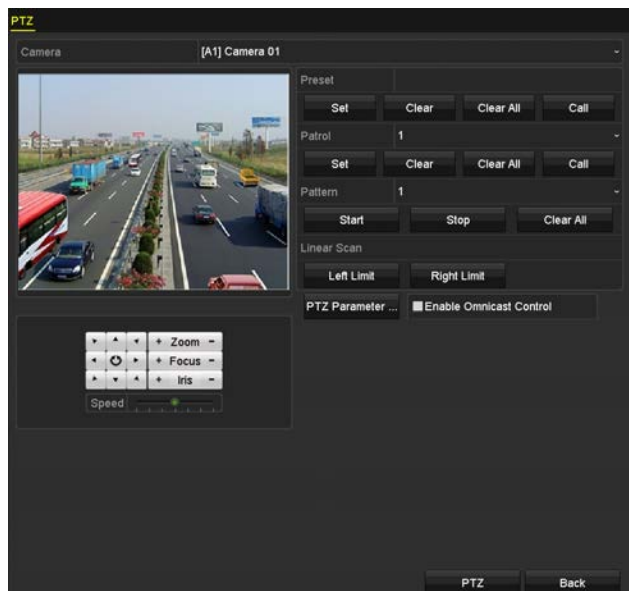

Figure 63, PTZ Settings

2. Use the directional button to wheel the camera to the location where you want to set the limit, and click the Left Limit or Right Limit button to link the location to the corresponding limit.

**NOTE:** The speed dome starts linear scan from the left limit to the right limit. The left limit must be left of the right limit. The angle from the left limit to the right limit must be no more than 180°.

### 10.2.9. Calling Linear Scan

Follow the procedure to call the linear scan in the predefined scan range.

1. Click the button PTZ in the lower-right corner of the PTZ Settings interface, or press the PTZ button on the front panel, or click the PTZ Control icon  in the quick setting bar to enter the PTZ setting menu in live view mode.
2. Click the One-Touch tab to show the one-touch function of the PTZ control.



Figure 64, PTZ Panel, One-Touch

3. Click Linear Scan button to start the linear scan and click the Linear Scan button again to stop it.
4. Click the Restore button to clear the defined left limit and right limit data, and the dome needs to reboot to have settings take effect.

### 10.2.10. One-Touch Park

Certain speed dome models can be configured to start a predefined park action (scan, preset, patrol, etc.) automatically after a period of inactivity (park time).

1. Click the PTZ button in the lower-right corner of the PTZ Settings interface. or press the PTZ button on the front panel, or click the PTZ Control icon  in the quick setting bar to enter the PTZ setting menu in live view mode.
2. Click the One-Touch tab to show the one-touch function of the PTZ control.



Figure 65, PTZ Panel, One-Touch

3. Click the corresponding button to activate the one-touch park action:
  - **Park (Quick Patrol):** The dome starts patrol from the predefined preset 1 to preset 32 in order after the park time. Any undefined preset will be skipped.
  - **Park (Patrol 1):** The dome starts moving according to the predefined patrol 1 path after the park time.
  - **Park (Preset 1):** The dome moves to the predefined preset 1 location after the park time.

**NOTE:** The park time can be set only through the speed dome configuration interface. The default value is 5s.

4. Click the button again to inactivate it.

#### 10.2.11. PTZ Control Panel

1. Enter the PTZ control panel in one of two ways:
  - **OPTION 1:** In the PTZ Settings interface, click the PTZ button on the lower-right corner next to the Back button.
  - **OPTION 2:** In Live View mode, press the PTZ Control button on the front panel, or on the remote control, or choose the PTZ Control icon  in the quick setting bar, or select the PTZ Control option in the right-click menu.
2. Click the Configuration button on the control panel to enter the PTZ Settings interface.

**NOTE:** In PTZ control mode, the PTZ panel will be displayed when a mouse is connected to the device. If no mouse is connected, the  icon appears in the lower-left corner of the window, indicating that this camera is in PTZ control mode.

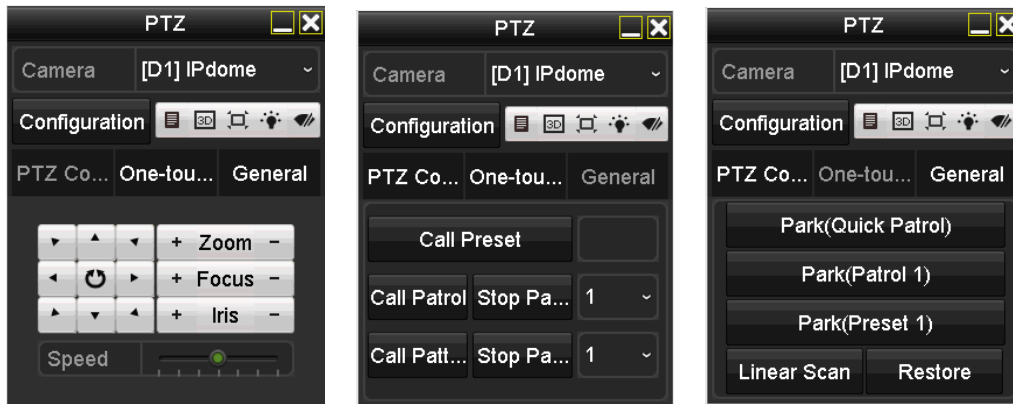

Figure 66, PTZ Control Panel

### Description of the PTZ Panel Icons

Icon	Description	Icon	Description	Icon	Description
	Direction button and the auto-cycle button		Zoom+, Focus+, Iris+		Zoom-, Focus-, Iris-
	The speed of the PTZ movement		Light on/off		Wiper on/off
	3D-Zoom		Image Centralization		Menu
	Switch to the PTZ control interface		Switch to the one-touch control interface		Switch to the general settings interface
	Exit		Minimize windows		



# 11. Recording Settings

## 11.1. Configuring Encoding Parameters

### 11.1.1. Before Starting

1. Make sure that the HDD has been installed. If not, install an HDD and initialize it by going to Menu > HDD > General.

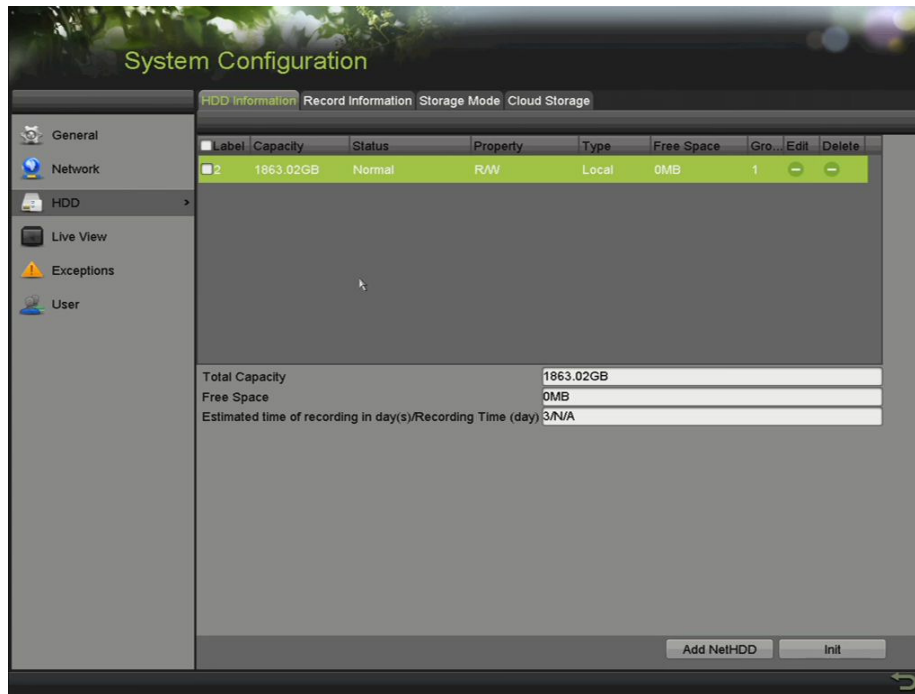

Figure 67, HDD, General

2. Click the Advanced tab and select HDD storage mode (Menu > HDD > Advanced > Storage Mode).
  - If the HDD mode is *Quota*, set the maximum record capacity.
  - If the HDD mode is *Group*, set the HDD group.

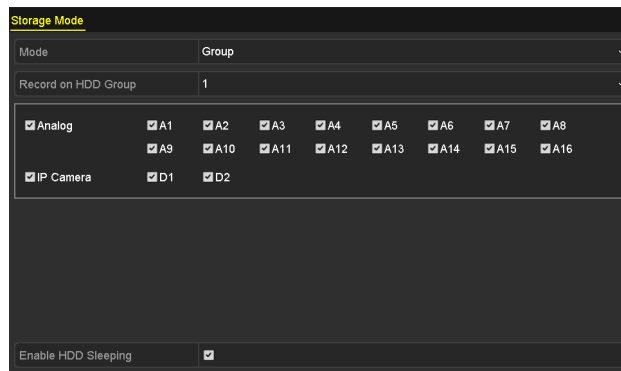

Figure 68, HDD, Advanced

3. Enter the Record Parameters interface to configure the encoding parameters, Menu > Record > Parameters.



Figure 69, Record Parameters

4. Set the parameters for recording.
  - A). Select the Record tab to configure.
  - B). Select a camera from the camera drop-down list.
  - C). View the Camera Resolution.

**NOTE:** When HD-TVI input is connected, you can view the information including the input signal type, resolution, and frame rate (e.g., HD-TVI 720P25).

5. Configure the following parameters for the Main Stream (Continuous) and the Main Stream (Event): Stream Type: Set the stream type to be Video or Video & Audio.
6. Resolution: Set recording resolution.

**NOTE:** Supports up to 3 MP resolution (up to 8 MP resolution for IP cameras). If a 3 MP signal input is connected to the channel, the recording resolution will be adjusted to 3 MP (8 MP if 8 MP IP camera) and the frame rate will be adjusted to 12 fps automatically if the resolution and frame rate are not configured manually.

If the 3 MP camera is connected to a channel that supports up to 1080p signal input, it will switch to 1080p signal input. When the 3 MP signal is switched to 1080p signal, PAL will be switched to 1080p/25 Hz and NTSC will be switched to 1080p/30 Hz.

Analog signal inputs including HD-TVI (including 3 MP, 1080p, and 720p signal), can be connected. The analog signal inputs are recognized automatically and can be mixed randomly.

If the configured encoding resolution conflicts with the resolution of the front-end camera, the encoding parameters will adjust automatically to meet the front-end camera (e.g., if the resolution of the front-end camera is 720p, then the encoding resolution of the main stream will adjust to 720p automatically).

---

960 × 1080 (1080p Lite) resolution is available when the 1080p Lite is enabled in the Record > Advanced Settings interface.

7. Bitrate Type: Set the bitrate type to be Variable or Constant.
8. Video Quality: Set the video quality of recording, with 6 levels configurable.  
**NOTE:** The Stream Type, Resolution, Bitrate Type, and Video Quality are not configurable for the Main Stream (Event) of the IP Camera.
9. Frame Rate: Set the frame rate of recording.
10. Max. Bitrate Mode: Set the mode to General or Custom.
11. Max Bitrate (Kbps): Select or customize the maximum bit rate for recording.
12. Max. Bitrate Range Recommended: A recommended max. bit rate range is provided for reference.
13. Max. Average Bitrate (Kbps): Set the max. average bit rate which refers to the average amount of data transferred per unit of time.  
**NOTE:** When the connected IP camera does not support H.265, only H.264 can be selected for the video encoding.
14. Check the Enable H.264+ or Enable H.265+ checkbox to enable this function. Enabling it helps to ensure the high video quality with a lower bitrate.  
**NOTE:** If the connected IP camera supports H.265 and H.265 is enabled, Enable H.265+ is shown on the interface instead of Enable H.264+.  
  
After enabling H.264+ or H.265+, the Bitrate Type, Video Quality, Max. Bitrate Mode, Max. Bitrate (Kbps), and Max. Bitrate Range Recommend are not configurable.  
  
H.264+ or H.265+ are not supported simultaneously with SVC.  
  
For the connected IP camera, H.264+ or H.265+ should be supported by the camera and added to the DVR with the HIKVISION protocol.  
  
Reboot the device to activate the new settings after enabling H.264+ or H.265+.
15. Click More Settings to configure more parameters.



Figure 70, More Settings of Record Parameters

- **Pre-record:** The time you set to record before the scheduled time or event. For example, when an alarm triggered the recording at 10:00, if you set the pre-record time as 5 seconds, the camera records it at 9:59:55.
- **Post-record:** The time you set to record after the event or the scheduled time. For example, when an alarm triggered the recording ends at 11:00, if you set the post-record time as 5 seconds, it records till 11:00:05.
- **Expired Time:** The time for keeping the record files in the HDDs, once exceeded, the files will be deleted. The files will be saved permanently if the value is set as 0. The actual keeping time for the files should be determined by the capacity of the HDDs.
- **Redundant Record:** Saves the record in the redundant HDD.
- **Record Audio:** Enable this feature to record the sound and disable it to record the video without sound.
- **Video Stream:** Main stream, Sub-stream and Dual-stream are selectable for recording. When you select sub-stream, you can record for a longer time with the same storage space.

**NOTE:** The Redundant Record option is available only when the HDD mode is *Group*.

Redundant HDD is required for the redundant record function (network drive).

For network cameras, the Main Stream (Event) parameters are not editable.

16. Click Apply to save the settings.

17. Optionally, click Copy to copy the settings to other analog channels if needed.

**NOTE:** The analog signal inputs can be recognized automatically and mixed randomly. So you can copy the same settings of the selected analog camera to any other analog channel.

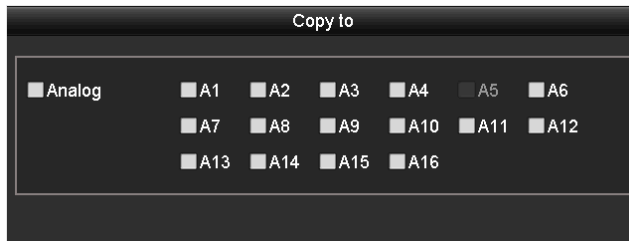

Figure 71, Copy Camera Settings

18. Set encoding parameters for sub-stream.

A. Select the Sub-Stream tab.



Figure 72, Sub-Stream Encoding

B. Select a camera in the camera drop-down list.

C. Configure the parameters.

D. Click Apply to save the settings.

E. (Optional) If the parameters can also be used to other cameras, click Copy to copy the settings to other channels.

**NOTE:** When a 3 MP signal input is connected, the sub-stream frame rate cannot exceed 12 fps.

19. Set parameters for capture.

A. Select the Capture tab.

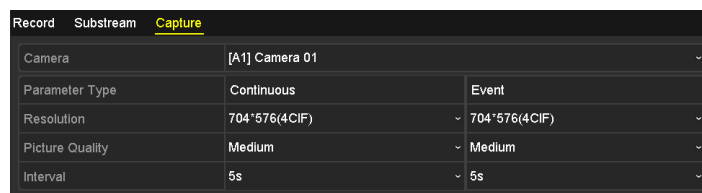

Figure 73, Capture Settings

B. Select a camera in the camera drop-down list.

C. Configure the parameters.

- D. Click Apply to save the settings.
- E. (Optional) If the parameters can also be used to other cameras, click Copy to copy the settings to other channels.

**NOTE:** The interval is the time period between two capturing actions. You can configure all the parameters on this menu on your demand.

## 11.2. Configuring Recording and Capture Schedule

**NOTE:** Continuous, motion, and event triggered recording types are supported.

In this chapter, we take the record schedule procedure as an example, and the same procedure can be applied to configure schedule for both recording and capture. To schedule automatic capture, choose the Capture tab in the Schedule interface.

### 11.2.1. Set the Record Schedule

The camera will automatically start/stop recording according to the configured schedule.

1. Enter the Record Schedule interface, Menu > Record/Capture > Schedule.

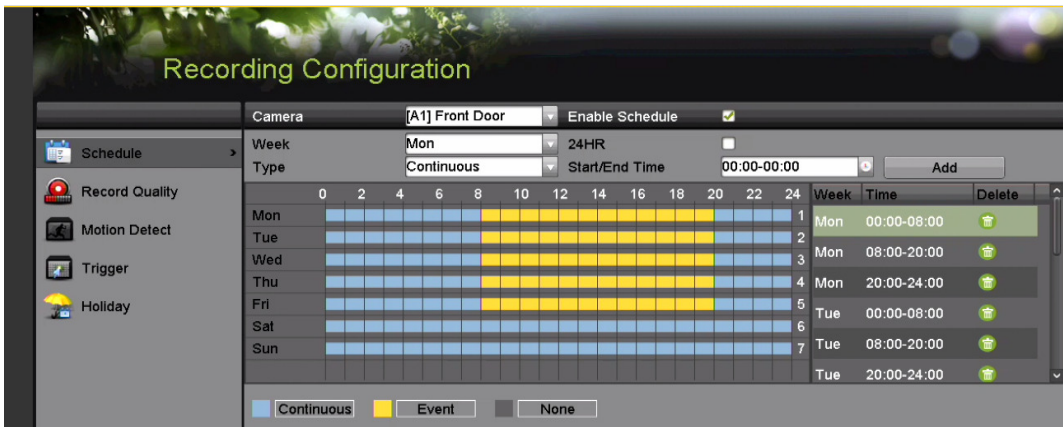

Figure 74, Record Schedule

2. Different recording types are marked in different color icons:
  - Continuous: Scheduled recording
  - Event: Recording triggered by all event triggered alarms. Events include motion, alarm, and VCA events.
  - Motion: Recording triggered by motion detection
  - Alarm: Recording triggered by alarm
  - M/A: Recording triggered by either motion detection or alarm
  - M&A: Recording triggered by motion detection and alarm.
  - None: No recording will take place

3. Choose the camera you want to configure in the Camera drop-down list.
4. Check the Enable Schedule checkbox.
5. Configure the record schedule.
  - A. Click Edit.
  - B. In the message box, you can choose the day to which you want to set schedule.
  - C. To schedule an all-day recording, check the checkbox after the All Day item.

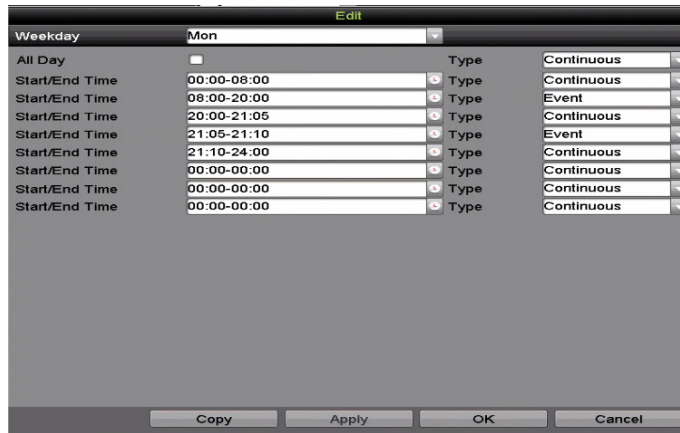

Figure 75, Edit Schedule, All Day

- D. To arrange another schedule, leave the All Day checkbox blank and set the Start/End time. This allows for precise start and end times versus using the drag and drop scheduling.

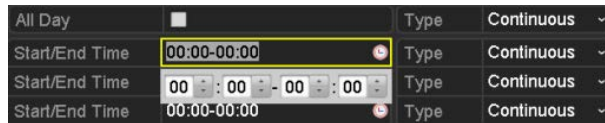

Figure 76, Edit Schedule, Set Time Period

**NOTE:** Up to eight periods can be configured for each day. Time periods cannot overlap.

To enable Event, Motion, Alarm, M | A (motion or alarm), and M & A (motion and alarm) triggered recording, configure the motion detection settings, alarm input settings, or VCA settings as well.

- E. Repeat the above steps to schedule recording for other days in the week. If the schedule can also be set to other days, click Copy.

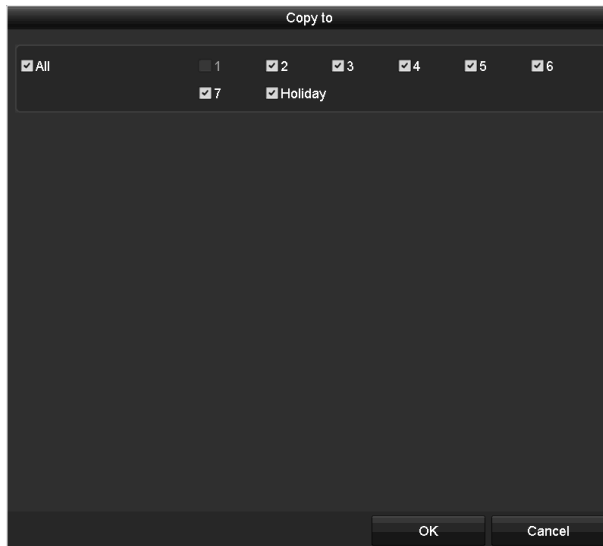

Figure 77, Copy Schedule to Other Days

**NOTE:** The Holiday option is available when you enable holiday schedule in Holiday settings.

6. Click OK to save setting and back to upper level menu.

### 11.2.2. Draw the Schedule

1. Click on the color icon to select a record type in the event list on the right-side of the interface.

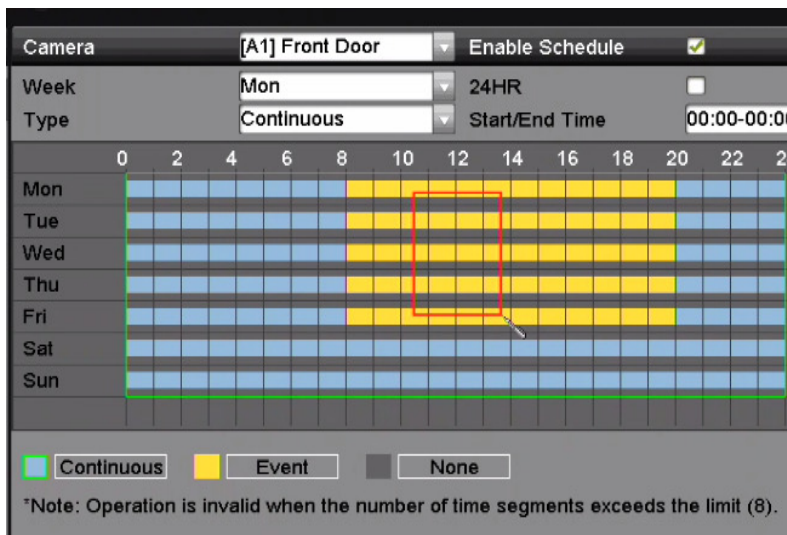

Figure 78, Draw the Recording Schedule



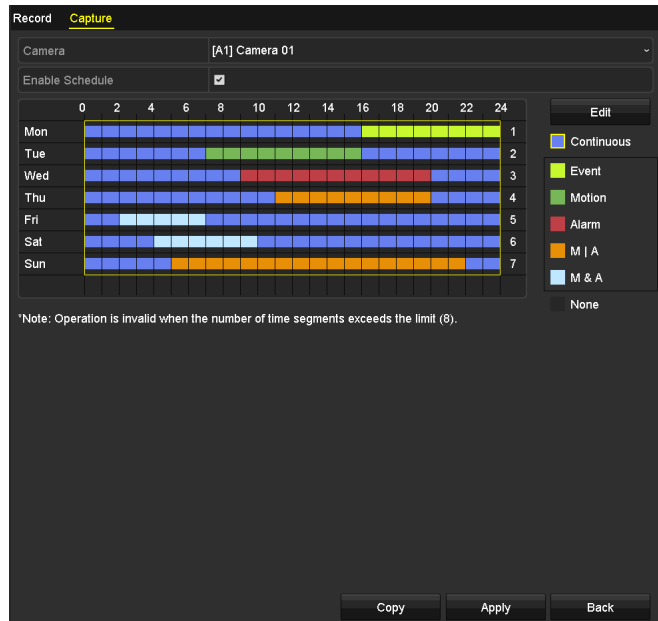

Figure 79, Draw the Capture Schedule

2. Click and drag the mouse on the schedule.
3. Click on any area except the schedule table to finish and exit the drawing.
4. Repeat steps to set schedule for other channels. If the settings can also be used for other channels, click Copy, and then choose the channel you want to copy to.
5. Click Apply in the Record Schedule interface to save the settings.

### 11.3. Configuring Motion Detection Recording and Capture

Set the motion detection parameters. In Live View mode, once a motion detection event takes place, the DVR will analyze it and perform actions to handle it. Enabling motion detection can trigger certain channels to start recording or trigger full screen monitoring, audio warning, notify the surveillance center, send e-mail, etc.

1. Enter the Motion Detection interface, Menu > Camera > Motion.

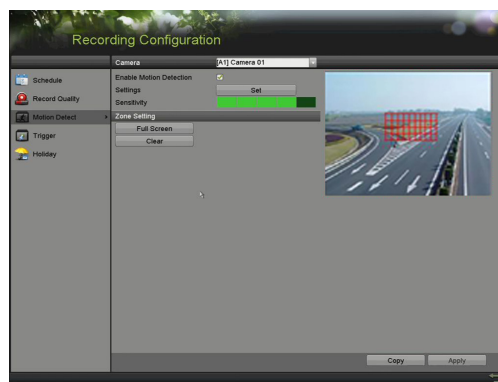

Figure 80, Motion Detection

2. Configure Motion Detection:
  - A. Choose camera you want to configure.

- B. Check the Enable Motion Detection checkbox.
- C. Drag and draw the area for motion detection by mouse. If you want to set the motion detection for all the area in the field of view, click Full Screen. To clear the motion detection area, click Clear.

**NOTE:** Areas that detect active motion turn solid red.

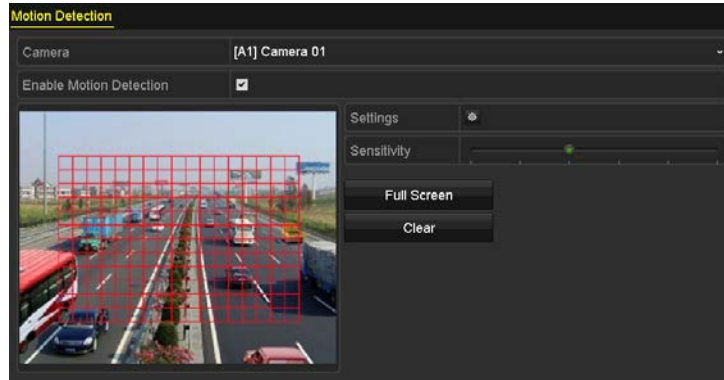

Figure 81, Motion Detection, Mask

- D. Click Set to display the Motion Detection sub menu.

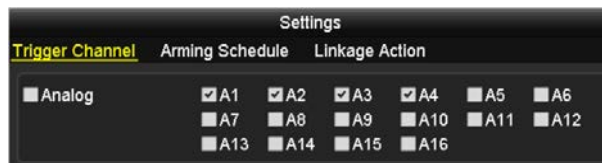

Figure 82, Motion Detection Settings

- E. Select the channels which you want the motion detection event to trigger recording.
- F. Click Apply to save the settings.
- G. Click OK to back to the upper level menu.
- H. Exit the Motion Detection menu.

- 3. Configure the Schedule, choosing Motion as the record type.

## 11.4. Configuring Alarm Triggered Recording

Follow the procedure to configure alarm triggered recording.

- 1. Enter the Alarm Setting interface, Menu > Recording Configuration > Trigger.



Figure 83, Alarm Settings

2. Click the Alarm Input tab.



Figure 84, Alarm Settings, Alarm Input

3. Select Alarm Input number and configure alarm parameters.
4. Choose N.O. (normally open) or N.C. (normally closed) for alarm type.
5. Check the Setting checkbox.
6. Click the Set button.

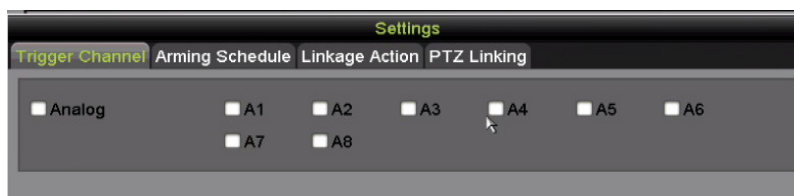

Figure 85, Alarm Handling

7. Choose the alarm triggered recording channel.
8. Check the checkbox  to select channel.
9. Click Apply to save settings.

10. Click OK to back to the upper level menu.
11. Repeat the steps to configure other alarm input parameters.
12. If the setting can also be applied to other alarm inputs, click Copy and choose the alarm input number.

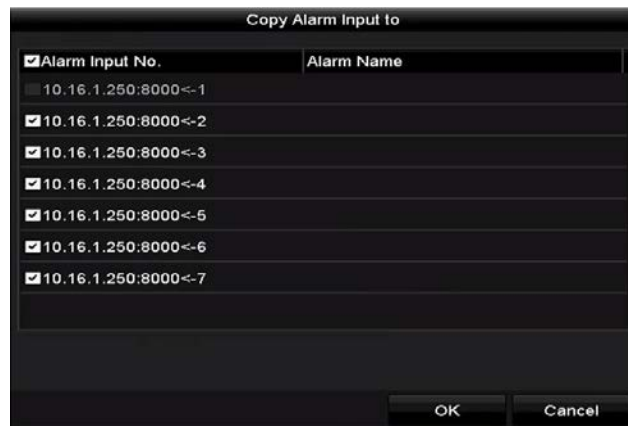

Figure 86, Copy Alarm Input

13. Configure the Recording Schedule. Refer to Configuring Recording and Capture Schedule and choose Alarm as the record type.

## 11.5. Configuring Event Recording

Event triggered recording can be configured through the menu, including 1-ch VCA (line crossing detection and intrusion detection). Channels with audio supports audio exception detection.

1. Enter the VCA settings interface and select a camera for the VCA settings, Menu > Camera > VCA.

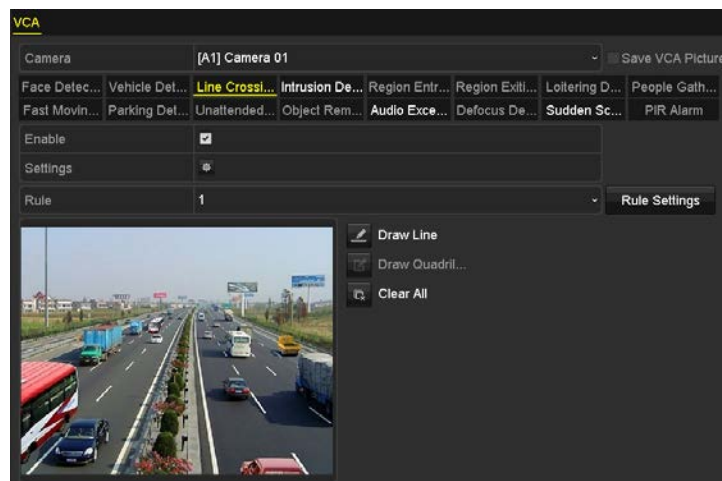



Figure 87, VCA Settings

2. Configure the detection rules for VCA events.
3. Click the icon  to configure the alarm linkage actions for the VCA events.
4. Select Trigger Channel tab and select one or more channels which will start to record when VCA alarm is triggered.
5. Click Apply to save the settings.

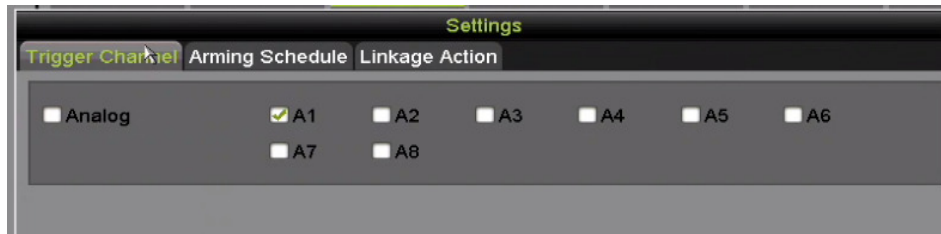

Figure 88, Set Trigger Camera of VCA Alarm

**NOTE:** The PTZ Linking function is available only for the VCA settings of IP cameras.

6. Enter Record Schedule Settings interface (Menu > Record > Schedule > Record Schedule), and set Event as the record type.

## 11.6. Configuring Manual Recording and Continuous Capture

Follow the steps to set parameters for the manual recording and continuous capture. Using manual recording and continuous capture, you need to manually cancel the recording. The manual recording is prior to scheduled recording.

1. Enter the Manual Record interface, Menu > Manual.

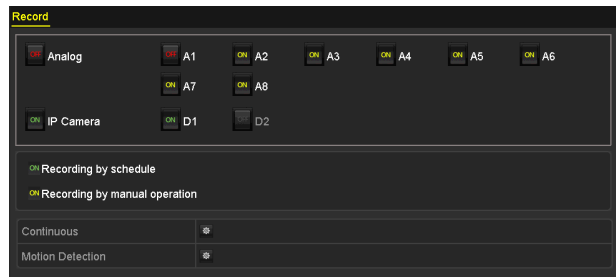

Figure 89, Manual Record

2. Enable manual record.
3. Click the status icon **OFF** before camera number to change it to **ON** or click the status icon **OFF** of Analog to enable manual record of all channels.
4. To disable manual record, click the status icon **ON** to change it to **OFF**, or click the Analog status icon **ON** to disable manual record of all channels.

**NOTE:** After rebooting, all enabled manual records are canceled.

## 11.7. Configuring Holiday Recording

Follow the steps to configure the record schedule on holiday for that year. You may want to have different plan for recording on holiday.

1. Enter the Record setting interface, Menu > Record.
2. Choose Holiday on the left bar.

No.	Holiday Name	Status	Start Date	End Date	Edit
1	Holiday1	Enabled	1.Jan	1.Jan	
2	Holiday2	Disabled	1.Jan	1.Jan	
3	Holiday3	Disabled	1.Jan	1.Jan	
4	Holiday4	Disabled	1.Jan	1.Jan	
5	Holiday5	Disabled	1.Jan	1.Jan	
6	Holiday6	Disabled	1.Jan	1.Jan	
7	Holiday7	Disabled	1.Jan	1.Jan	
8	Holiday8	Disabled	1.Jan	1.Jan	
9	Holiday9	Disabled	1.Jan	1.Jan	
10	Holiday10	Disabled	1.Jan	1.Jan	
11	Holiday11	Disabled	1.Jan	1.Jan	
12	Holiday12	Disabled	1.Jan	1.Jan	

Figure 90, Holiday Settings

3. Enable Edit Holiday schedule.
4. Click to enter the Edit interface.

**Edit**

Holiday Name	<input type="text" value="Holiday5"/>
Enable	<input type="checkbox"/>
Mode	<input type="text" value="By Month"/>
Start Date	<input type="text" value="Jan"/> <input type="text" value="1"/>
End Date	<input type="text" value="Jan"/> <input type="text" value="1"/>

Figure 91, Edit Holiday Settings

5. Check the checkbox of Enable.
6. Select Mode from the drop-down list.

**NOTE:** There are three holiday schedule date formats: By Month, By Week, and By Date are selectable.

7. Set the start and end date.
8. Click Apply to save settings.
9. Click OK to exit the Edit interface.
10. Configure the record schedule. Refer to Configuring Recording Schedule. You may choose Holiday in the Schedule drop-down list, or you can draw the schedule on the Holiday timeline.

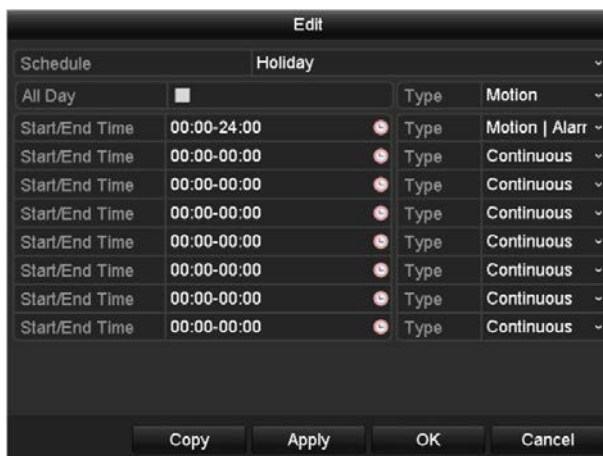

Figure 92, Edit Schedule, Holiday

**NOTE:** Up to eight periods can be configured for each day. Time periods cannot overlap each other.

In the channel timetable, both holiday schedule and normal day schedule are displayed.

Repeat the above steps to set Holiday schedule for other channels. If the holiday schedule can also be used to other channels, click Copy and choose the channel you want to apply the settings.

## 11.8. Configuring HDD Group

You can group the HDDs and save the record files in a certain HDD group.

1. Enter HDD setting interface, Menu > HDD > Advanced.
2. Select Storage Mode tab.
3. Check whether the storage mode of the HDD is Group. If not, set it to Group.
4. Select General in the left bar.
5. Click  to enter editing interface.
6. Configure HDD group.
  - A. Choose a group number for the HDD group.
  - B. Click Apply to save your settings.
  - C. Click OK to back to the upper level menu.
  - D. Repeat the above steps to configure more HDD groups.
7. Choose the Channels which you want to save the record files in the HDD group.
  - A. Enter Storage Mode interface, Menu > HDD > Advanced > Storage Mode.



Figure 93, HDD Advanced

- B. Choose Group number in the dropdown list of Record on HDD Group
- C. Check the channels you want to save in this group.
- D. Click Apply to save settings.

**NOTE:** After you have configured the HDD groups, configure the recording settings.

## 11.9. Files Protection

You can lock the recorded files or set the HDD property to Read-only to protect the record files from being overwritten.

### 11.9.1. Protect File by Locking the Record Files

1. Enter the Export Settings interface, Menu > Export.

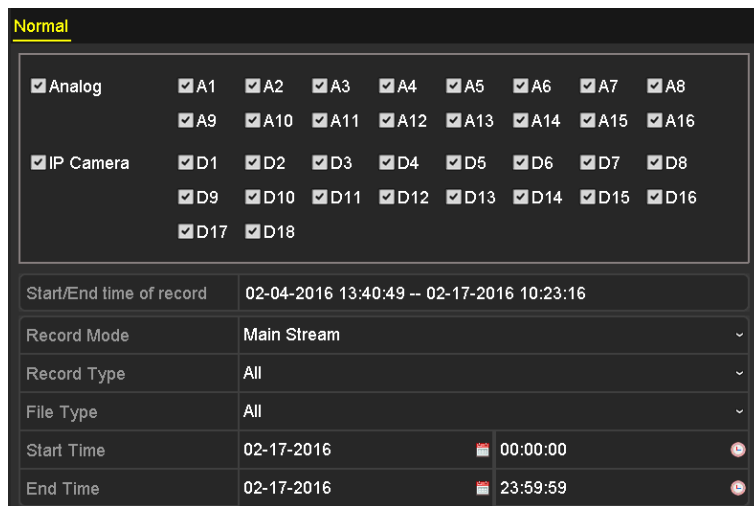

Figure 94, Export

2. Select the channels you want to investigate by checking the checkboxes.
3. Configure the record mode, record type, file type, start time, and end time.
4. Click Search to show the results.



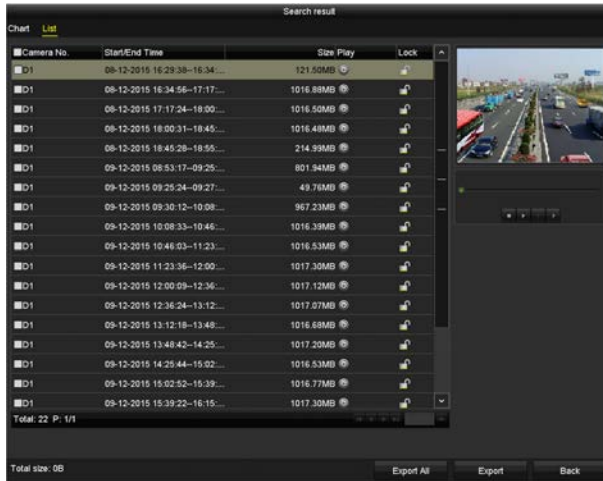





Figure 95, Export, Search Result

- Find the record files you want to protect, and then click the  icon which will turn to , indicating that the file is locked.

**NOTE:** Record files of which the recording is not completed cannot be locked.

- Click  to change it to  to unlock the file and the file is not protected.

### 11.9.2. Protect File by Setting HDD Property to Read-Only

- Enter the HDD setting interface, Menu> HDD.
- Set the HDD storage mode to Group.

Label	Capacity	Status	Property	Type	Free Space	Group	Edit	Delete
1	931.51GB	Normal	R/W	Local	865GB	1		-
3	931.51GB	Normal	R/W	Local	931GB	1		-

Figure 96, HDD General

- Click  to edit the HDD you want to protect.

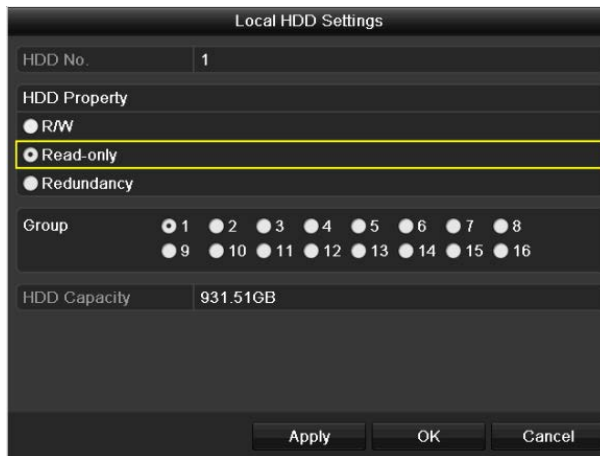

Figure 97, HDD General, Editing

- Set the HDD to Read-only.
- Click OK to save settings and go back to the upper level menu.

**NOTE:** You cannot save files to a Read-Only HDD. To save files to the HDD, change property to R/W.

If there is only one HDD and it is set to Read-Only, the DVR cannot record any files. Only Live View mode is available.

If you set the HDD to Read-Only when the DVR is saving files to it, the file will be saved in the next R/W HDD. If there is only one HDD, the recording will be stopped.

## 12. One-Key H.264+ Enable/Disable

### 12.1. One-Key H.264+ Enabling for All Cameras

1. Enter the Record menu, Menu > Record.
2. Click Advanced to enter the Advanced Settings interface.



Figure 98, Record Information

3. Click Enable to enable H.264+ for all cameras and the following attention box pops up.

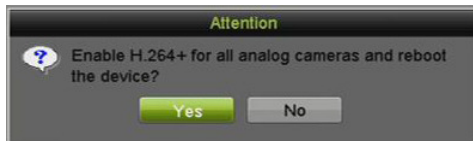

Figure 99, Attention Box

4. Click Yes to enable the function and reboot the device to have new settings taken effect.

**NOTE:** If H.264+ is already enabled for all analog cameras, when you click the Enable button the following attention box pops up to remind you that H.264+ is already enabled.

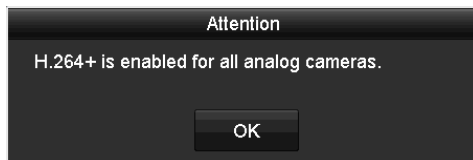

Figure 100, Attention Box

### 12.2. One-Key H.264+ Disabling for All Cameras

1. Enter the Record menu, Menu > Record.
2. Click Advanced to enter the advanced interface.

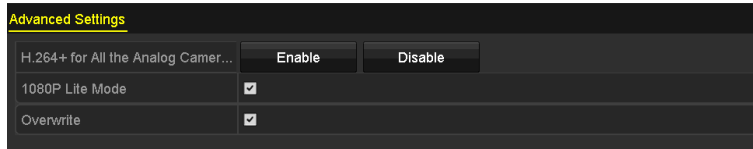

Figure 101, Advanced Settings

3. Click Disable to disable H.264+ for all the analog cameras and the following attention box pops up.



Figure 102, Attention Box

4. Click Yes to enable the function and reboot the device to have new settings taken effect.

**NOTE:** If H.264+ is already disabled for all analog cameras, when you click the Disable button, the following attention box pops up to remind you that H.264+ is already disabled.

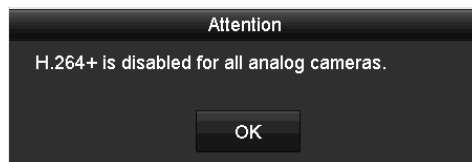

Figure 103, Attention Box

## 13. Playback

### 13.1. Playing Back Record Files

#### 13.1.1. Instant Playback by Channel

Play back the recorded video files of a specific channel in the live view mode. Channel switch is supported.

1. Choose a channel in live view mode and click the  button in the quick setting toolbar.

**NOTE:** In instant playback mode, only files recorded during the last five minutes on this channel will be played back.



Figure 104, Instant Playback Interface

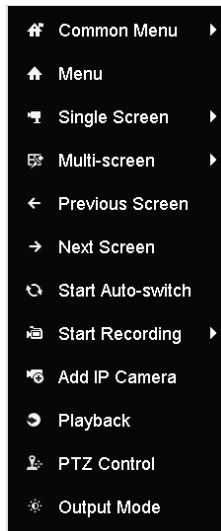

Figure 105, Right-Click Menu Under Live View



### 13.1.2. Play Back by Time

Play back video files recorded in specified time duration. Multi-channel simultaneous playback and channel switch are supported.

1. Enter Playback interface, Menu > Playback.
2. Check the checkbox of channel(s) in the channel list, then double-click to select a date on the calendar.



Figure 106, Playback Calendar

**NOTE:** If there are record files for that camera in that day, in the calendar, the icon for that day is displayed as . Otherwise it is displayed as .

## 13.2. Playback Interface

You can select the main stream or sub stream from the drop-down list for playback.

You can also use the toolbar in the bottom part of Playback interface to control playing progress, as shown in the following figure.



Figure 107, Playback Interface

1. Select the channel(s) if you want to switch playback to another channel or execute simultaneous playback of multiple channels.



Figure 108, Playback Toolbar

Button	Operation	Button	Operation	Button	Operation
	Audio on/Mute		Start/Stop clipping		Lock File
	Add default tag		Add customized tag		File management for video clips, locked files and tags
	Reverse play/Pause		Stop		Digital Zoom
	30s forward		30s reverse		Pause/Play
	Fast forward		Previous day		Slow forward
	Full Screen		Exit		Next day
	Save the clips		Process bar		Scaling up/down the time line

**NOTE:** The **01-01-2015 00:00:23 – 14-07-2015 16:10:27** indicates the start time and end time of the files.

represents normal recording (manual or schedule)

represents event recording (motion, alarm, motion | alarm, motion & alarm, VCA)

Playback progress bar: use the mouse to click any point of the progress bar to locate special frames

### 13.3. Playing Back by Event Search

Play back record files on one or several channels searched out by restricting event type (motion detection, alarm input or VCA). Channel switch is supported.

1. Enter the Playback interface, Menu > Playback.
2. Click and select to enter the Event Playback interface.
3. Select Alarm Input, Motion, VCA as the event type, and specify the start time and end time for search.

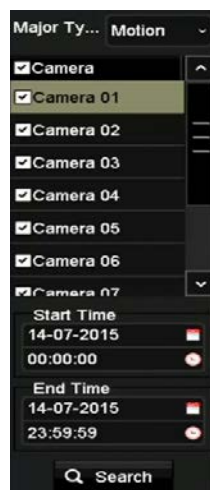



Figure 109, Video Search by Motion Detection

4. Click Search, and the record files matching the search conditions will be displayed on a list.
5. Select and click button to play back the record files.



**NOTE:** Click Back button to return to the search interface.

If there is only one channel triggered, clicking  button takes you to Full-screen Playback interface of this channel.

If several channels are triggered, clicking  button takes you to the Synchronous Playback interface. Check  checkbox to select one channel for playback or select multiple channels for synchronous playback.

The maximum number of channels for synchronous playback varies by model.



Figure 110, Select Channels for Synchronous Playback



6. On the Event Playback interface, you can select the main stream or sub-stream from the drop-down list for playback.
7. The toolbar in the bottom part of Playback interface can be used to control playing process.



Figure 111, Interface of Playback by Event

- Pre-play and post-play can be configured for playback of event triggered record files.

- Pre-play: The time set to play back before the event. For example, if an alarm triggers the recording at 10:00, if the pre-play time is set to 5 seconds, the video will play back from 9:59:55.
- Post-play: The time to play back after the event. For example, if an alarm triggers the recording to end at 11:00, if the post-play time is set as 5 seconds, the video will play back till 11:00:05.

8. Click the  or  button to select the previous or next event.

## 13.4. Playing Back by Tag



Video tags allow you to record related information such as people and locations at a certain time point during playback. You can also use video tag(s) to search for record files and position time points.

### 13.4.1. Before Playing Back by Tag

1. Enter the Playback interface, Menu > Playback.
2. Search and play back the record file(s).



Figure 112, Interface of Playback by Time

3. Click  button to add default tag.
4. Click  button to add customized tag and input tag name.

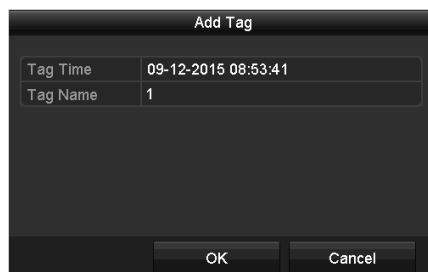

Figure 113, Add Tag

**NOTE:** Maximum of 64 tags can be added to a single video file.



5. Tag management. Click  button to check, edit, and delete tag(s).



Figure 114, Tag Management Interface

6. Select Tag from the drop-down list in the Playback interface.
7. Choose channels, edit start time and end time, and then click Search to enter Search Result interface.

**NOTE:** Enter keyword in the textbox  to search the tag on your command.



Figure 115, Video Search by Tag

8. Click  button to playback the file.
9. Click the Back button to return to the search interface.

**NOTE:** Pre-play and post-play can be configured.

Click  or  button to select the previous or next tag.

## 13.5. Playing Back by System Logs

Play back record file(s) associated with channels after searching system logs.

1. Enter Log Information interface, Menu > Maintenance > Log Information.

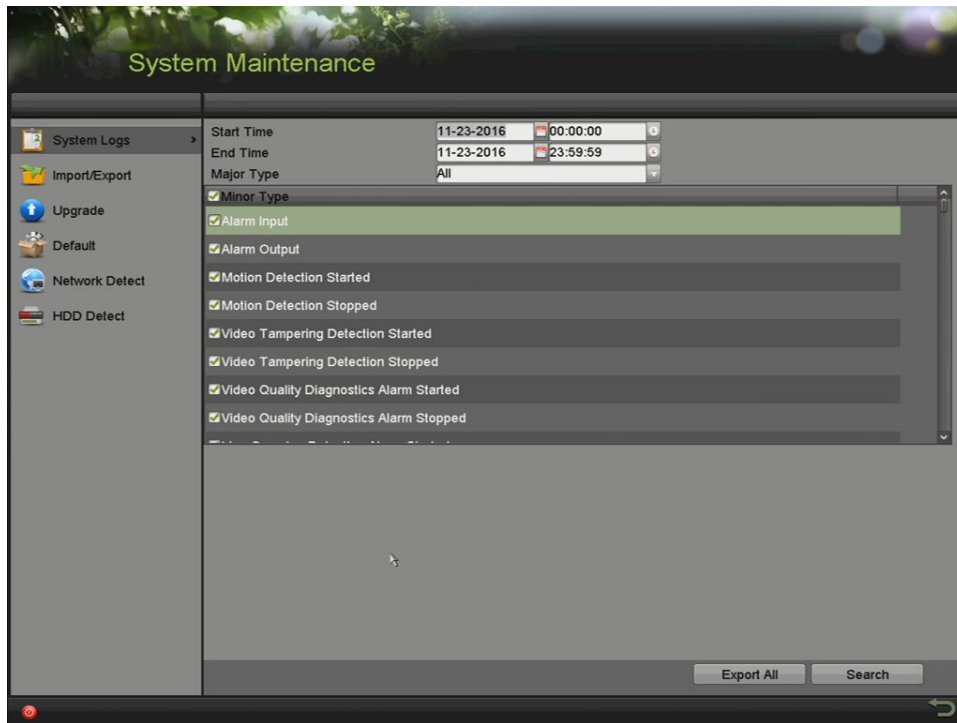

Figure 116, System Log Search Interface

2. Click Log Search tab to enter System Log Search interface.
3. Set search time and type and click Search button.

No.	Major Type	Time	Minor Type	Parameter	Play	Details
1	Information	10-07-2015 09:53:59	Local HDD Infor...	N/A	—	✓
2	Operation	10-07-2015 09:53:59	Power On	N/A	—	✓
3	Information	10-07-2015 09:54:05	Start Recording	N/A	⏮	✓
4	Operation	10-07-2015 09:54:08	Local Operation:...	N/A	—	✓
5	Information	10-07-2015 09:54:25	HDD S.M.A.R.T.	N/A	—	✓
6	Information	10-07-2015 09:54:32	Start Recording	N/A	⏮	✓
7	Operation	10-07-2015 09:54:32	Local Operation:...	N/A	⏮	✓
8	Operation	10-07-2015 09:54:32	Local Operation:...	N/A	⏮	✓
9	Exception	10-07-2015 09:55:32	IP Camera Disco...	N/A	⏮	✓
10	Information	10-07-2015 10:04:09	System Running...	N/A	—	✓

Total: 1690 P: 1/17

Figure 117, Result of System Log Search

4. Choose a log with record file and click  button to enter Playback interface.

**NOTE:** If there is no record file at the timepoint of the log, a “No result found” message will pop up.

5. Playback management. The toolbar in the bottom of the Playback interface can be used to control the playing process.



Figure 118, Interface of Playback by Log

### 13.6. Playing Back by Sub-Periods

The video files can be played in multiple sub-periods simultaneously on the screens.

1. Enter Playback interface, Menu > Playback.
2. Select Sub-periods from the drop-down list in the upper-left corner of the page to enter the Sub-periods Playback interface.
3. Select a date and start playing the video file.
4. Select the Split-Screen Number from the drop-down list. Up to 16 screens are configurable.

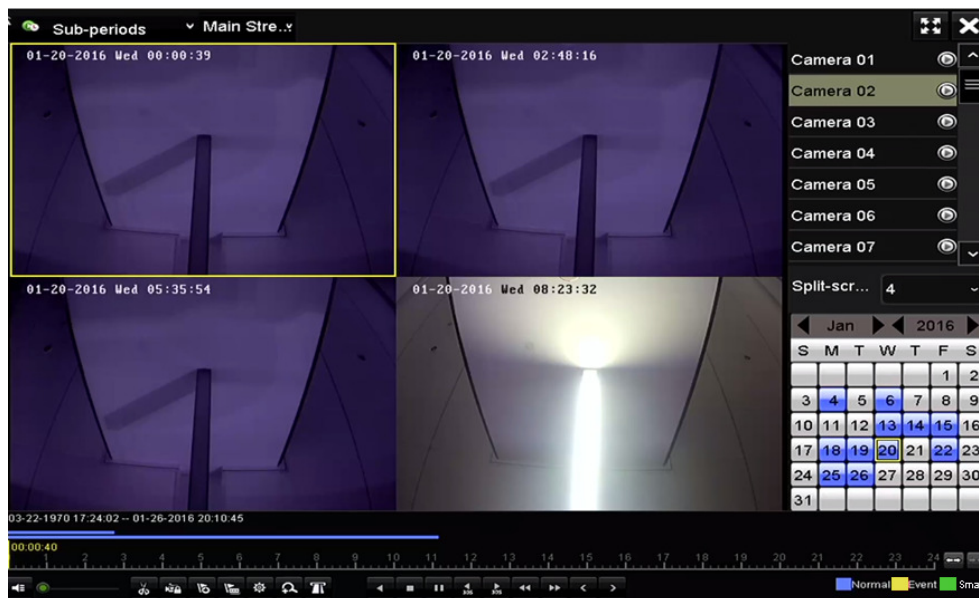

Figure 119, Interface of Sub-periods Playback

**NOTE:** According to the defined number of split-screens, the video files on the selected date can be divided into average segments for playback. E.g., if there are video files existing between 16:00 and 22:00, and the 6-screen display mode is selected, then it can play the video files for 1 hour on each screen simultaneously.

## 13.7. Playing Back External Files

Perform the following steps to look up and play back files in the external devices.



1. Enter the Playback interface, Menu > Playback.
2. Select the External File in the drop-down list on the top-left side. The files are listed in the right-side list.
3. You can click the  button to refresh the file list.
4. Select and click the  button to play back it.





Figure 120, Interface of External File Playback

## 13.8. Auxiliary Playback Functions

### 13.8.1. Playing Back Frame-by-Frame

Play video files frame-by-frame to check video image details when abnormal events happen.

1. Go to Playback interface and click button  until the speed changes to *Single* frame.
2. One click on the playback screen represents playback or adverse playback of one frame. You can use button  in toolbar to stop the playing.

### 13.8.2. Digital Zoom

1. Click the  button on the playback control bar to enter the Digital Zoom interface.
2. Use the mouse to draw a red rectangle and the image within it will be enlarged up to 16 times.





Figure 121, Draw Area for Digital Zoom

3. Right-click the image to exit the digital zoom interface.

### 13.8.3. Reverse Playback of Multi-Channels

You can play back record files of multi-channel reversely. Up to 16 channels of simultaneous reverse playback is supported.

1. Enter the Playback interface, Menu > Playback.
2. Check more than one checkboxes to select multiple channels and click to select a date on the calendar.



Figure 122, 4-ch Synchronous Playback Interface

3. Click  to play back the record files reversely.

# 14. Backing Up Record Files

## 14.1. Before Starting

Insert the backup device(s) into the device.

## 14.2. Backing Up by Normal Video/Picture Search

Record files can be backed up to various devices such as USB devices (USB flash drives, USB HDDs, USB writer), SATA writer, and e-SATA HDD.

### 14.2.1. Back Up Using USB Flash Drives and USB HDDs

1. Enter Export interface, Menu > Export > Normal/Picture.
2. Select the cameras to search.
3. Select Main/Sub Stream and Recording Mode.

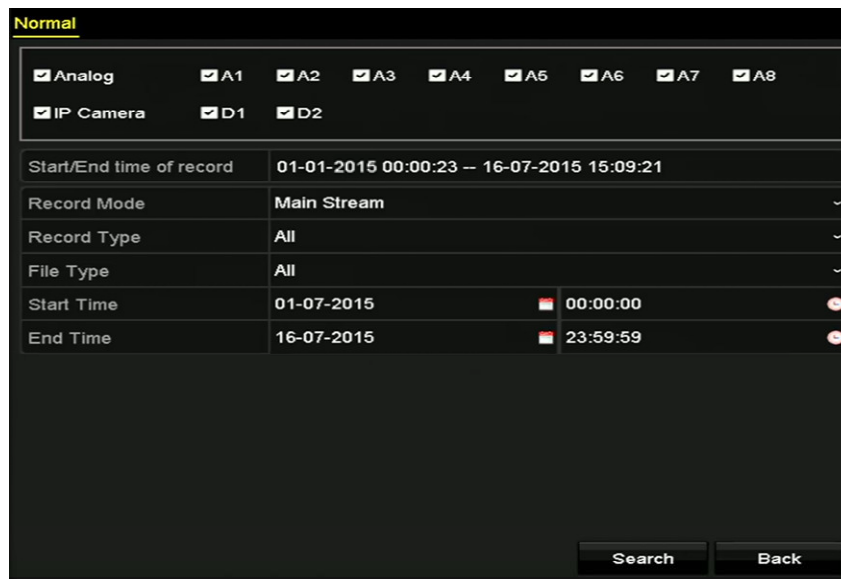



Figure 123, Normal Video Search for Backup

4. The matched video files are displayed in Chart or List display mode.
5. Click  to play the record file if you want to check it.
6. Check the checkbox before the video files you want to back up.

**NOTE:** The size of the currently selected files is displayed in the lower-left corner of the window.



Figure 124, Result of Normal Video Search for Backup

7. Select video files from the Chart or List to export, and click the button Export to enter the Export interface.

**NOTE:** You can also click Export All to select all the video files for backup and enter the Export interface.



Figure 125, Export by Normal Video Search Using USB Flash Drive

8. Select the backup device from the drop-down list (you can also select the file format to filter the files existing in the backup device).
9. Select the saving type.
10. Click the Export button on the Export interface to start the backup process. On the pop-up message box, select to export the video files or the player to the backup device. Click OK to confirm.



Figure 126, Select File or Player for Backup

11. A prompt message will pop up after the backup process is complete. Click OK to confirm.

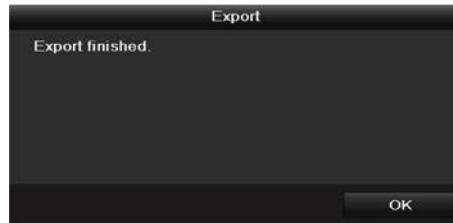

Figure 127, Export Finished

### 14.3. Backing Up by Event Search

Back up event-related record files using USB devices (USB flash drives, USB HDDs, USB writer), SATA writer, or eSATA HDD. Quick Backup and Normal Backup are supported.

1. Enter Export interface, Menu > Export > Event.
2. Select the cameras to search.
3. Select the event type to alarm input, motion, or VCA.

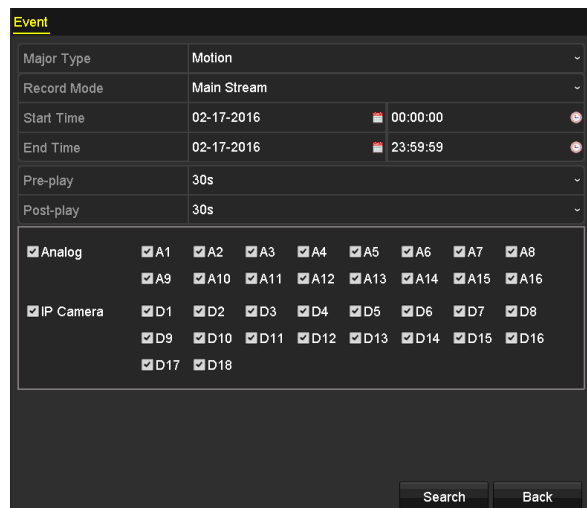

Figure 128, Event Search for Backup

4. Set search condition and click Search button to enter the search result interface. The matched video files are displayed in Chart or List display mode.
5. Select video files from the Chart or List interface to export.



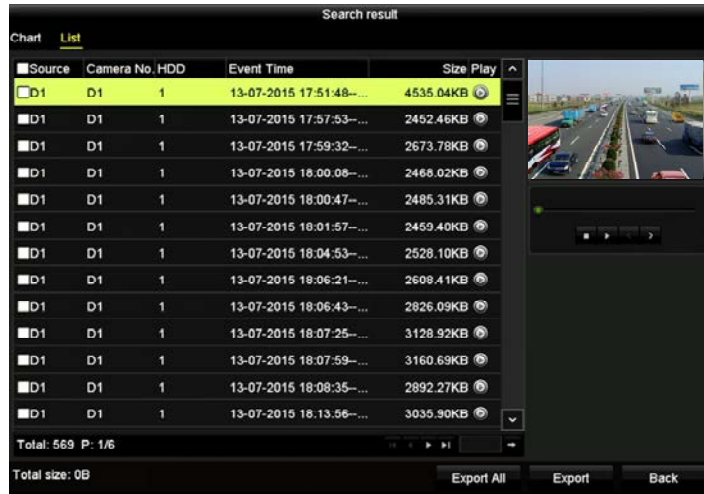





Figure 129, Result of Event Search

6. Export the video files.

## 14.4. Backing Up Video Clips

You may select video clips in playback mode to export directly during Playback, using USB devices (USB flash drives, USB HDDs, USB writer), or SATA writer.

1. Enter Playback interface.
2. During playback, use the  or  buttons in the playback toolbar to start or stop clipping record file(s).
3. Click  to enter the file management interface.

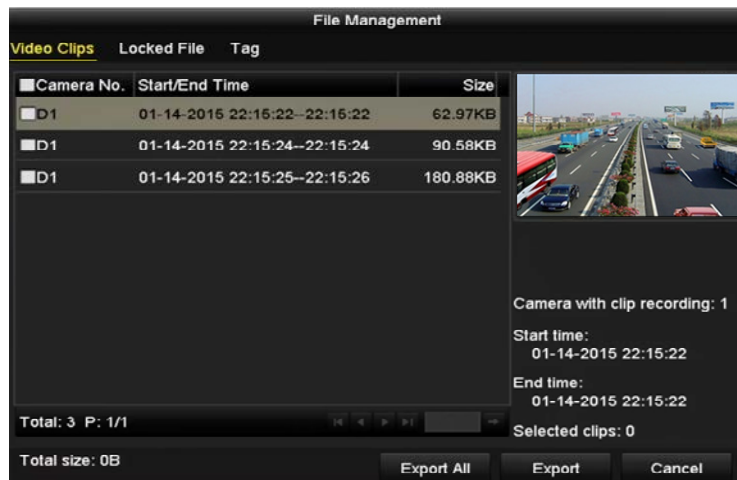

Figure 130, Video Clips Export Interface

4. Export the video clips in playback.

## 14.5. Managing Backup Devices

Manage USB flash drives, USB HDDs, and eSATA HDDs.

1. Enter the Export interface, Backup Device Management.



Figure 131, Storage Device Management

2. Click New Folder button if you want to create a new folder in the backup device.
3. Select a record file or folder in the backup device and click the  button if you want to delete it.
4. Click Erase button if you want to erase the files from a re-writable CD/DVD.
5. Click Format button to format the backup device.

**NOTE:** If the inserted storage device is not recognized, click the Refresh button, reconnect the device, or check for compatibility from vendor.

## 15. Alarm Settings

### 15.1. Setting Motion Detection

1. Enter the Camera Management Motion Detection interface, Menu > Camera > Motion.
2. Choose a camera you want to set up for motion detection.



Figure 132, Motion Detection Setup Interface

3. Set detection area and sensitivity.
4. Check  motion detection checkbox.
5. Use the mouse to draw detection area(s) or click Full Screen to set the area to be the full screen.
6. Drag the sensitivity bar to set sensitivity.
7. Click  to set alarm response actions.

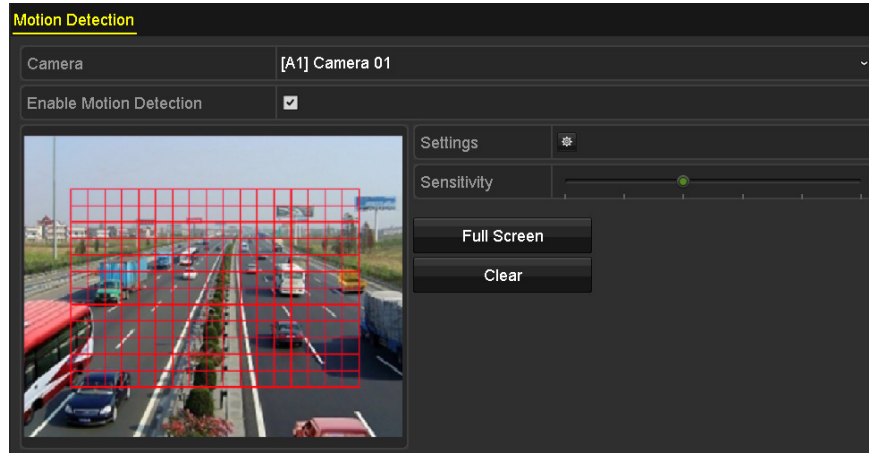

Figure 133, Set Detection Area and Sensitivity

8. Click Trigger Channel tab and select one or more channels that will start to record or become full-screen monitoring when a motion alarm is triggered.

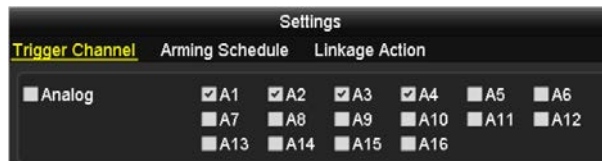

Figure 134, Set Trigger Camera of Motion Detection

9. Select Arming Schedule tab to set the channel's arming schedule.
10. Choose one day of a week, and up to eight time periods can be set within each day. Or, click the Copy button to copy the time period settings to other day(s).

**NOTE:** Time periods must not repeat or overlap.

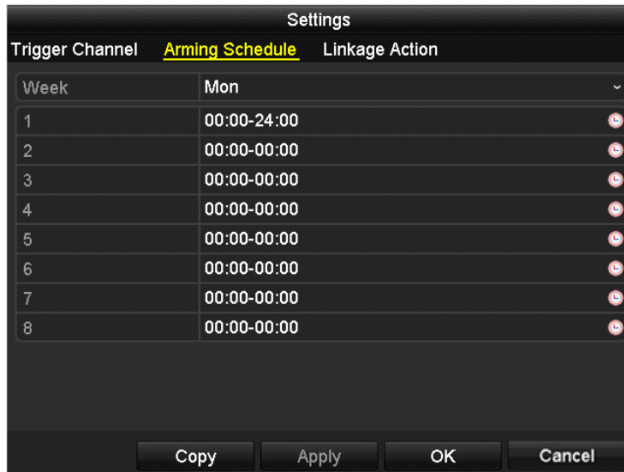

Figure 135, Set Arming Schedule of Motion Detection

11. Click Linkage Action tab to set up alarm response actions of motion alarm.
12. Repeat the above steps to set up arming schedule for other days of the week.
13. Click the OK button to complete the channel's motion detection settings.
14. To set motion detection for another channel, repeat the above steps or just copy above settings to it.

**NOTE:** You are not allowed to copy the "Trigger Channel" action.

## 15.2. Setting Sensor Alarms

Set up handling method of an external sensor alarm.

1. Enter Alarm Settings of System Configuration and select an alarm input, Menu > Record Configuration > Trigger.
2. Select Alarm Input tab to enter Alarm Input Settings interface.

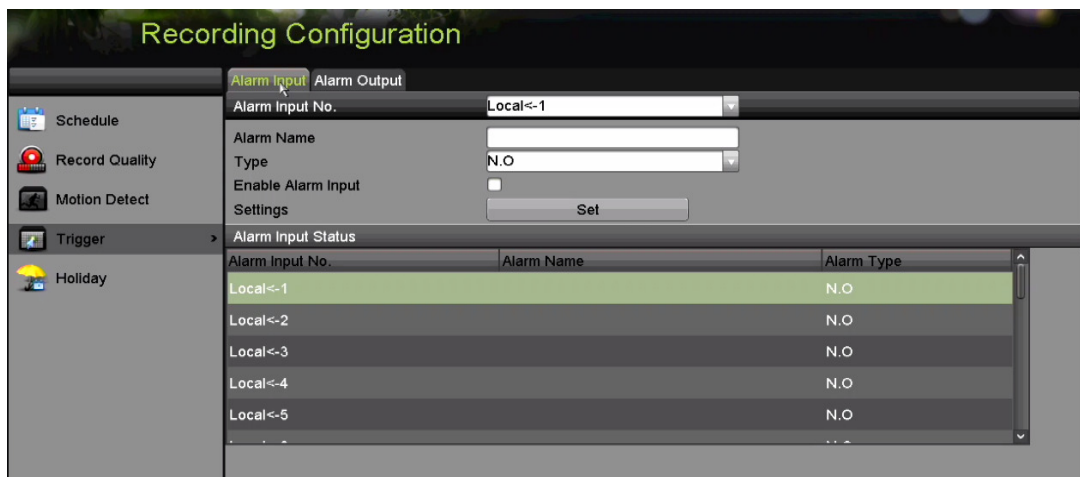

Figure 136, Alarm Status Interface of System Configuration

3. Set the handling method of the selected alarm input.
4. Check the Enable checkbox and click the Set button to set its alarm response actions.

5. Select Trigger Channel tab and select one or more channels that will start to record or become full-screen monitoring when an external alarm input is triggered.
6. Select Arming Schedule tab to set the channel's arming schedule.
7. Choose one day of a week, a maximum of eight time periods can be set within each day.

**NOTE:** Time periods must not repeat or overlap.

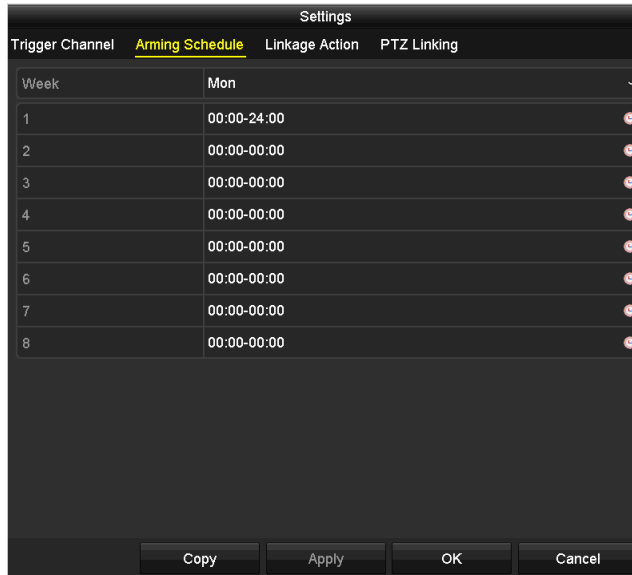

Figure 137, Set Arming Schedule of Alarm Input

8. Select Linkage Action tab to set up alarm response actions of the alarm input.
9. Repeat the above steps to set up arming schedule of other days of a week. You can also use Copy button to copy an arming schedule to other days.
10. If necessary, select PTZ Linking tab and set PTZ linkage of the alarm input.
11. Set PTZ linking parameters and click the OK button to complete the settings of the alarm input.

**NOTE:** Check whether the PTZ or speed dome supports PTZ linkage.

One alarm input can trigger presets, patrols, or patterns of more than one channel. But presets, patrols, and patterns are exclusive.



Figure 138, Set PTZ Linking of Alarm Input

12. To set handling action of another alarm input, repeat the above steps or just copy above settings to it.

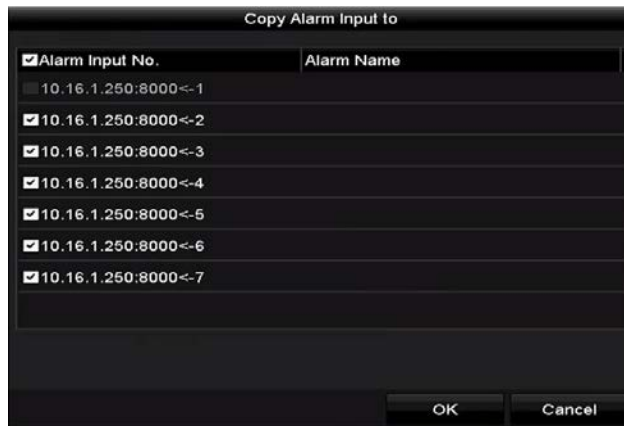

Figure 139, Copy Settings of Alarm Input

### 15.3. Detecting Video Loss

Detect video loss of a channel and take alarm response action(s).

1. Enter Camera Management Video Loss interface, Menu > Camera > Video Loss.
2. Select a channel you want to detect.

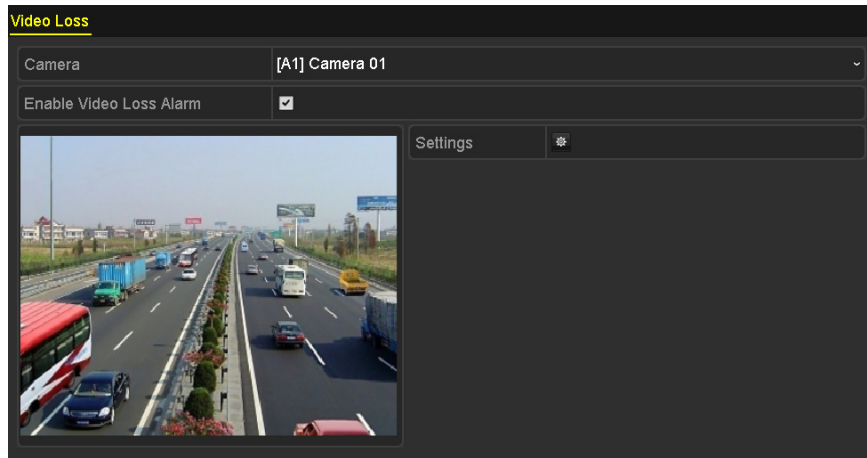

Figure 140, Video Loss Setup Interface

3. Set up handling method for a video loss.
4. Check the Enable Video Loss Alarm checkbox.
5. Click the Set button to set up handling method of video loss.
6. Set arming schedule of the channel.
7. Select Arming Schedule tab to set the channel's arming schedule.
8. Choose one day of a week and up to eight time periods can be set within each day. Or you can click the Copy button to copy the time period settings to other day(s).

**NOTE:** Time periods must not repeat or overlap.

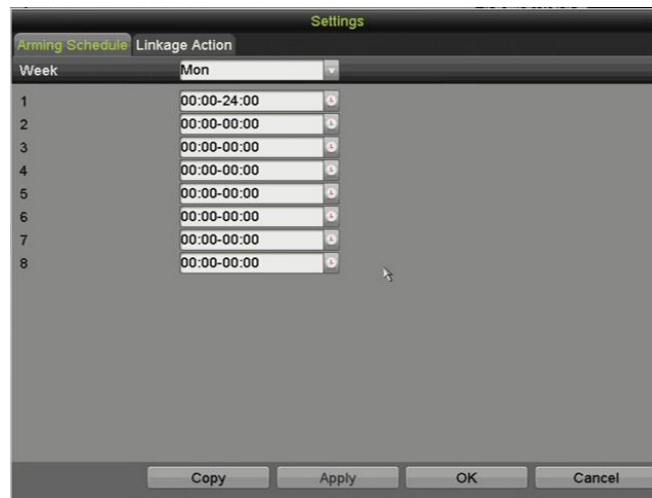

Figure 141, Set Arming Schedule of Video Loss

9. Repeat the above steps to set arming schedule of other days of a week. You can also use Copy button to copy an arming schedule to other days.
10. Select Linkage Action tab to set up alarm response action of video loss.
11. Click the OK button to complete the video loss settings of the channel.
12. Repeat above steps to set other channels, or click the Copy button to copy the settings to them.

## 15.4. Detecting Video Tampering

Trigger alarm when the lens is covered and take alarm response action(s).

1. Enter Camera Management Video Tampering interface, Menu > Camera > Video Tampering Detection.
2. Select a channel on which you want to detect video tampering.

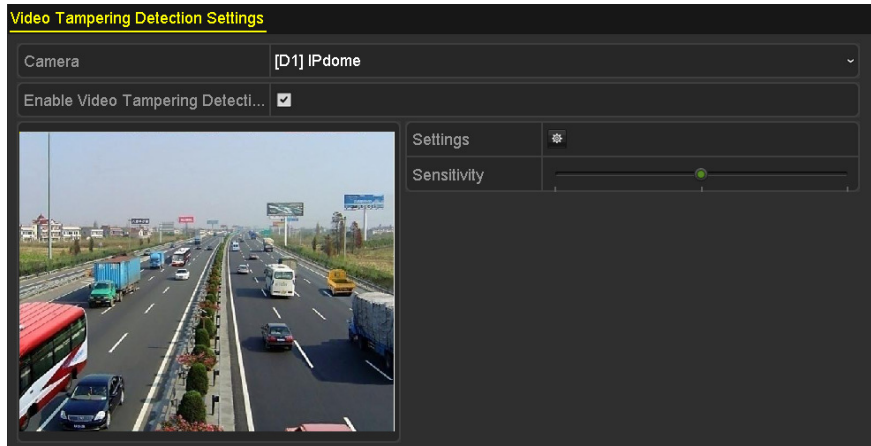

Figure 142, Video Tampering Interface

3. Check the Enable Video Tampering Detection checkbox.
4. Drag the sensitivity bar to choose sensitivity level.
5. Click Set button to set video tampering handling method. Set channel arming schedule and alarm response actions.
6. Click Arming Schedule tab to set the response action arming schedule.
7. Choose one day of a week, and up to eight time periods can be set within each day.

**NOTE:** Time periods must not repeat or overlap.

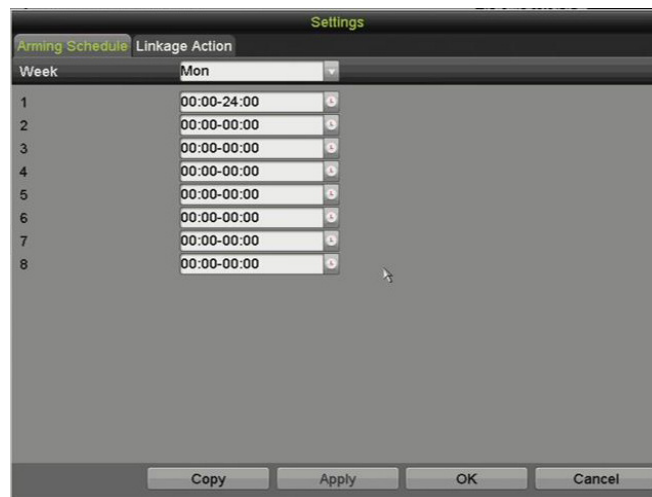

Figure 143, Set Arming Schedule of Video Tampering

8. Select Linkage Action tab to set alarm response actions of video tampering alarm.



9. Repeat the above steps to set arming schedule for other days of the week. You can also use the Copy button to copy an arming schedule to other days.
10. Click the OK button to complete the video tampering settings of the channel.
11. Repeat the above steps to set other channels, or click the Copy button copy the settings to them.
12. Click the Apply button to save and activate the settings.

## 15.5. Setting All-Day Video Quality Diagnostics

Video quality can be diagnosed manually and all-day. Set the diagnosing and linkage action thresholds.

1. Enter Camera Management Video Quality Diagnostics Settings interface, Menu > Camera > Video Quality Diagnostics.
2. Select a channel you want to detect video tampering.

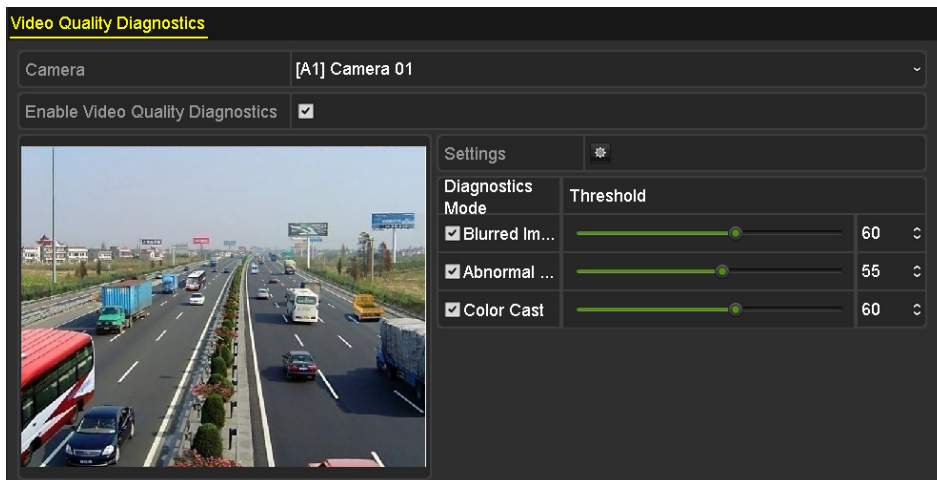



Figure 144, Video Quality Diagnostics Interface

3. Check the Enable Video Quality Diagnostics checkbox.
 

**NOTE:** To enable video quality diagnostics, the function must be supported by the selected camera.
4. Enable and set the diagnostic type threshold: blurred Image, abnormal brightness, and color cast.
5. Check the corresponding checkbox of the diagnostic type, and adjust its threshold by dragging the bar.
 

**NOTE:** The higher the threshold set, the more difficult to detect the exception.
6. Click  to set the handling method of the video quality diagnostics. Set arming schedule and alarm response actions of the channel.
7. Click the Arming Schedule tab to set the arming schedule of response action.
8. Choose one day of a week, and up to eight time periods can be set within each day.

**NOTE:** Time periods must not repeat or overlap.

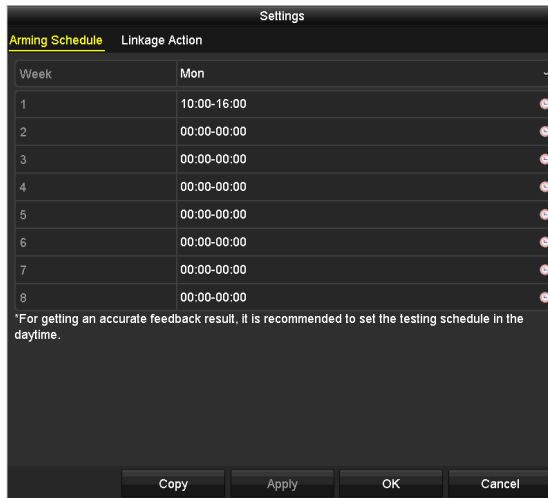

Figure 145, Set Arming Schedule of Video Quality Diagnostics

9. Select Linkage Action tab to set alarm response actions of video quality diagnostics alarm.
10. Repeat the above steps to set arming schedule for other days of the week. You can also use the Copy button to copy an arming schedule to other days.
11. Click the OK button to complete the channel's video quality diagnostics settings.
12. Click the Apply button to save and activate settings.
13. (Optional) copy the same settings to other cameras by clicking the Copy button.

## 15.6. Handling Exceptions

Exception settings refer to the handling method of various exceptions:

- HDD Full: The HDD is full
- HDD Error: Writing HDD error, unformatted HDD, etc.
- Network Disconnected: Disconnected network cable
- IP Conflicted: Duplicated IP address
- Illegal Login: Incorrect user ID or password
- Input/Recording Resolution Mismatch: The input resolution is smaller than the recording resolution
- Record/Capture Exception: No space for saving recorded files or captured pictures

1. Enter Exceptions interface, Menu > Configuration > Exceptions.
2. Handle the various exceptions as appropriate.

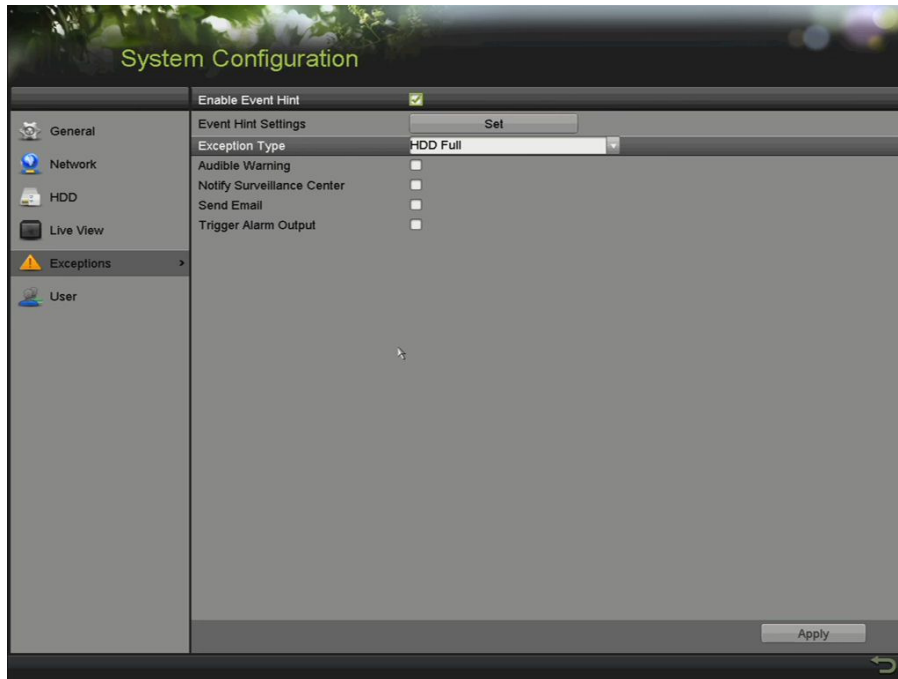



Figure 146, Exception Settings Interface

3. Check the Enable Event Hint checkbox to display the  (Event/Exception icon) when an exceptional event occurs. Click the Set Button to display the detailed event hint.

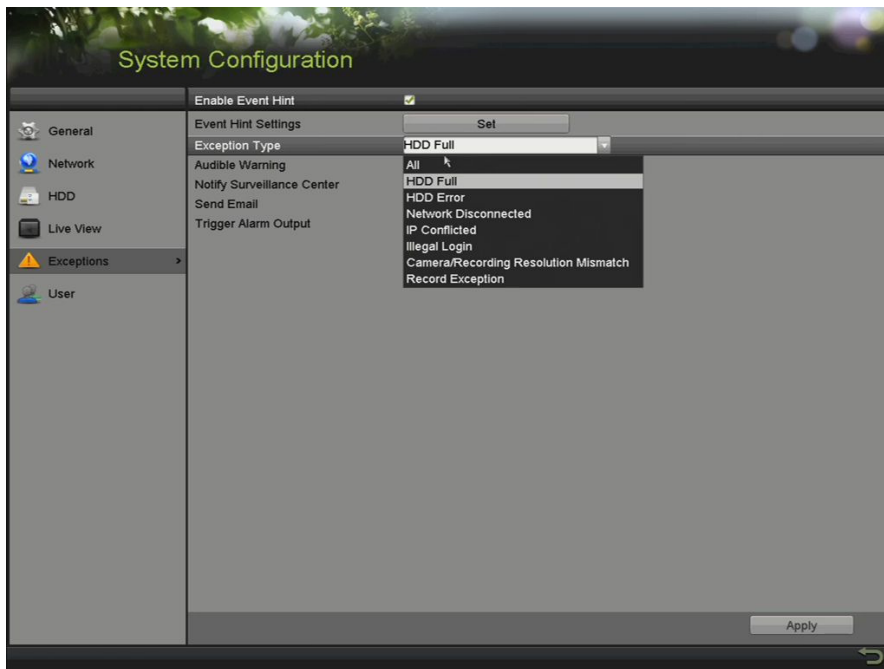



Figure 147, Event Hint Settings

**NOTE:** Click the  icon in the Live View interface to view detailed information of the exceptional event. Click the Set button to display the detailed event hint.

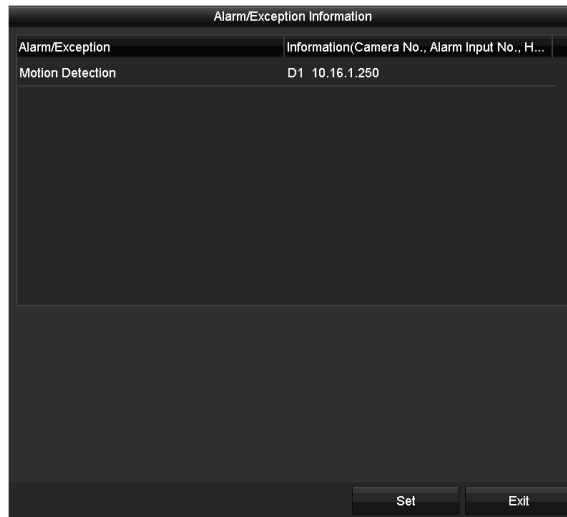

Figure 148, Detailed Event

4. Set the alarm linkage actions.
5. Click Apply to save the settings.

## 15.7. Setting Alarm Response Actions

Alarm response actions will be activated when an alarm or exception occurs, including Full Screen Monitoring, Audible Warning (buzzer), Notify Surveillance Center, Send E-mail, and Trigger Alarm Output.

- **Full Screen Monitoring** – When an alarm is triggered, the local monitor (HDMI or VGA monitor) displays in full screen the video image from the alarming channel configured for full screen monitoring.
- **Dwell Time.** If alarms are triggered simultaneously in several channels, their full-screen images will be switched at an interval of 10 seconds (default dwell time). A different dwell time can be set by going to Menu > Configuration > Live View.
- **Auto Switch.** Auto-switch will terminate once the alarm stops and will return to the Live View interface.
- **Audible Warning** – Triggers an audible beep when an alarm is detected.
- **Notify Surveillance Center** – Sends an exception or alarm signal to remote alarm host when an event occurs. The alarm host refers to the PC installed with Remote Client.

**NOTE:** The alarm signal will be transmitted automatically at detection mode when the remote alarm host is configured.

- **Send E-Mail** – Sends an e-mail with alarm information to a user or users when an alarm is detected.
- **Trigger Alarm Output** – Triggers an alarm output when an alarm is triggered.
  1. Enter Alarm Output interface, Menu > Record Configuration > Trigger > Alarm Output.
  2. Select an alarm output and set alarm name and dwell time.



Figure 149, Alarm Output Settings Interface

**NOTE:** If Manually Clear is selected in the Dwell Time drop-down list, clear it by going to Menu > Record Configuration > Trigger.

3. Click the Set button to set the alarm output arming schedule.
4. Choose one day of a week, and up to eight time periods can be set within each day.

**NOTE:** Time periods must not repeat or overlap.

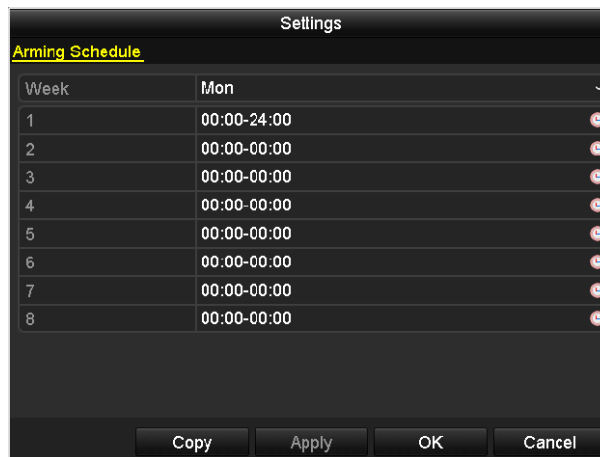

Figure 150, Set Arming Schedule of Alarm Output

5. Repeat the above steps to set arming schedule for other days of a week. You can also click the Copy button to copy an arming schedule to other days.
6. Click the OK button to complete the alarm output arming schedule setting.
7. Click the Apply button to save the settings.

## 16. Network Settings

### 16.1. Configuring General Settings

Network settings must be properly configured before operating the DVR over a network.

1. Enter the Network Settings interface, Menu > Configuration > Network.



Figure 151, Network Settings Interface

**NOTE:** One self-adaptive network interface is provided.

2. Select the General tab.
3. Configure the following parameters: NIC Type, IPv4 Address, IPv4 Gateway, MTU, DNS Server, and Main NIC.

**NOTE:** The valid MTU value is from 500 to 1500.

If a DHCP server is available, check the Enable DHCP checkbox to obtain an IP address and other network settings automatically from that server.

If DHCP is enabled, check Enable DNS DHCP checkbox or uncheck it and edit the Preferred DNS Server and Alternate DNS Server.

4. After having configured the general settings, click the Apply button to save the settings.

## 16.2. Configuring Advanced Settings

### 16.2.1. Configuring PPPoE Settings

The DVR allows access by Point-to-Point Protocol over Ethernet (PPPoE).

1. Enter the Network Settings interface, Menu > Configuration > Network.
2. Select the PPPoE tab to enter the PPPoE Settings interface.

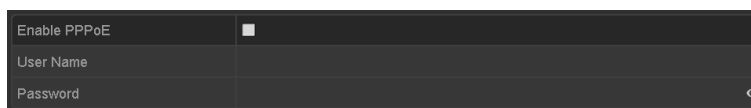

Figure 152, PPPoE Settings Interface

- 
3. Check the Enable PPPoE checkbox to enable this feature.
  4. Enter User Name and Password for PPPoE access.  
**NOTE:** The User Name and Password is assigned by your ISP.
  5. Click the Apply button to save the settings.
  6. After successful settings, the system asks you to reboot the device to enable the new settings, and the PPPoE dial-up is automatically connected after the reboot.
  7. Go to Menu > Maintenance > System Info > Network interface to view the PPPoE connection status.

### 16.2.2. Register a HIK-Connect P2P Cloud Service Account

Use the Hik-Connect mobile app (from iOS App Store or Google Play) to create a Hik-Connect P2P Cloud account to connect Hikvision devices over the Internet.

1. Click on “Register an Account.”
2. Check the Read and Agree checkbox.
3. Register the Account.
  - Using Mobile Phone Number:
    - 1) Click Register by Mobile Phone Number.
    - 2) Click on your country to display checkmark, then click **Finish**.
    - 3) Enter your mobile phone number, then press **Get Verification Code** button.
    - 4) Check your phone for the verification code that was texted, and enter it into the “Input the received verification code” field, then click the **Next** button.
    - 5) Create user name and password, re-type confirmation password, then click **Finish** button.
  - Using E-Mail Address:
    - 1) Click Register by E-Mail Address.
    - 2) Click on your country to display checkmark, then click the **Finish** button.
    - 3) Enter your e-mail address, then click the **Next** button.
    - 4) Check your e-mail for the verification code that was texted, and enter it into the “Input the received verification code” field, then click the **Next** button.
    - 5) Create user name and password, re-type confirmation password, then click **Finish** button.

### 16.2.3. Enable Hik-Connect P2P on the NVR.

1. Go to Main Menu > System Configuration > Network > Platform Access.
2. Check the Enable checkbox.
3. Server Address must be “dev.hik-connect.com.” If not, check the Custom checkbox, and type “dev.hik-connect.com.”
4. To turn Enable Stream Encryption on, select its checkbox.
5. Click the Apply button. Status will change to “Online” (if all settings are correct).
6. Note the Serial Number and Verification Code shown here (for use when registering the NVR in your Hik-Connect account) or use the QR code displayed.

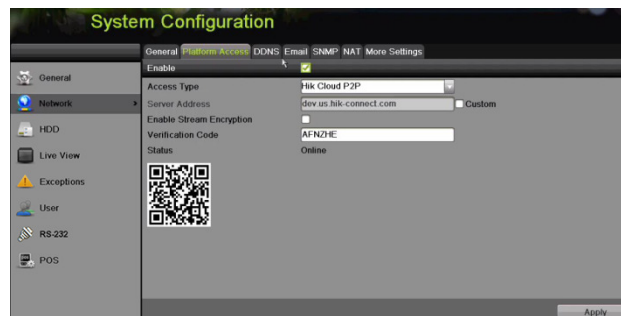

Figure 153, Hik-Connect Cloud P2P Settings Interface

### 16.2.4. Add the NVR to the Hik-Connect Service

To see a video stream on the Hik-Connect or iVMS-4500 mobile app, you must add the NVR.

1. Login to Hik-Connect mobile app with your user name, e-mail, or mobile number and password.
2. On the Home screen, click the “+” button (upper right corner).
3. Enter the device’s information.
  - If you have device’s **QR Code**: Use QR Code Scanner to scan **QR Code**.
  - If you do not have device’s **QR Code**: Enter device information manually:
    - 1) Click the Edit (pencil) icon on top right.
    - 2) Enter device serial number (device must be online), then click the **OK** button.
    - 3) When the device appears on the “Results” screen, click the **Add** button.
    - 4) Enter device’s 6-character Verification Code (all upper case), then click the **OK** button.
    - 5) Click the **Finish** button.

**NOTES:** For existing DVRs with Hik-Connect enabled, Hik-Connect will still be enabled if upgraded. If Hik-Connect is disabled then enabled for the first time, you must change the verification code if the encrypted verification code is the same as that of the configuration file, or if the



encrypted verification code is empty and the configuration file's verification code is "ABCDEF." Under either of these conditions, create a new verification code or delete the default code and input the same same default verification code.

### 16.2.5. Accessing the NVR

After configuration, you can access and manage the NVR on your mobile phone with the HIK-Connect Cloud P2P app (iOS or Android) or through the HIK-Connect website ([www.hik-connect.com](http://www.hik-connect.com)).

**NOTE:** For more help, see the help file on the Hik-Connect website at [www.hik-connect.com](http://www.hik-connect.com).

### 16.2.6. Configuring NTP Server

A Network Time Protocol (NTP) Server can be configured on your DVR to ensure accuracy of the system date/time.

1. Enter the Network Settings interface, Menu > Configuration > Network.
2. Select the NTP tab to enter the NTP Settings interface.

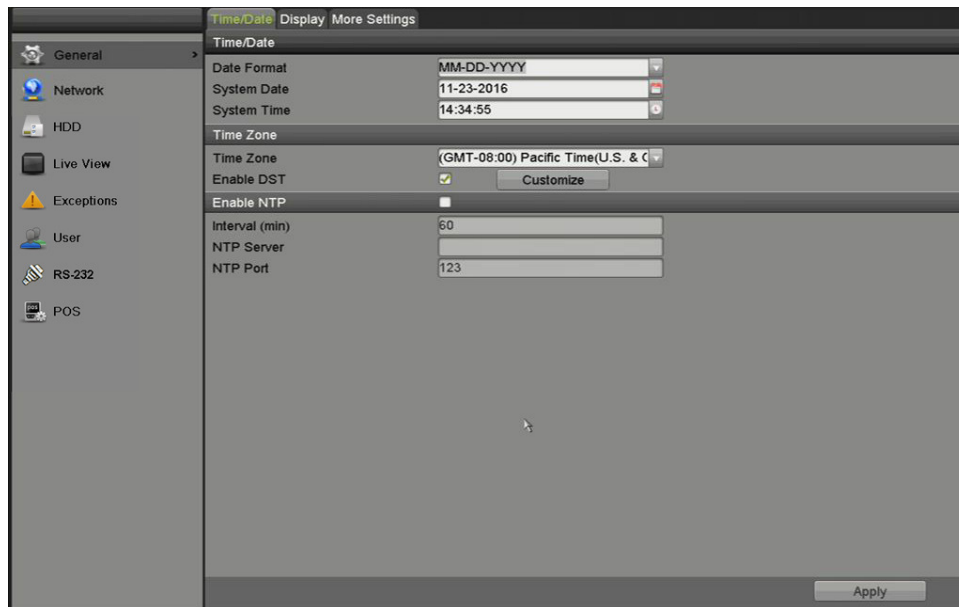

Figure 154, NTP Settings Interface

3. Check the Enable NTP checkbox to enable this feature.
4. Configure the following NTP settings:
  - Interval: Time interval between the two synchronizing actions with NTP server. The unit is minute.
  - NTP Server: IP address of NTP server
  - NTP Port: Port of NTP server
5. Click the Apply button to save and exit the interface.

**NOTE:** The time synchronization interval can be set from 1 to 10080 minutes. The default value is 60 minutes. If the DVR is connected to a public network, use an NTP server that has a time synchronization function such as the server at the National Time Center (IP Address: 210.72.145.44). If the DVR is set in a customized network, NTP software can be used to establish an NTP server used for time synchronization.

### 16.2.7. Configuring NAT

Universal Plug and Play (UPnP™) lets the device seamlessly discover the presence of other devices on the network and establish functional network services for data sharing, communications, etc. Use the UPnP™ function to quickly connect the device to the WAN via a router without port mapping.

**NOTE:** To enable the UPnP™ function of the device, you must enable the UPnP™ function of the router to which your device is connected. When the network working mode of the device is set as multi-address, the Default Route of the device should be in the same network segment as that of the LAN IP address of the router.

1. Enter the Network Settings interface, Menu > Configuration > Network.
2. Select the NAT tab to enter the UPnP™ Settings interface.

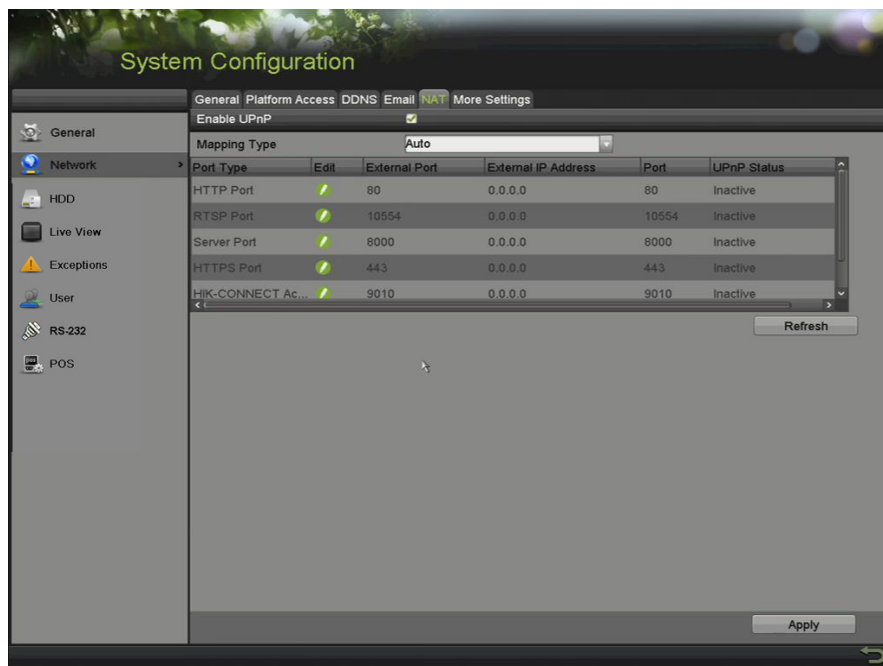

Figure 155, UPnP™ Settings Interface

3. Check Enable UPnP checkbox to enable UPnP™.
4. Select the Mapping Type as Manual or Auto in the drop-down list.

- **OPTION 1: Auto**

If you select Auto, the Port Mapping items are read-only, and the external ports are set by the router automatically.

- 1) Click the Apply button to save the settings.

2) Click the Refresh button to get the latest status of the port mapping.

- **OPTION 2: Manual**

1) If you select Manual as the mapping type, you can edit the external port on demand by clicking  to activate the External Port Settings dialog box.

2) Click  to activate the External Port Settings dialog box. Configure the external port No. for server port, http port, and RTSP port respectively.

**NOTE:** You can use the default port No., or change it according to actual requirements.

External Port indicates the port No. for port mapping in the router.

The RTSP port No. value should be 554 or between 1024 and 65535, while the value of the other ports should be between 1 and 65535, and the values must be different from each other. If multiple devices are configured for the UPnP™ settings under the same router, the value of the port No. for each device should be unique.



Figure 156, External Port Settings Dialog Box

3) Click Apply button to save the settings.

4) You can click Refresh button to get the latest status of the port mapping.

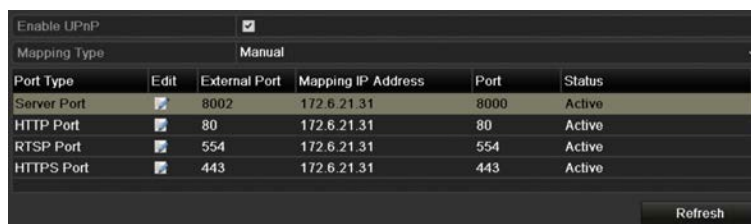

Figure 157, UPnP™ Settings Finished, Manual

### 16.2.8. Configuring More Settings

1. Enter the Network Settings interface, Menu > Configuration > Network.

2. Select the More Settings tab to enter the More Settings interface.



Figure 158, More Settings Interface

3. Configure the remote alarm host, server port, HTTP port, multicast, and RTSP port.

- **Alarm Host IP/Port:** With a remote alarm host configured, the device will send the alarm event or exception message to the host when an alarm is triggered. The remote alarm host must have the CMS (Client Management System) software installed.

The Alarm Host IP refers to the IP address of the remote PC on which the CMS (Client Management System) software (e.g., iVMS-4200) is installed, and the Alarm Host Port must be the same as the alarm monitoring port configured in the software (default port is 7200).

- **Multicast IP:** The multicast can be configured to realize live view for more than the maximum number of cameras through network. A multicast address spans the Class-D IP range of 224.0.0.0 to 239.255.255.255. It is recommended to use the IP address ranging from 239.252.0.0 to 239.255.255.255.

When adding a device to the CMS (Client Management System) software, the multicast address must be the same as the device's multicast IP.

- **RTSP Port:** The RTSP (Real Time Streaming Protocol) is a network control protocol designed for use in entertainment and communications systems to control streaming media servers.

Enter the RTSP port in the RTSP Port text field. The default RTSP port is 554, and you can change it according to different requirements.

- **Server Port and HTTP Port:** Enter the Server Port and HTTP Port in the text fields. The default Server Port is 8000 and the HTTP Port is 80, and you can change them according to different requirements.

**NOTE:** The Server Port should be set in the range of 2000-65535 and is used for remote client software access. The HTTP port is used for remote IE access.

- **Output Bandwidth Limit:** You can check the checkbox to enable output bandwidth limit.
- **Output Bandwidth:** After enabling the output bandwidth limit, input the output bandwidth in the text field.

**NOTE:** The output bandwidth limit is used for remote Live View and playback. The minimum output bandwidth is 2 Mbps.

4. Click the Apply button to save and exit the interface.

### 16.2.9. Configuring HTTPS Port

HTTPS provides authentication of the Web site and associated Web server that one is communicating with, which protects against man-in-the-middle attacks. Perform the following steps to set the https port number.

**Example:** If you set the port number to 443 and the IP address is 192.0.0.64, you may access the device by inputting https://192.0.0.64:443 via the Web browser.

**NOTE:** The HTTPS port can be configured only through the Web browser.

1. Open Web browser, input the IP address of device, and the Web server will select the language automatically according to the system language and maximize the Web browser.
2. Input the correct user name and password, and click the Login button to log in to the device.
3. Enter the HTTPS settings interface, Configuration > Remote Configuration > Network Settings > HTTPS
4. Create the self-signed certificate or authorized certificate.

The screenshot shows the HTTPS configuration page. At the top, there's a section for 'HTTPS' with a checked 'Enable HTTPS' checkbox. Below that, there are three main sections: 'Create', 'Install Signed Certificate', and 'Created Request'. The 'Create' section contains two buttons: 'Create Self-signed Certificate' and 'Create Certificate Request'. The 'Install Signed Certificate' section has a text input for 'Certificate Path' and 'Browse' and 'Upload' buttons. The 'Created Request' section has a text input for 'Created Request' and 'Delete' and 'Download' buttons. The 'Installed Certificate' section has a text input for 'Installed Certificate' and a 'Delete' button. A 'Save' button is at the bottom left.

Figure 159, HTTPS Settings

- **OPTION 1:** Create the self-signed certificate.
  - 1) Click the Create button to create the following dialog box.

Figure 160, Create Self-signed Certificate

- 2) Enter the country, host name/IP, validity, and other information.
  - 3) Click OK to save the settings.
- **OPTION 2:** Create the authorized certificate.
    - 1) Click the Create button to create the certificate request.
    - 2) Download the certificate request and submit it to the trusted certificate authority for signature.
    - 3) After receiving the signed valid certificate, import the certificate to the device.
    - 4) The certificate information will appear after you successfully create and install the certificate.

Figure 161, Installed Certificate Property

- 5) Check the checkbox to enable the HTTPS function.
- 6) Click the Save button to save the settings.

### 16.2.10. Configuring E-Mail

The system can be configured to send an e-mail notification to all designated users if an event is detected (e.g., an alarm or motion event is detected, etc.)

Before configuring the e-mail settings, the DVR must be connected to a local area network (LAN) that maintains an SMTP mail server. The network must also be connected to either an intranet or the Internet depending on the location of the e-mail accounts to which you want to send notification. Additionally, the Preferred DNS server must be configured.

**NOTE:** Make sure you have configured the IPv4 Address, IPv4 Subnet Mask, IPv4 Gateway, and the Preferred DNS Server in the Network Settings menu before starting.

1. Enter the Network Settings interface, Menu > Configuration > Network.
2. Select the E-mail tab to enter the E-mail Settings interface.

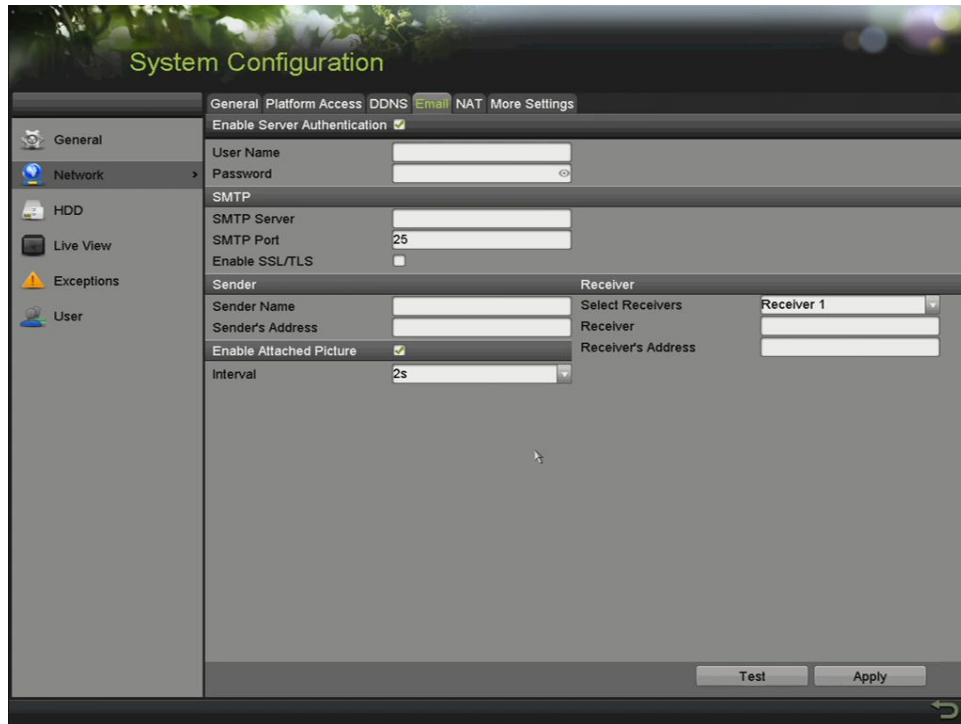

Figure 162, E-mail Settings Interface

3. Configure the following e-mail settings:

- **Enable Server Authentication (optional):** Check the checkbox to enable the server authentication feature.
- **User Name:** The user account of sender's e-mail for SMTP server authentication.
- **Password:** The password of sender's e-mail for SMTP server authentication.
- **SMTP Server:** The SMTP Server IP address or host name (e.g., smtp.263xmail.com).
- **SMTP Port:** The SMTP port. The default TCP/IP port used for SMTP is 25.
- **Enable SSL (optional):** Click the checkbox to enable SSL if required by the SMTP server.
- **Sender:** The name of sender.
- **Sender's Address:** The e-mail address of sender.
- **Select Receivers:** Select the receiver. Up to three receivers can be configured.
- **Receiver:** The name of the e-mail receiver.
- **Receiver's Address:** The e-mail address of the receiver.
- **Enable Attached Picture:** Check this checkbox if you want to send e-mail with attached alarm images. The interval is the time between two captures of the alarm images.

**NOTE:** Three attached pictures can be sent for one analog camera when the alarm is triggered.

- **Interval:** Refers to the time between two actions of sending attached pictures.
- **E-mail Test:** Sends a test message to verify the SMTP server can be reached.

4. Click the Apply button to save the e-mail settings.
5. Click the Test button to test whether your E-mail settings work. The corresponding Attention message box pops up.

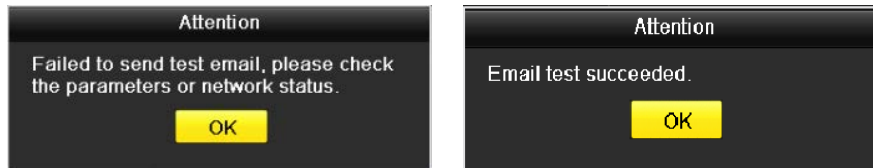

Figure 163, E-Mail Testing Attention

### 16.2.11. Checking Network Traffic

You can check the network traffic to obtain real-time information of DVR such as linking status, MTU, sending/receiving rate, etc.

1. Enter the Network Traffic interface, Menu > Maintenance > Net Detect.

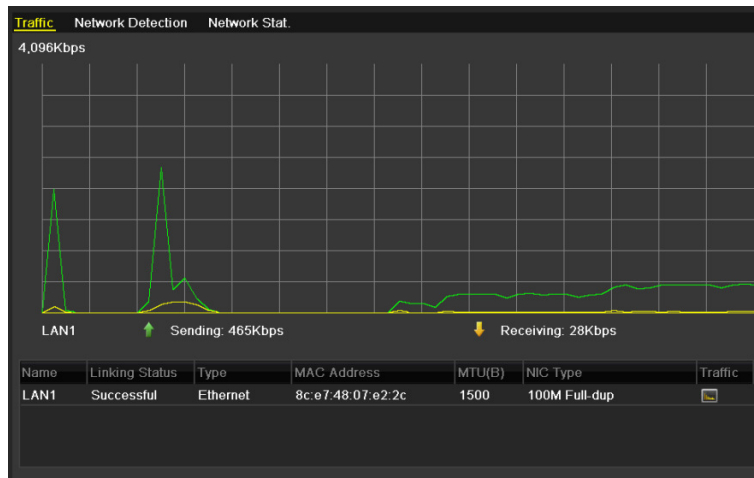

Figure 164, Network Traffic Interface

2. You can view the sending rate and receiving rate information on the interface. The traffic data is refreshed every second.

## 16.3. Configuring Network Detection

You can obtain network connecting status of the DVR through the network detection function, including network delay, packet loss, etc.

### 16.3.1. Testing Network Delay and Packet Loss

1. Enter the Network Traffic interface, Menu > Maintenance > Net Detect.
2. Click the Network Detection tab to enter the Network Detection interface.



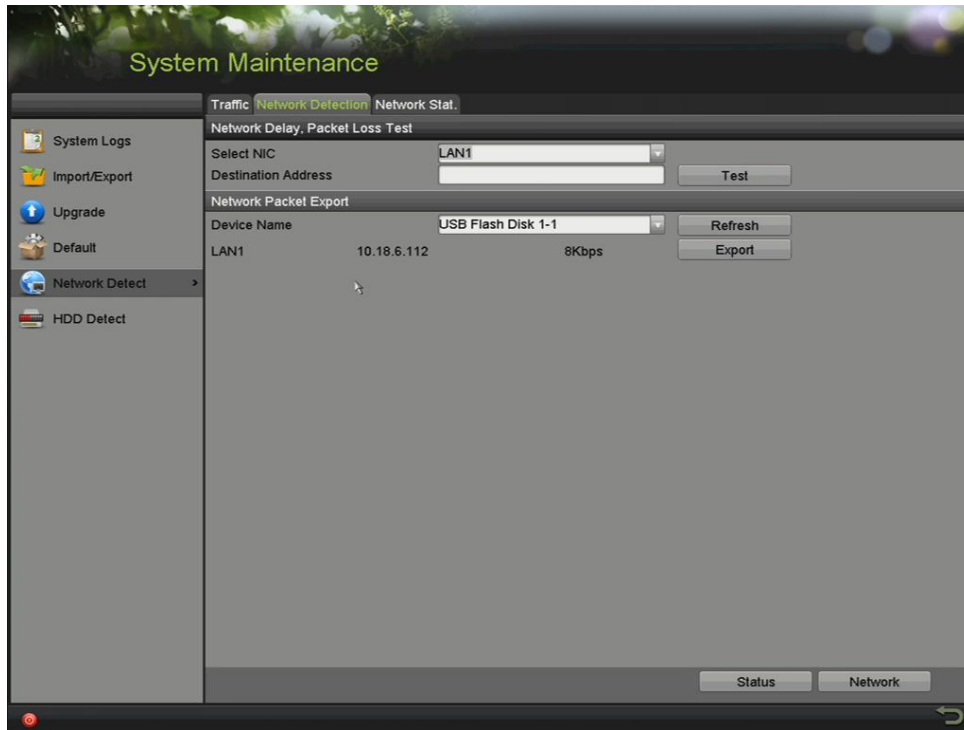

Figure 165, Network Detection Interface

3. Select a NIC to test network delay and packet loss.
4. Enter the destination address in the Destination Address text field.
5. Click the Test button to start testing network delay and packet loss.

### 16.3.2. Exporting Network Packet

By connecting the DVR to a network, the captured network data packet can be exported to a USB flash disk, SATA, and other local backup devices.

1. Enter the Network Traffic interface, Menu > Maintenance > Net Detect.
2. Click the Network Detection tab to enter the Network Detection interface.
3. Select the backup device from the Device Name drop-down list.

**NOTE:** Click the Refresh button if the connected local backup device cannot be displayed. If it fails to detect the backup device, check whether it is compatible with the DVR. Format the backup device if the format is incorrect.

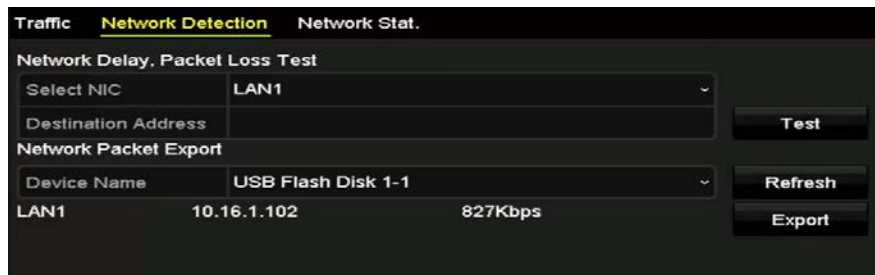

Figure 166, Export Network Packet

4. Click the Export button to start exporting.
5. After the export is complete, click OK to finish the packet export.

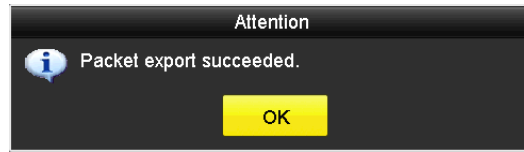

Figure 167, Packet Export Attention

**NOTE:** Up to 1 MB of data can be exported each time.

### 16.3.3. Checking Network Status

You can also check the network status and quick set the network parameters in this interface.

1. Enter the Network Traffic interface, Menu > Maintenance > Net Detect.
2. Click the Network Detection tab to enter the Network Detection interface.
3. Click Status on the right bottom of the interface.

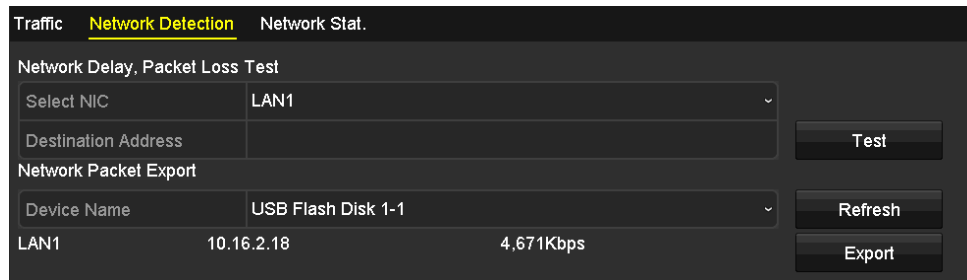

Figure 168, Checking Network Status

4. If the network is normal the following message box pops out.

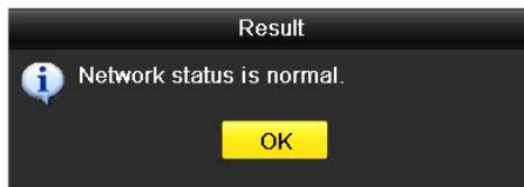

Figure 169, Network Status Checking Result

5. If the message box pops out with other information instead of this, click the Network button to show the quick setting interface of the network parameters.

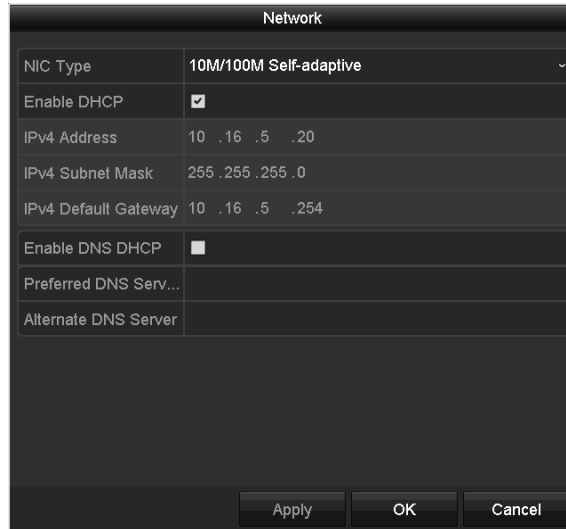

Figure 170, Network Parameters Configuration

### 16.3.4. Checking Network Statistics

You can check the network statistics to obtain the real-time information of the device.

1. Enter the Network Statistics interface, Menu > Maintenance> Net Detect.
2. Click the Network Stat. tab to enter the Network Statistics interface.

Type	Bandwidth
IP Camera	8.192Kbps
Remote Live View	0bps
Remote Playback	0bps
Net Total Idle	88Mbps

**Refresh**

Figure 171, Network Stat. Interface

3. View the Remote Live View bandwidth, Remote Playback bandwidth, and Net Total Idle bandwidth.
4. Click Refresh button to get the latest bandwidth statistics.

# 17. HDD Management

## 17.1. Initializing HDDs

A newly installed hard disk drive (HDD) must be initialized before it can be used with the DVR.

**NOTE:** Systems with HDDs installed at the factory come pre-initialized.

1. Enter the HDD Information interface, Menu > HDD > General.

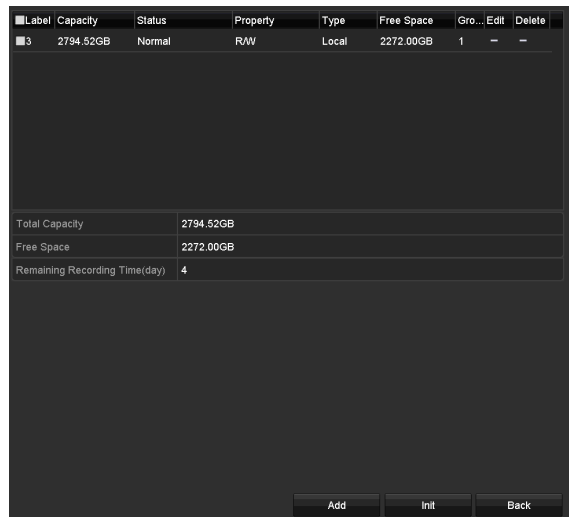

Figure 172, HDD Information Interface

2. View HDD's Total Capacity, Free Space, and Remaining Recording Time (this uses the average bit rate for the channel, allowing smart encoding to increase accuracy).
3. Select the HDD to be initialized.
4. Click the Init button.

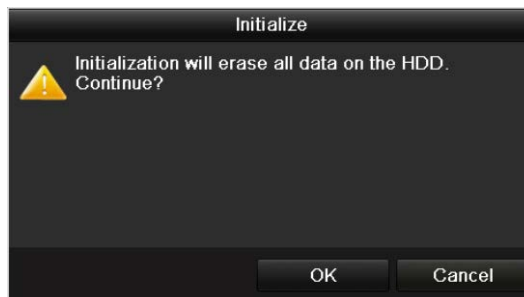

Figure 173, Confirm Initialization

5. Select the OK button to start initialization.

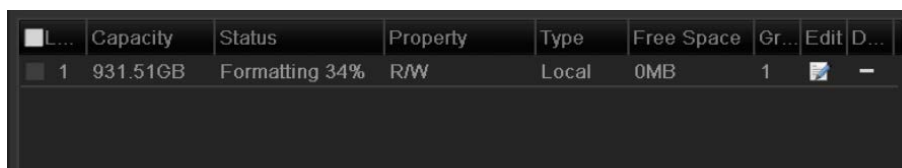
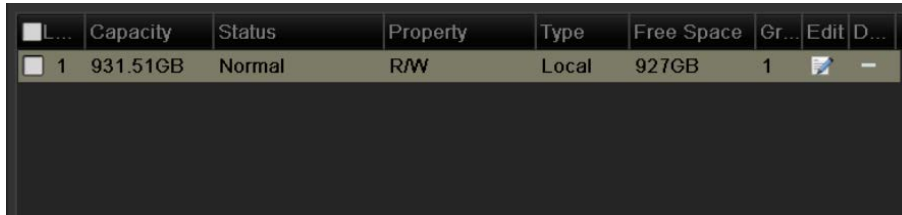

Figure 174, Start Initialization

6. After the HDD has been initialized, the status of the HDD will change from *Uninitialized* to *Normal*.



L...	Capacity	Status	Property	Type	Free Space	Gr...	Edit	D...
1	931.51GB	Normal	R/W	Local	927GB	1		

Figure 175, HDD Status Changes to Normal

**NOTE:** Initializing the HDD will erase all data on it.

HDDs that are free from working for a long period of time can be put to sleep to decrease the power consumption of the device and extend its life.

7. Click Menu > HDD > Advanced.

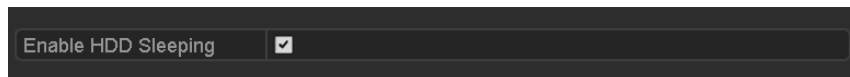

Figure 176, Enable HDD Sleeping

8. Check (default) the Enable HDD Sleeping checkbox, and the HDDs which are free from working for awhile will be set to sleep.
9. Uncheck the Enable HDD Sleeping checkbox, and the HDDs will be set to work all the time.

## 17.2. Managing Network HDD

You can add an allocated NAS or IP SAN disk to the DVR and use it as a network HDD.

1. Enter the HDD Information interface, Menu > HDD > General.

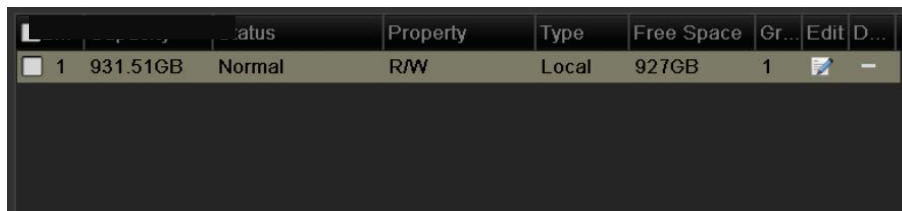

L...	Capacity	Status	Property	Type	Free Space	Gr...	Edit	D...
1	931.51GB	Normal	R/W	Local	927GB	1		

Figure 177, HDD Information Interface

2. Click the Add button to enter the Add NetHDD interface.

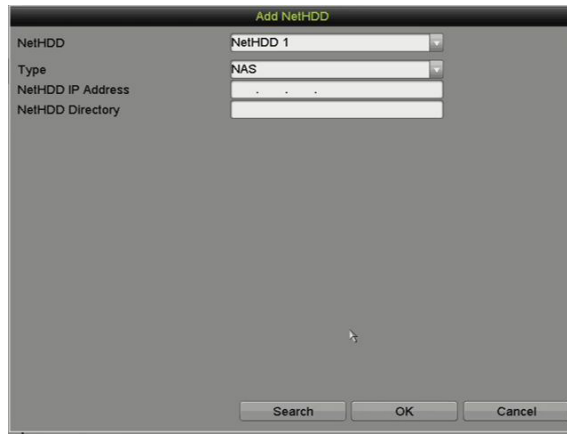

Figure 178, NetHDD Information Interface

3. Add the allocated NetHDD.
4. Select type as NAS or IP SAN.
5. Configure the NAS or IP SAN settings.
  - **Adding a NAS Disk**
    - 1) Enter the NetHDD IP address in the text field.
    - 2) Click Search to search the available NAS disks.
    - 3) Select a NAS disk from the list or manually enter the directory in the NetHDD Directory text field.
    - 4) Click OK to add the configured NAS disk.

**NOTE:** Up to eight NAS disks can be added.

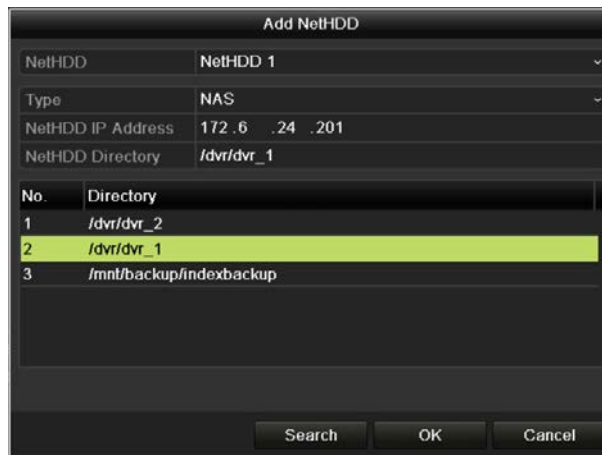

Figure 179, Add NAS Disk

- **Adding an IP SAN Disk**
  - 1) Enter the NetHDD IP address in the text field.
  - 2) Click the Search button to find the available IP SAN disks.

- 3) Select the IP SAN disk from the list shown.
- 4) Click the OK button to add the selected IP SAN disk.

**NOTE:** Up to eight IP SAN disks can be added.

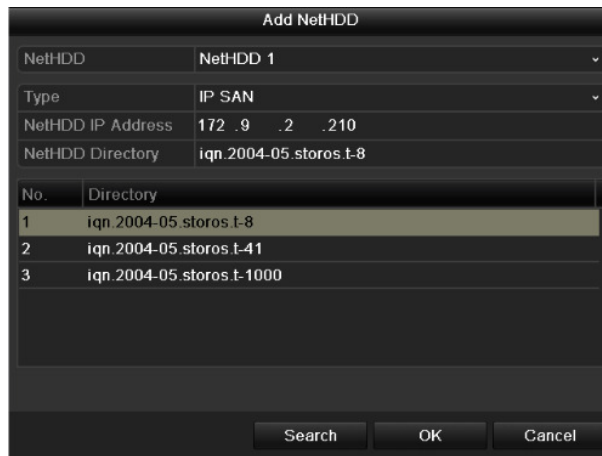

Figure 180, Add IP SAN Disk

6. After having successfully added the NAS or IP SAN disk, return to the HDD Information menu. The added NetHDD will be displayed in the list.

**NOTE:** If the added NetHDD is uninitialized, select it and click the Init button for initialization.

<input type="checkbox"/> L...	Capacity	Status	Property	Type	Free Space	Gr...	Edit	D...
<input checked="" type="checkbox"/> 1	931.51GB	Normal	R/W	Local	906GB	1		
<input checked="" type="checkbox"/> 17	40,000MB	Normal	R/W	IP SAN	22,528MB	1		

Figure 181, Initialize Added NetHDD

## 17.3. Managing HDD Groups

### 17.3.1. Setting HDD Groups

Multiple HDDs can be managed in groups. Record video from specified channels to a particular HDD group through HDD settings.

1. Enter the Storage Mode interface, Menu > HDD > Advanced.
2. Set the Mode to Group.

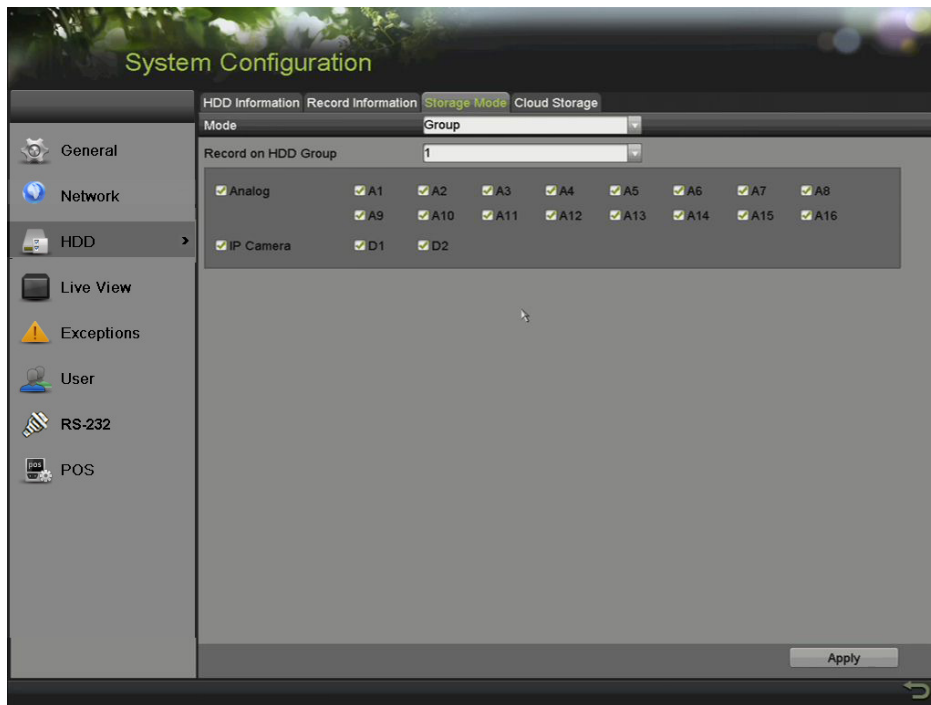

Figure 182, Storage Mode Interface

3. Click the Apply button and the following Attention box will pop up.

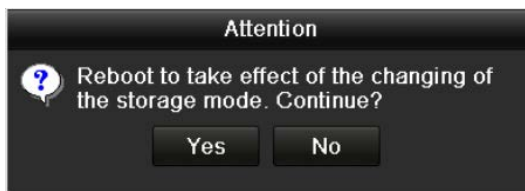



Figure 183, Attention for Reboot

4. Click the Yes button to reboot the device and activate the changes.
5. After reboot of device, enter the HDD Information interface, Menu > HDD > General.
6. Select HDD from the list and click the  icon to enter the Local HDD Settings interface.

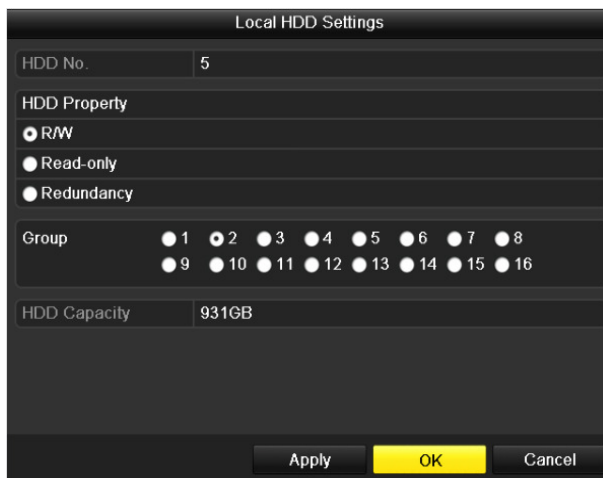

Figure 184, Local HDD Settings Interface



7. Select the Group number for the current HDD.  
**NOTE:** The default group No. for each HDD is 1.
8. Click the OK button to confirm the settings.



Figure 185, Confirm HDD Group Settings

9. In the pop-up Attention box, click the Yes button to finish the settings.

### 17.3.2. Setting HDD Property

The HDD property can be set to redundancy, read-only, or read/write (R/W). Before setting the HDD property, set the storage mode to Group. An HDD can be set to read-only to prevent important recorded files from being overwritten when the HDD becomes full in overwrite recording mode.

When the HDD property is set to redundancy, the video can be recorded both onto the redundant HDD and the R/W HDD simultaneously to ensure high security and reliability of video data.

1. Enter the HDD Information interface, Menu > HDD > General.
2. Select an HDD from the list and click the  icon to enter the Local HDD Settings interface.



Figure 186, Set HDD Property

3. Set the HDD property to R/W, Read-only, or Redundancy.
4. Click the OK button to save the settings and exit the interface.
5. In the HDD Information menu, the HDD property will be displayed in the list.

**NOTE:** At least two hard disks must be added on your DVR to set a HDD to Redundancy, and there must be one HDD with R/W property.

## 17.4. Configuring Quota Mode

Each camera can be configured with allocated quota for the storage of recorded files.

1. Enter the Storage Mode interface, Menu > HDD > Advanced.
2. Click the Storage Mode tab.
3. Set the Mode to Quota.
4. Reboot the DVR to enable the changes to take effect.

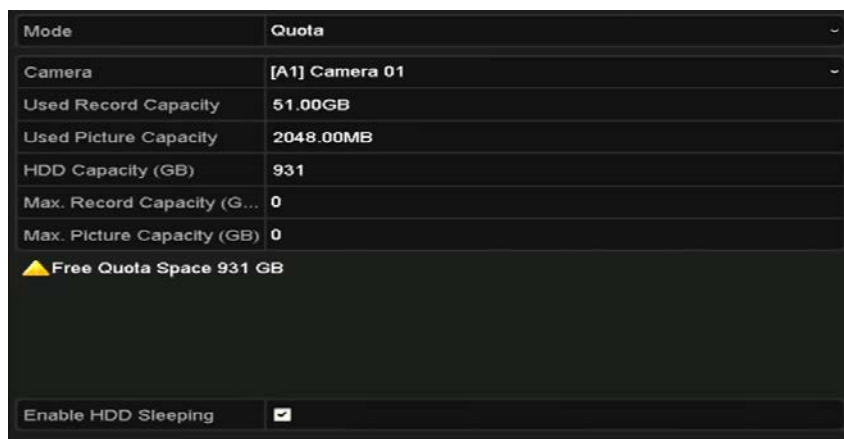

Figure 187, Storage Mode Settings Interface

5. Select a camera for which you want to configure quota.
6. Enter the storage capacity in the Max. Record Capacity (GB) text field.
7. To copy the quota settings of the current camera to other cameras if desired, click the Copy button to enter the Copy Camera interface.



Figure 188, Copy Settings to Other Camera(s)

8. Select the camera(s) to be configured with the same quota settings. You can also click the Analog checkbox to select all cameras.
9. Click the OK button to finish the Copy settings and go back to the Storage Mode interface.

10. Click the Apply button to apply the settings.

**NOTE:** If the quota capacity is set to 0, then all cameras will use the total capacity of the HDD to record.

## 17.5. Configuring Cloud Storage

Cloud storage allows uploading and downloading of recorded files anytime and anyplace.

1. Enter the Cloud Storage interface, Menu > HDD > General > Cloud Storage.
2. Check the Enable Cloud checkbox to enable the feature.
3. Select the One Drive, Google Drive, or Dropbox Cloud Type from the drop-down list.

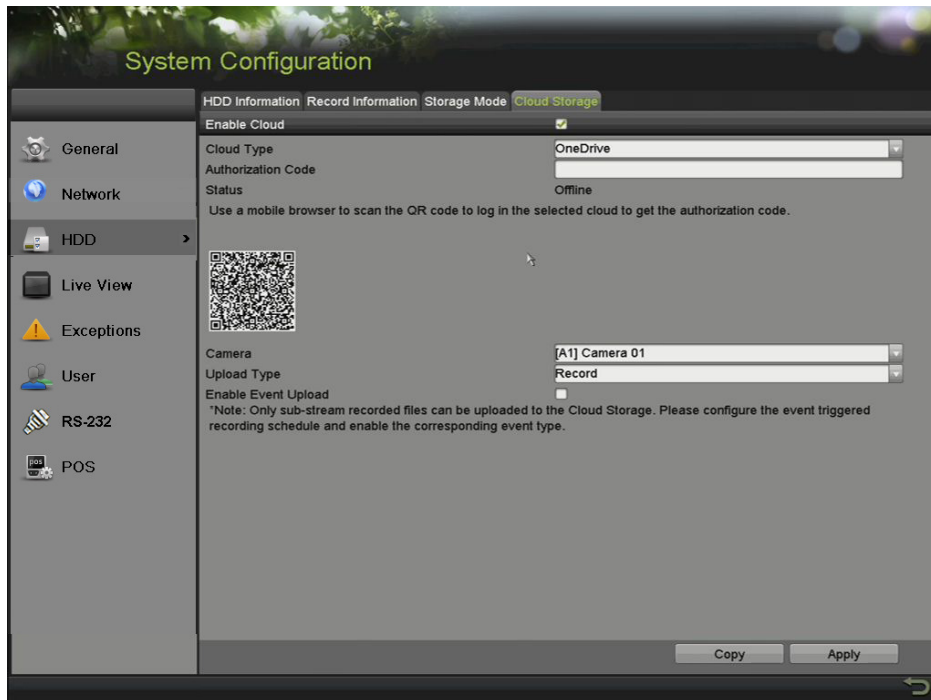

Figure 189, Cloud Storage Interface

4. Follow the prompts and use a mobile browser to scan the QR code to log in to the selected cloud to get the authentication code, and then copy the authentication code to the Authentication Code text field.
5. Click Apply to save the settings and return to the main menu.
6. Re-enter the cloud storage interface after 20 seconds. The Status will indicate successful registration.
7. Configure the recording schedule by going to the record interface, choose a camera from the Camera drop-down list, and check the Enable Schedule checkbox to enable the schedule recording.

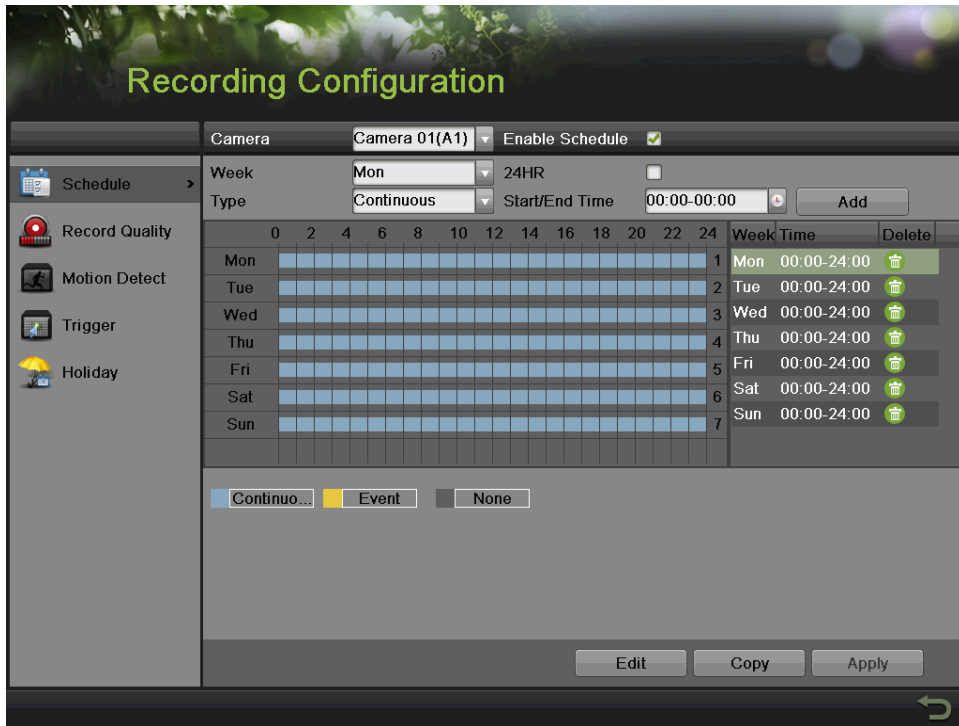

Figure 190, Record Schedule

8. Upload the event triggered recording files to the cloud storage.
9. Enter the cloud storage interface and select the camera you have set in the recording schedule interface.
10. Select the upload type (default is Record) in the Upload Type text filed.
11. Check the Enable Event Upload checkbox.
12. Click Apply to finish the settings.



Figure 191, Upload to Cloud Storage Interface

**NOTE:** Only the sub-stream recorded files can be uploaded to the cloud storage.

Configure the event triggered recording schedule and enable the corresponding event type.

13. (Optional) Click the Copy button to copy the cloud storage settings to other cameras. You can also click the Analog/IP Camera checkbox to select all cameras.
14. Click OK button to go back to the cloud storage interface.
15. Click Apply to finish the settings.



Figure 192, Copy to Interface

## 17.6. Checking HDD Status

Check the status of the installed HDDs on the DVR so as to take immediate check and maintenance in case of HDD failure.

### 17.6.1. Checking HDD Status in HDD Information Interface

1. Enter the HDD Information interface, Menu > HDD > General.
2. Check the status of each HDD displayed on the list.

L...	Capacity	Status	Property	Type	Free Space	Gr...	Edit	D...
1	931.51GB	Normal	R/W	Local	900GB	1		-
17	199.97GB	Normal	Redundancy	NAS	182GB	1		

Figure 193, View HDD Status (1)

**NOTE:** If the HDD status is *Normal* or *Sleeping*, it is working normally. If the status is *Uninitialized* or *Abnormal*, initialize the HDD before use. If the HDD initialization fails, replace the HDD.

### 17.6.2. Checking HDD Status in System Information Interface

1. Enter the System Information interface, Menu > Maintenance > System Info.
2. Click the HDD tab to view the status of each HDD on the list.

Label	Status	Capacity	Free Space	Property	Type	Group
1	Normal	931.51GB	900GB	R/W	Local	1
17	Normal	199.97GB	182GB	Redundancy	NAS	1

Figure 194, View HDD Status (2)

## 17.7. Checking S.M.A.R.T. Information

The S.M.A.R.T. (Self-Monitoring, Analysis and Reporting Technology) is a monitoring system for HDD to detect and report on various indicators of reliability in the hopes of anticipating failures.

1. Enter the HDD Detect interface, Menu > Maintenance > HDD Detect.
2. Click the S.M.A.R.T. Settings tab to enter the interface.
3. Select the HDD to view its S.M.A.R.T. information list.

**NOTE:** To use the HDD even when S.M.A.R.T. checking has failed, check the Continue checkbox.

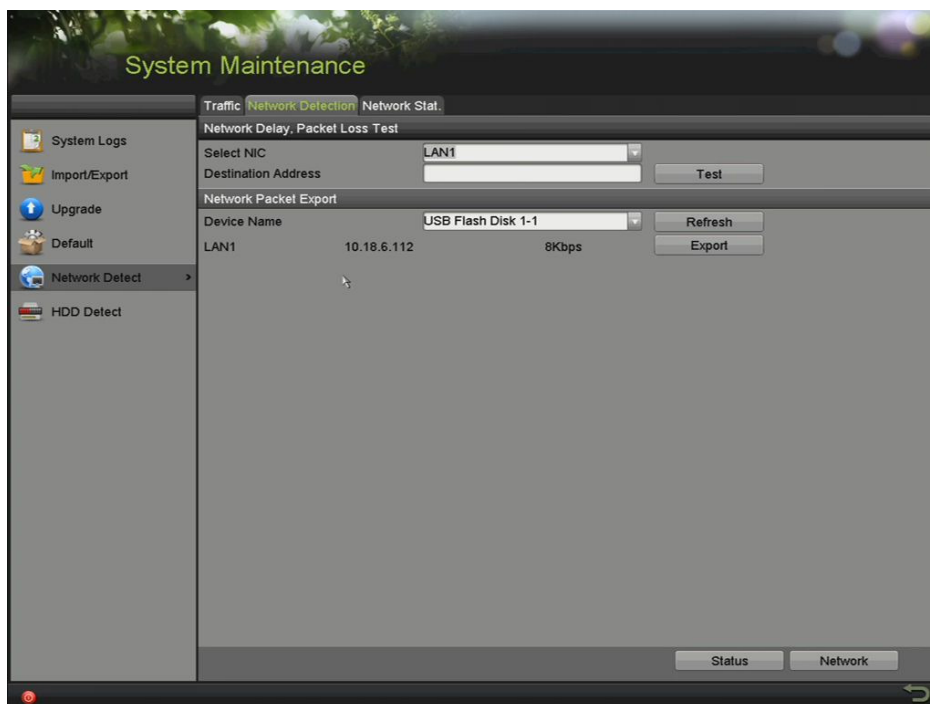

Figure 195, S.M.A.R.T. Settings Interface

## 17.8. Detecting Bad Sectors

You can detect bad HDD sectors.

1. Enter the HDD Detect interface, Menu > HDD > HDD Detect.
2. Click the Bad Sector Detection tab to enter the interface.
3. Select an HDD and click the Detect button to start detecting.



Figure 196, Bad Sector Detecting

4. Click the Pause button to pause the detection and click the Resume button to resume the detection.
5. If there is error information about the HDD, click the Error Info button to view the information.

## 17.9. Configuring HDD Error Alarms

You can configure the HDD *Uninitialized* or *Abnormal* error alarms.

1. Enter the Exception interface, Menu > Configuration > Exceptions.
2. Select the HDD Error Exception Type from the drop-down list.
3. Check the checkbox(s) to select the HDD error linkage action(s): Audible Warning, Notify Surveillance Center, Send E-mail, and Trigger Alarm Output.

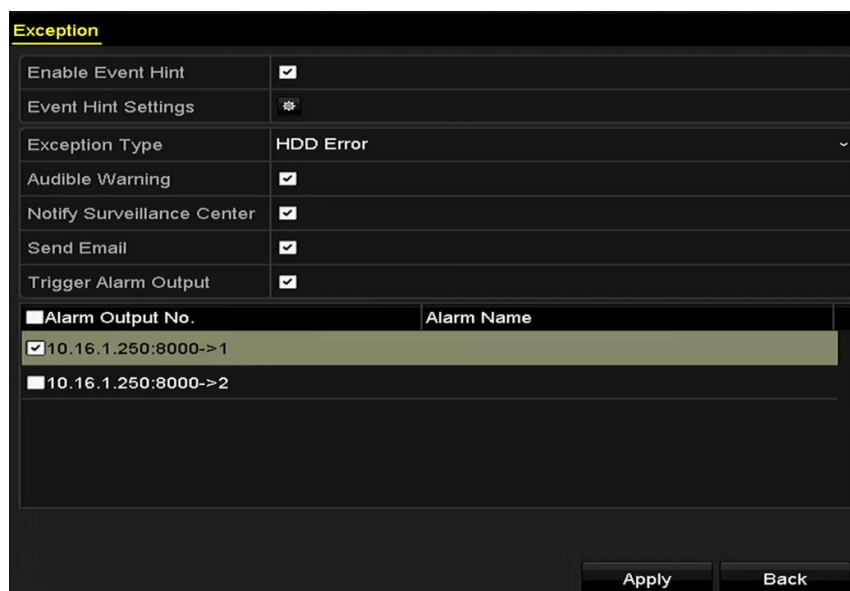

---

Figure 197, Configure HDD Error Alarm

4. When Trigger Alarm Output is selected, also select the alarm output to be triggered from the list below.
5. Click the Apply button to save the settings.



# 18. RAID Setup

## 18.1. Configuring Array

RAID (redundant array of independent disks) is a storage technology that combines multiple disk drive components into a logical unit. A RAID setup stores data over multiple hard disk drives to provide enough redundancy so that data can be recovered if one disk fails. Data is distributed across the drives in one of several ways called “RAID levels,” depending on what level of redundancy and performance is required.

The NVR supports software-based disk array. You can enable the RAID function at your demand.

**NOTE:** DS-73xxHUHI-F4/N Series DVRs support RAID 0, RAID 1, RAID 5, RAID 6, and RAID 10 array types.

### 18.1.1. Before You Start

Install the HDD(s) properly and it is recommended to use the same enterprise-level HDDs (including model and capacity) for array creation and configuration so as to maintain reliable and stable running of the disks.

### 18.1.2. Introduction

The NVR can store the data (such as record, picture, log information) in the HDD only after you have created the array or you have configured a network HDD (refer to Chapter **Error! Reference source not found. Error! Reference source not found.**). Our device provides two ways for creating an array, including one-touch configuration and manual configuration. The following flow chart shows the process of creating an array.

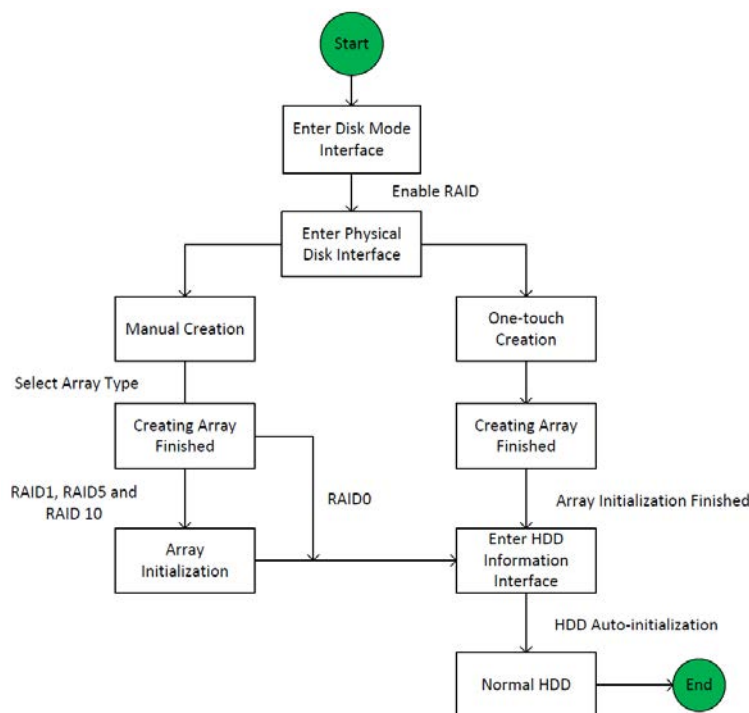

Figure 198 RAID Working Flow

### 18.1.3. Enable RAID

Perform the following steps to enable the RAID function, or the disk array cannot be created.

- **OPTION 1:** Enable the RAID function in the Wizard when the device starts up, refer to step 7 of Chapter 2.2.
  - **OPTION 2:** Enable the RAID function in the HDD Management Interface.
1. Enter the disk mode configuration interface, Menu > HDD > Advanced.

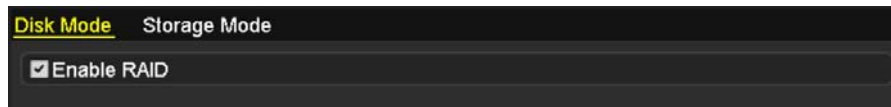

Figure 199 Enable RAID Interface

2. Check the checkbox of **Enable RAID**.
3. Click the **Apply** button to save the settings.

### 18.1.4. One-Touch Configuration

Through one-touch configuration, you can quickly create the disk array. By default, the array type to be created is RAID 5.

**NOTE:** Before You Start. The RAID function should be enabled, refer to Section 18.1.3.

As the default array type is RAID 5, please install at least three HDDs in your device.

If more than 10 HDDs are installed, two arrays can be configured.

1. Enter the RAID configuration interface, Menu > HDD > RAID.

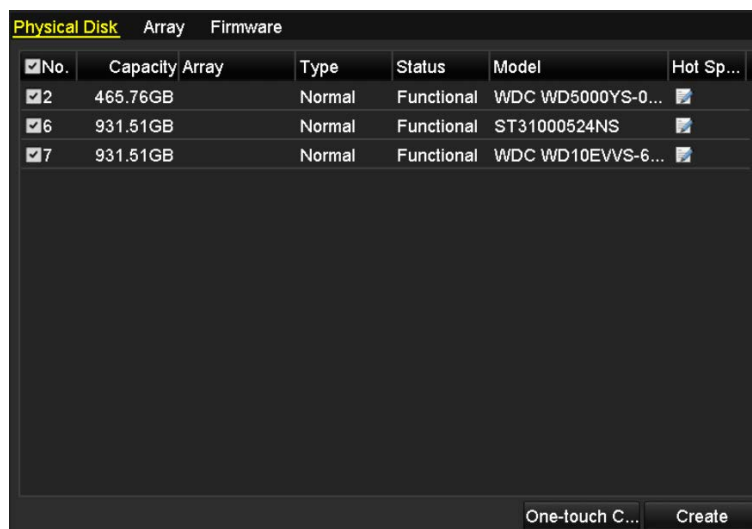

Figure 200 Physical Disk Interface

2. Check the corresponding HDD No. checkbox to select it.

- Click the **One-touch Create** button to enter the One-touch Array Configuration interface.

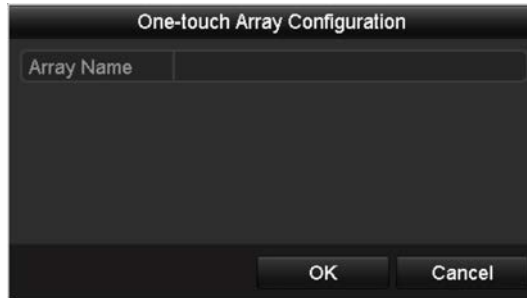

Figure 201 One-Touch Array Configuration

- Edit the array name in the **Array Name** text field and click **OK** button to start configuring array.

**NOTE:** If you install four HDDs or above for one-touch configuration, a hot spare disk will be set by default. It is recommended to set a hot spare disk to automatically rebuild the array when the array is abnormal.

- When the array configuration is done, click the **OK** button in the pop-up message box to finish.
- You can click **Array** tab to view the information of the successfully created array.

**NOTE:** By default, one-touch configuration creates an array and a virtual disk.

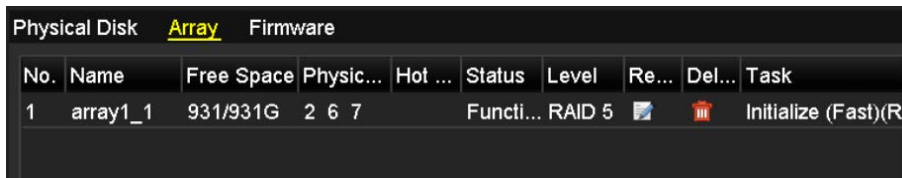

Figure 202 Array Settings Interface

- A created array displays as an HDD in the HDD information interface.

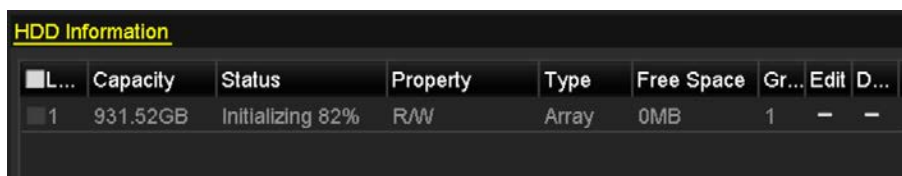

Figure 203 HDD Information Interface

### 18.1.5. Manually Creating Array

You can manually create the array of RAID 0, RAID 1, RAID 5, RAID6 and RAID 10.

**NOTE:** In this section, we take RAID 5 as an example to describe manually configuring arrays and virtual disks.

- Enter the Physical Disk Settings interface, Menu > HDD > RAID > Physical Disk.

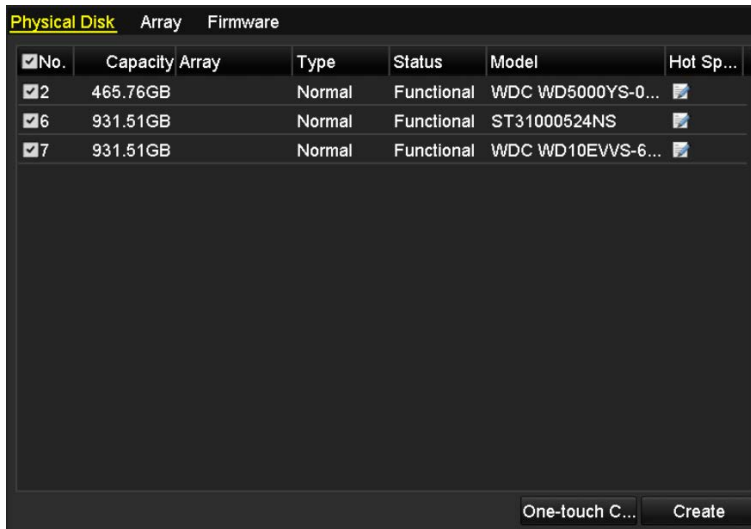

Figure 204 Physical Disk Settings Interface

2. Click Create button to enter the Create Array interface.

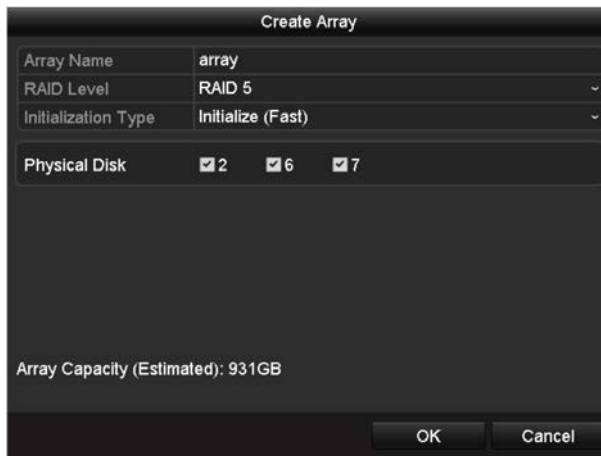

Figure 205 Create Array Interface

3. Edit the Array Name; set the RAID Level to RAID 0, RAID 1, RAID 5, RAID 6, or RAID 10; select the Physical Disk that you want to configure array.

NOTES:

- If you choose RAID 0, at least two HDDs must be installed.
- If you choose RAID 1, two HDDs need to be configured for RAID 1.
- If you choose RAID 5, at least three HDDs must be installed.
- If you choose RAID 6, at least four HDDs must be installed.
- If you choose RAID 10, the number of HDDs installed should be even, in the range of 4 to 16.

4. Click OK button to create array.

**NOTE:** If the number of HDDs you select is not compatible with the requirement of the RAID level, the error message box will pop up.



Figure 206 Error Message Box

5. You can click Array tab to view the successfully created array.

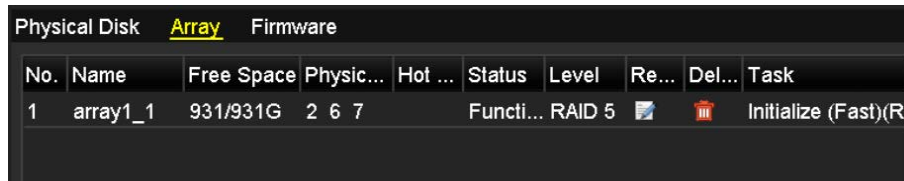

Figure 207 Array Settings Interface

## 18.2. Rebuilding Array

The array working status includes Functional, Degraded, and Offline. By viewing the array status, you can take immediate and proper maintenance of the disks to ensure high data security and reliability.

If there is no disk loss in the array, the working status will be Functional; if the number of lost disks has exceeded the limit, the working status will change to Offline; in other conditions, the working status is Degraded.

When the virtual disk is in Degraded status, you can restore it to Functional by array rebuilding.

### 18.2.1. Before You Start

Make sure the hot spare disk is configured.

1. Enter the Physical Disk Settings interface to configure the hot spare disk.

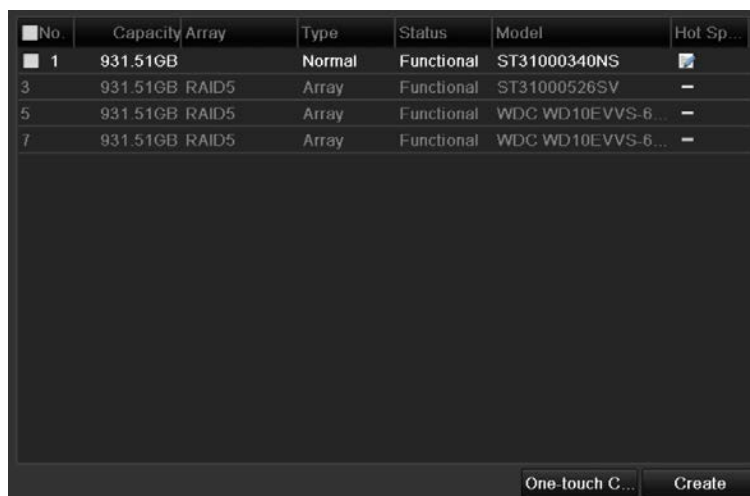

Figure 208 Physical Disk Settings Interface

2. Select a disk and click to set it as the hot spare disk.

**NOTE:** Only global hot spare mode is supported.

### 18.2.2. Automatically Rebuilding Array

When the virtual disk is in Degraded status, the device can rebuild the array automatically with the hot spare disk to ensure the high security and reliability of the data.

1. Enter the Array Settings interface, Menu > HDD > RAID > Array. The array status is Degraded. Since the hot spare disk is configured, the system will automatically use it to start rebuilding,

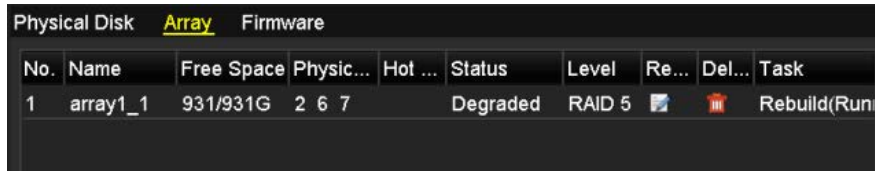

No.	Name	Free Space	Physic...	Hot ...	Status	Level	Re...	Del...	Task
1	array1_1	931/931G	2 6 7		Degraded	RAID 5			Rebuild(Run)

Figure 209 Array Settings Interface

**NOTE:** If there is no hot spare disk after rebuilding, it is recommended to install a HDD into the device and set it as a hot spare disk to ensure high security and reliability of the array.

### 18.2.3. Manually Rebuilding Array

If the hot spare disk has not been configured, you can rebuild the array manually to restore the array when the virtual disk is in Degraded status.

1. Enter the Array Settings interface, Menu > HDD > RAID > Array. In this example, disk 3 is lost.

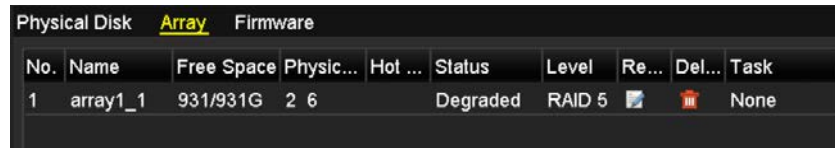

No.	Name	Free Space	Physic...	Hot ...	Status	Level	Re...	Del...	Task
1	array1_1	931/931G	2 6		Degraded	RAID 5			None

Figure 210 Array Settings Interface

2. Click Array tab to back to the Array Settings interface and click to configure the array rebuild.

**NOTE:** At least one available physical disk must exist for rebuilding the array.

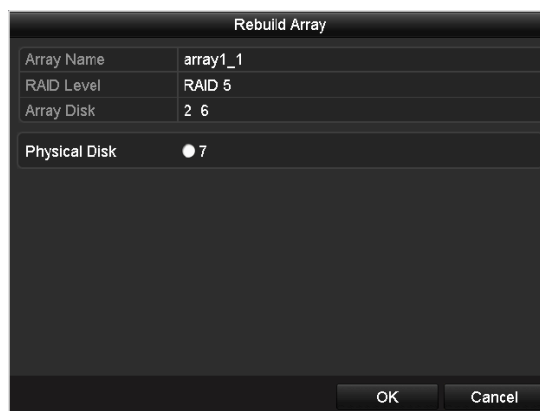

Rebuild Array	
Array Name	array1_1
RAID Level	RAID 5
Array Disk	2 6
Physical Disk	<input checked="" type="radio"/> 7

OK Cancel

Figure 211 Rebuild Array Interface

3. Select the available physical disk and click OK button to confirm rebuilding the array.
4. When “Do not unplug the physical disk when it is under rebuilding” message appears, click OK.
5. Enter the Array Settings interface to view the rebuilding status.
6. After rebuilding is successfully, the array and virtual disk will restore to Functional.

### 18.3. Deleting Array

**NOTE:** Deleting the array will delete all data in the array.

1. Enter the Array Settings interface, Menu > HDD > RAID > Array.

No.	Name	Free Space	Physic...	Hot ...	Status	Level	Re...	Del...	Task
1	array_1	931/931G	2 7 10		Functi...	RAID 5	[Rebuild icon]	[Delete icon]	None

Figure 212 Array Settings Interface

2. Select an array and click to delete the array.



Figure 213 Confirm Array Deletion

3. In the pop-up message box, click Yes button to confirm the array deletion.

### 18.4. Checking and Editing Firmware

You can view the firmware information and set the background task speed on the Firmware interface.

1. Enter the Firmware interface to check the firmware information, including version, maximum physical disk quantity, maximum array quantity, auto-rebuild status, etc.

Physical Disk		Array	Firmware
Version	1.1.0.0002		
Physical Disk Count	16		
Array Count	16		
Virtual Disk Count	0		
RAID Level	0 1 5 10		
Hot Spare Type	Global Hot Spare		
Support Rebuild	Yes		
Background Task Speed	Medium Speed		

Figure 214 Firmware Interface

- 
2. Set the Background Task Speed in the drop-down list.
  3. Click the Apply button to save the settings.



# 19. POS Configuration

## 19.1. Configuring POS Settings

1. Enter the POS settings interface, Menu > Configuration > POS > POS Settings.
2. Select the POS from the drop-down list. Up to eight POS units are selectable.
3. Check the **Enable** checkbox to enable the POS function.

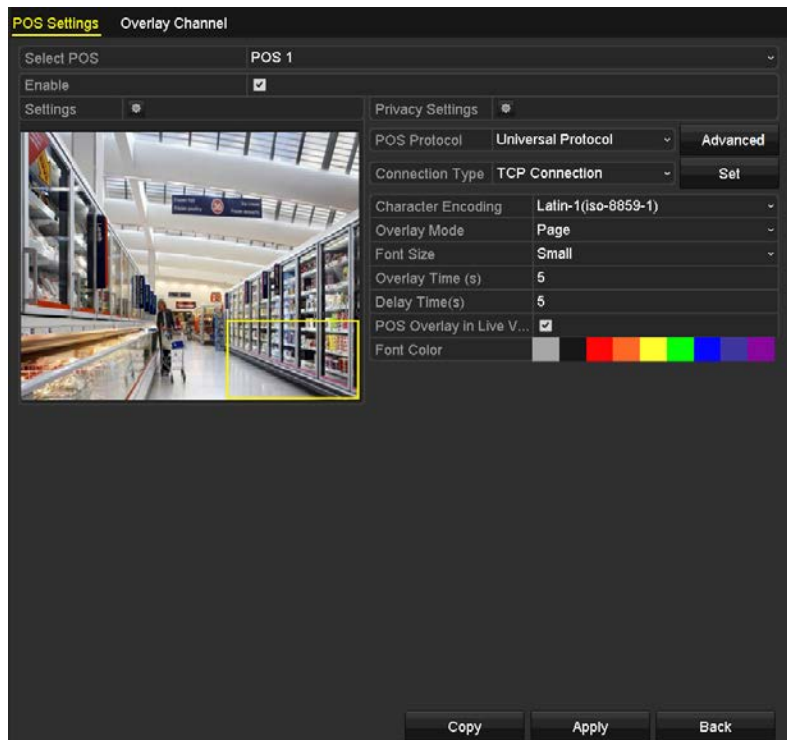



Figure 1-1 POS Settings

4. Filter the POS privacy information if needed.
  - 1) Click  after **Privacy Settings** to enter POS Privacy Information Filtering interface.

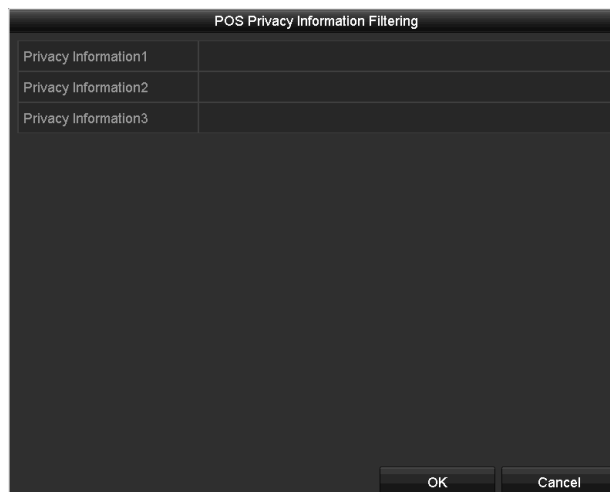

Figure 1-2 POS Privacy Information Filtering

- 2) Edit the Privacy Information in the text filed to hide the input information overlay. Up to 3 pieces of privacy information can be edited and no more than 32 characters can be input for each piece of information.
- 3) Click OK to save the settings.
- 4) Select the POS protocol to Universal Protocol, EPSON, AVE, or NUCLEUS.

- **Universal Protocol**

Click the **Advanced** button to expand more settings when selecting the universal protocol. You can set the start line tag, line break tag and end line tag for the POS overlay characters, and the case-sensitive property of the characters.

POS Protocol	Universal Protocol	General	
Connection Type	TCP Connection	Set	
Start Line Tag	a1	Hex	<input type="checkbox"/>
Line Break Tag	0D0A	Hex	<input checked="" type="checkbox"/>
End Line Tag	c1	Hex	<input type="checkbox"/>
Case-sensitive	<input checked="" type="checkbox"/>	No Tag	<input type="checkbox"/>

Figure 1-3 Universal Protocol Settings

- **NUCLEUS**

If you select NUCLEUS protocol, reboot the device to take the new settings into effect.

POS Protocol	NUCLEUS	Set
Connection Type	RS-232	Set

Figure 1-4 NUCLEUS Protocol Settings

- 1) Click **Set** button to enter the NUCLEUS Settings interface.

NUCLEUS Settings

e<employee#>

s<shift#>

t<terminal#>

OK Cancel

Figure 1-5 NUCLEUS Settings

- 2) Edit the Employee, Shift and Terminal information. No more than 32 characters can be input.
- 3) Click **OK** to save the settings.

**NOTE:** If you select NUCLEUS protocol, the connection type defaults to RS-232 and all the other POS protocol settings will change to NUCLEUS.

You should set Usage to be Transparent Channel for RS-232 settings in Menu > Configuration > RS-232 first.

- 4) Select the Connection Type as TCP, UDP, Multicast, RS-232, USB -> RS-232 or Sniff, and click **Set** to configure the parameters for each connection type.

- **TCP Connection**

When using TCP connection, the port must be set from 0 to 65535, and the port for each POS machine must be unique. Input the Allowed Remote IP Address for connecting the DVR and the POS machine via TCP.

TCP Connection Settings	
Port	10010
Allowed Remote IP Address	192 .0 .0 .64

Figure 1-6 TCP Connection Settings

- **UDP Connection**

When using UDP connection, the port must be set from 0 to 65535, and the port for each POS machine must be unique. Input the Allowed Remote IP Address for connecting the DVR and the POS machine via UDP.

UDP Connection Settings	
Port	10100
Allowed Remote IP Address	192 .0 .0 .64

Figure 1-7 UDP Connection Settings

- **USB -> RS-232 Connection**

Configure the port parameters of USB-to-RS-232 convertor, including the serial number of port, baud rate, data bit, stop bit, parity and flow ctrl.

**NOTE:** When using USB -> RS-232 convertor mode, the USB-to-RS-232 convertor port and the POS port must correspond to each other, e.g., POS1 must be connected to port1 of the convertor.



Figure 1-8 USB-to-RS-232 Settings

- **RS-232 Connection**

Connect the DVR and the POS machine via RS-232. The RS-232 settings can be configured in Menu > System Configuration > RS-232. The Usage must be set to Transparent Channel.



Figure 1-9 RS-232 Settings

- **Multicast Connection**

When connecting the DVR and the POS machine via Multicast protocol, set the multicast address and port.

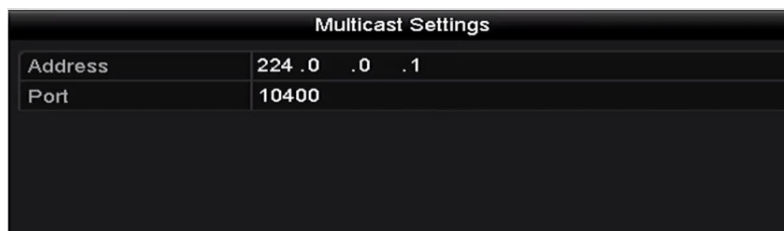

Figure 1-10 Multicast Settings

- **Sniff Connection**

Connect the DVR and the POS machine via Sniff. Configure the source address and destination address settings.

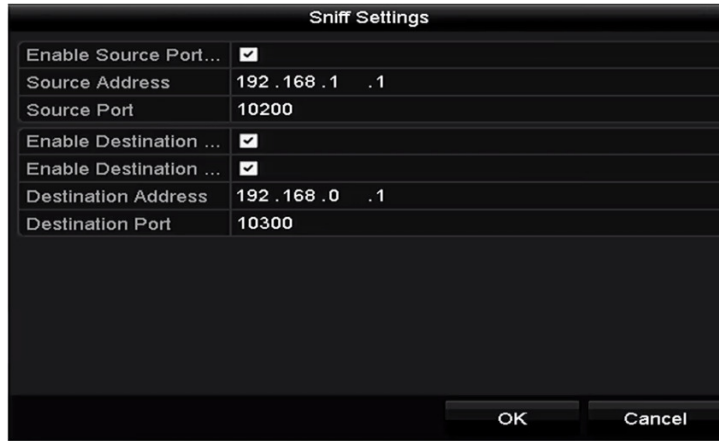

Figure 1-11 Sniff Settings

5. Set other parameters of characters overlay.
  - 1) Select the character encoding format from the drop-down list.
  - 2) Select the overlay mode of the characters to display in scrolling or page mode.
  - 3) Select the font size to small, medium or large.
  - 4) Set the overlay time of the characters. The value ranges from 5 to 3600 sec.
  - 5) Set the delay time of the characters. The value ranges from 5 to 3600 sec.
  - 6) (Optional) Check the checkbox to enable the POS Overlay in Live View.
  - 7) Select the font color for the characters.

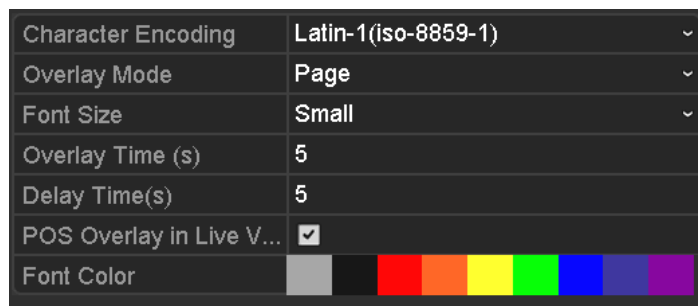

Figure 1-12 Overlay Character Settings

**NOTE:** You can adjust the size and position of textbox on the live view screen of POS settings interface by dragging the frame.

- 8) Click Apply to activate the settings.
- 9) (Optional) You can click the Copy button to copy the current settings to other POS(s).



Figure 1-13 Copy POS Settings

## 19.2. Configuring Overlay Channel

You can assign the POS machine to corresponding channel on which you want to overlay.

1. Enter the Overlay Channel interface, Menu > Configuration > POS > Overlay Channel.
2. Click to select an analog or IP camera from the camera list on the right, and then click a POS item from the POS list you want to overlay on the selected camera.
3. Click or to go to the previous or next page of cameras.



Figure 1-14 Overlay Channel Settings

4. You can also click to overlay all POS items to the first 8 channels in order. The is used to clear all POS overlay settings.
5. Click the **Apply** button to save the settings.

## 19.3. Configuring POS Alarm

Set the POS alarm parameters to trigger certain channels to start recording, or trigger full screen monitoring, audio warning, notifying the surveillance center, sending email and so on.

1. Enter the POS Settings interface, Menu > Configuration > POS > POS Settings.
2. Follow the steps in Chapter 9.1-9.2 to configure the POS settings.
3. Click  to enter the alarm settings interface.



Figure 1-15 Set Trigger Cameras of POS

4. Click Trigger Channel tab and select one or more channels to record or become full-screen monitoring when POS alarm is triggered.
5. Set arming schedule of the channel.
  - 1) Select Arming Schedule tab to set the channel's arming schedule.
  - 2) Choose one day of a week and up to eight time periods can be set within each day, or you can click the **Copy** button to copy the time period settings to other day(s).

**NOTE:** Time periods shall not be repeated or overlapped.

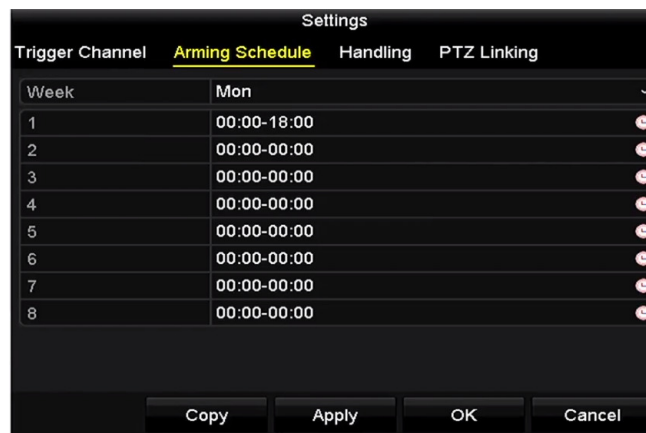

Figure 1-16 Set Arming Schedule

- 3) Click the Handling tab to set up alarm response actions of POS alarm (Refer to Chapter 15.7 Setting Alarm Response Actions).
- 4) Repeat the above steps to set up arming schedule of other days of a week.
- 5) Click the OK button to complete the POS settings of the channel.

6. Select PTZ Linking tab and set PTZ linkage of the POS alarm.

1) Set PTZ linking parameters and click the **OK** button to complete the settings of the alarm input.

**NOTE:** Check whether the PTZ or speed dome supports PTZ linkage.

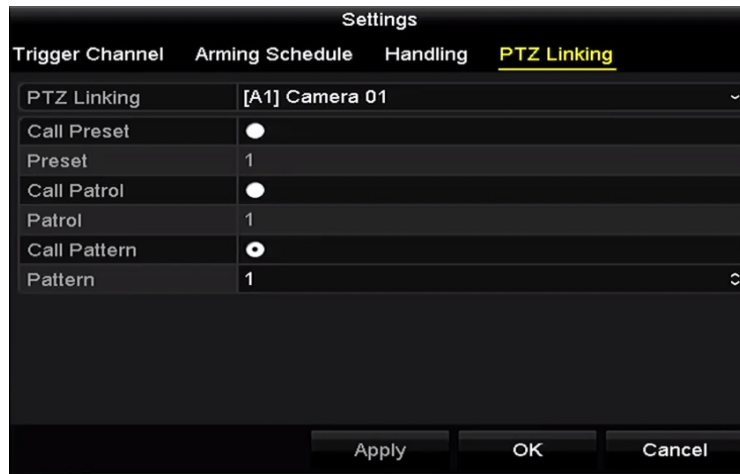

Figure 1-17 Set PTZ Linking

1) Click OK to save the settings.



## 20. Camera Settings

### 20.1. Configuring OSD Settings

Configure the OSD (On-Screen Display) settings for the camera, including date/time, camera name, etc.

1. Enter the OSD Configuration interface, Menu > Camera > OSD.
2. Select the camera to configure OSD settings.
3. Edit the Camera Name in the text field.
4. Configure the Display Name, Display Date, and Display Week by checking the checkbox.
5. Select the Date Format, Time Format, Display Mode, and the OSD Font.

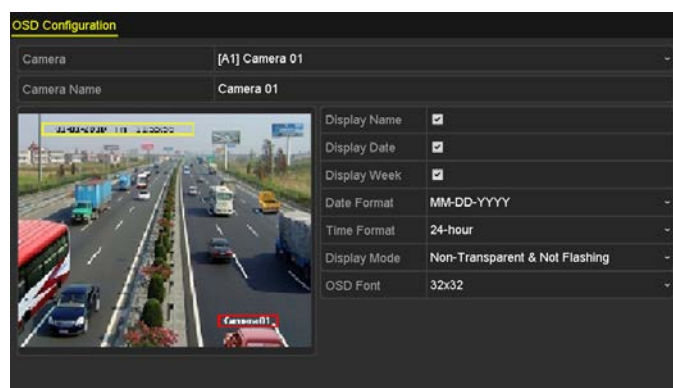

Figure 215, OSD Configuration Interface

6. Use the mouse to drag the text frame on the preview window to adjust the OSD position.
7. Copy the Camera Settings.
8. To copy the OSD settings of the current camera to other cameras, click the Copy button to enter the Copy Camera interface.

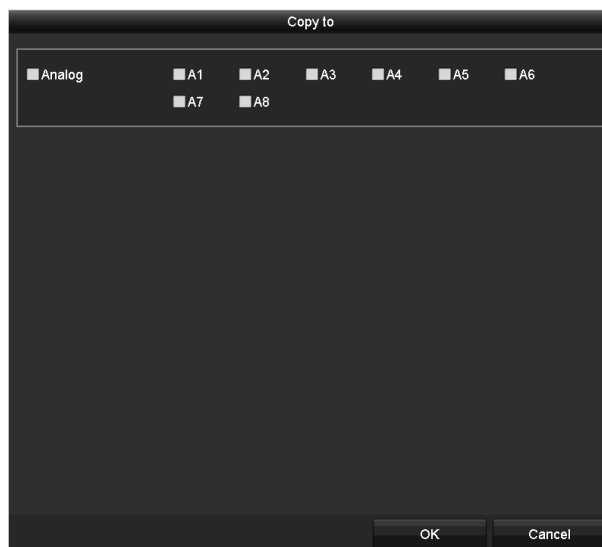

Figure 216, Copy Settings to Other Cameras

9. Select the camera(s) to be configured with the same OSD settings. You can also check the Analog checkbox to select all cameras.
10. Click the OK button to finish the Copy settings and go back to the OSD Configuration interface.
11. Click the Apply button to apply the settings.

## 20.2. Configuring Privacy Mask

You can configure four-sided privacy mask zones that cannot be viewed or recorded by the operator.

1. Enter the Privacy Mask Settings interface, Menu > Camera > Privacy Mask.
2. Select the camera to set privacy mask.
3. Check the Enable Privacy Mask checkbox to enable this feature.



Figure 217, Privacy Mask Settings Interface

4. Use the mouse to draw a zone on the window. The zones will be marked with different frame colors.

**NOTE:** Up to four privacy mask zones can be configured, and the size of each area can be adjusted.

5. The configured privacy mask zones on the window can be cleared by clicking the corresponding Clear Zone 1-4 icons on the right side of the window, or click Clear All to clear all zones.

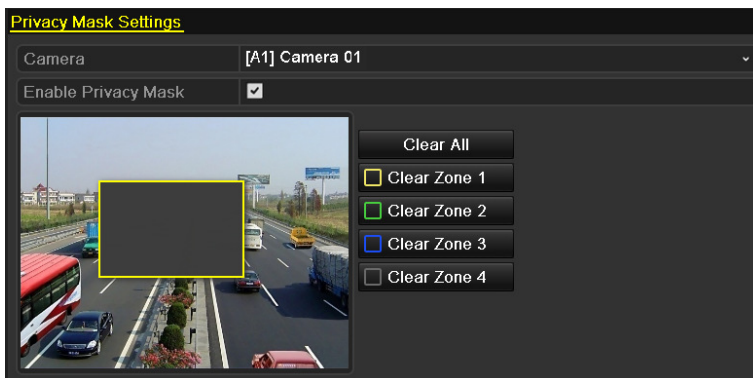

Figure 218, Set Privacy Mask Area

6. Click the Copy button to copy the privacy mask settings of the current camera to other cameras.
7. Click the Apply button to save the settings.

## 20.3. Configuring Video Parameters

### 20.3.1. Configuring Image Settings

1. Enter the Image Settings interface, Menu > Camera > Image.
2. Select the Image Settings tab.

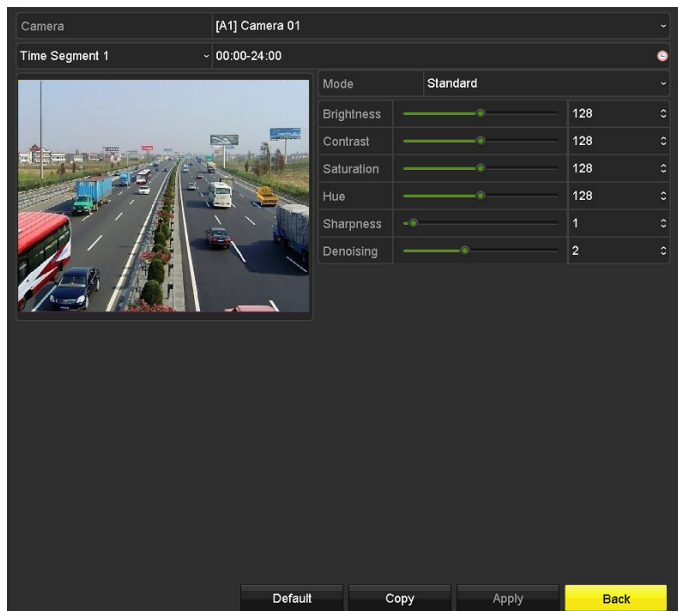

Figure 219, Image Settings Interface (Analog Camera)



Figure 220, Image Settings Interface (IP Camera)

3. Select the camera to set image parameters.
4. Two periods for different image settings are provided, select a period name in the drop-down list.

**NOTE:** Time periods cannot overlap.

5. Select the mode from the Mode drop-down list, there are four modes selectable: Standard, Indoor, Dim Light, and Outdoor.
6. Adjust the image parameters according to actual needs. Parameters include Brightness, Contrast, Saturation, Hue, Sharpness, and Denoising. Click Restore to set the default settings.

- 
7. You can click Copy to copy the image settings of the current camera to other cameras.
  8. Click Apply to save the settings.

### 20.3.2. Configuring Camera Parameters Settings

1. Enter the Image Settings interface, Menu > Camera > Image.
2. Select the Camera Parameters Settings tab.



Figure 221, Camera Parameters Settings

3. Select a camera from the drop-down list.
4. Adjust the camera parameters. The parameters include Day to Night Sensitivity, Night to Day Sensitivity, and IR Light Brightness. You can also click Default to reset the parameters to the default settings.
5. Click Copy to copy the parameters of the current camera to other cameras.
6. Click Apply to save the settings.

**NOTE:** Day to Night Sensitivity, Night to Day Sensitivity, and IR Light Brightness functions must be supported by the connected camera. You cannot set the parameters if the connected camera does not support them or there is no video signal.

The parameters are saved to the connected camera and are not saved to the DVR.

The default value of Day to Night Sensitivity, Night to Day Sensitivity, and IR Light Brightness is 5. The effective value ranges from 1 to 9.

If you exit from the interface and enter it again, the parameters displayed are those you previously set.

---

The DVR connects to the camera via the Coaxitron protocol and there is no response mechanism. Even if the Coaxitron connection is abnormal, the parameters are still displayed to be set successfully.

## 21. DVR Management and Maintenance

### 21.1. Viewing System Information

1. Enter the System Information interface, Menu > Maintenance > System Info.
2. Click the Device Info, Camera, Record, Network, and HDD tabs to view the device's system information.

Device Name	Embedded Net DVR
Model	DS-9016HUHI-F8/N
Serial No.	1620160516CCWR583574624WCVU
Firmware Version	V3.4.80, Build 160827
Hardware Version	0x81d00

Please scan the QR code via iVMS client.



Figure 222, System Information Interface

**NOTE:** You can view the hardware version in the Device Information interface.

### 21.2. Searching Log Files

The operation, alarm, exception, and information of the DVR can be stored in log files, which can be viewed and exported at any time.

1. Enter the Log Search interface, Menu > Maintenance > Log Information.

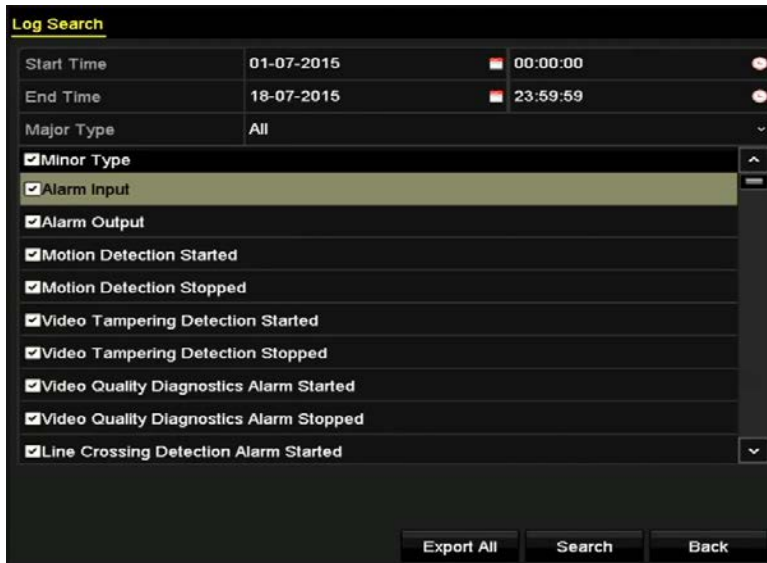

Figure 223, Log Search Interface

2. Set the log search conditions to refine your search, including the Start Time, End Time, Major Type, and Minor Type.
3. Click the Search button to start searching log files.
4. Matching log files will be listed.

**NOTE:** Up to 2,000 log files can be displayed each time.

No.	Major Type	Time	Minor Type	Parameter	Play	Details
1	Information	10-07-2015 09:53:59	Local HDD Infor...	N/A	—	✓
2	Operation	10-07-2015 09:53:59	Power On	N/A	—	✓
3	Information	10-07-2015 09:54:05	Start Recording	N/A	⏮	✓
4	Operation	10-07-2015 09:54:08	Local Operation:...	N/A	—	✓
5	Information	10-07-2015 09:54:25	HDD S.M.A.R.T.	N/A	—	✓
6	Information	10-07-2015 09:54:32	Start Recording	N/A	⏮	✓
7	Operation	10-07-2015 09:54:32	Local Operation:...	N/A	⏮	✓
8	Operation	10-07-2015 09:54:32	Local Operation:...	N/A	⏮	✓
9	Exception	10-07-2015 09:55:32	IP Camera Disco...	N/A	⏮	✓
10	Information	10-07-2015 10:04:09	System Running...	N/A	—	✓

Total: 2000 P: 1/20

Figure 224, Log Search Results

5. Click the button of each log or double-click it to view its detailed information. You can also click the button to view the related video files if available.

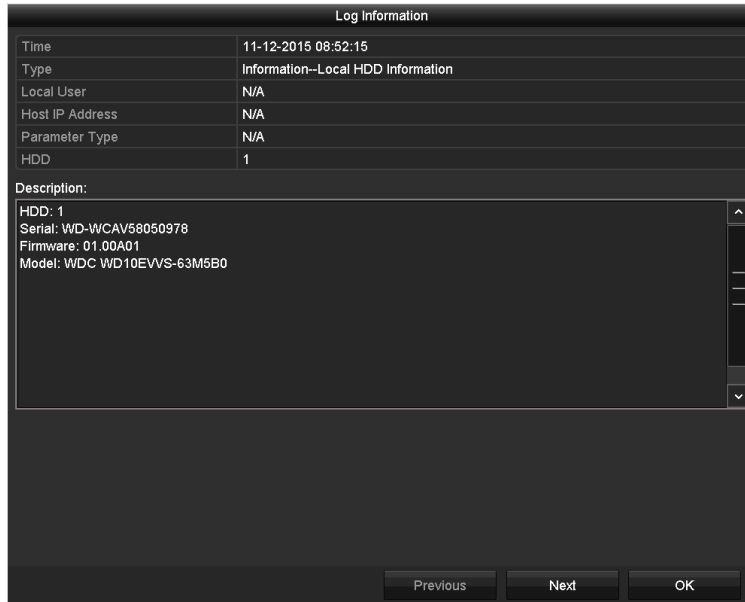

Figure 225, Log Information Interface

- To export the log files, click the Export button to enter the Export menu.



Figure 226, Export Log Files

- Select the backup device from the Device Name drop-down list.
- Click the Export button to export the log files to the selected backup device.
- Click the New Folder button to create a new folder in the backup device, or click the Format button to format the backup device before log export.

**NOTE:** Connect the backup device to the DVR before operating log export.

The log files exported to the backup device are named using the export time, e.g., *20110514124841logBack.txt*.



## 21.3. Importing/Exporting Configuration Files

### 21.3.1. Purpose

The DVR configuration files can be exported to a local device for backup, and the configuration files of one DVR can be imported to multiple DVR devices if they are to be configured with the same parameters.

1. Enter the Import/Export Configuration File interface, Menu > Maintenance > Import/Export.

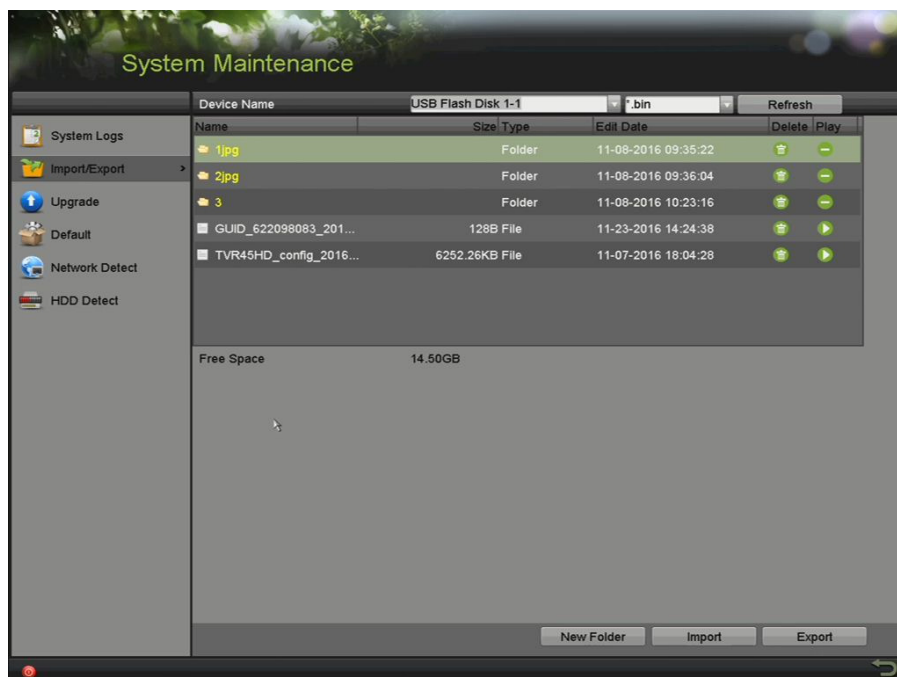

Figure 227, Import/Export Configuration File

2. Click the Export button to export the configuration files to the selected local backup device.
3. To import a configuration file, select the file from the selected backup device and click the Import button.
4. After the import process has completed, the device will reboot automatically.

## 21.4. Upgrading System

The DVR firmware can be upgraded by a local backup device or remote FTP server.

### 21.4.1. Upgrading by Local Backup Device

1. Connect your DVR to a local backup device where the update firmware file is located.
2. Enter the Upgrade interface, Menu > Maintenance > Upgrade.
3. Click the Local Upgrade tab to enter the Local Upgrade interface.

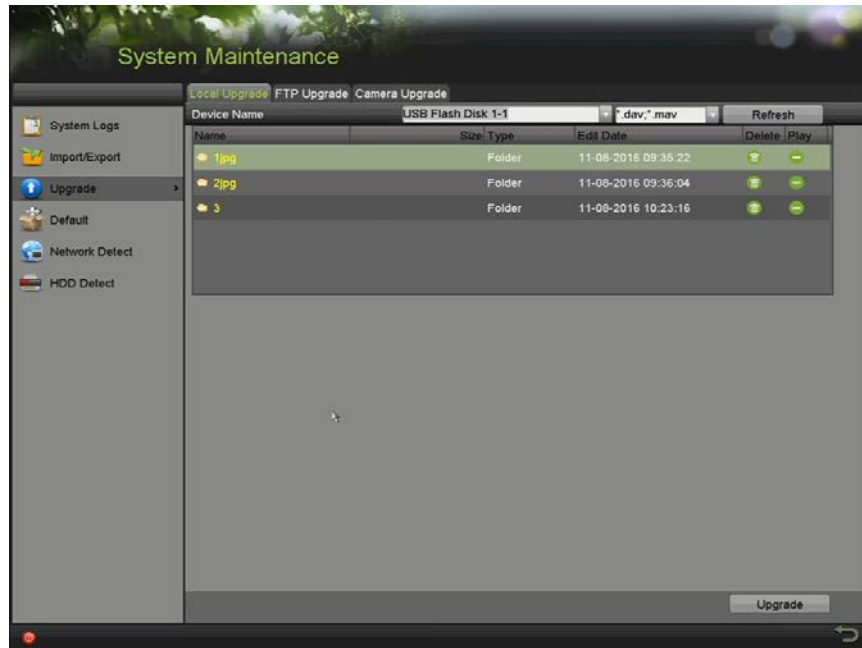

Figure 228, Local Upgrade Interface

4. Select the update file from the backup device.
5. Click the Upgrade button to start upgrading.
6. After the upgrading is complete, reboot the DVR to activate the new firmware.

#### 21.4.2. Upgrading by FTP

1. Configure PC (running FTP server) and DVR to the same Local Area Network. Run the third-party TFTP software on the PC and copy the firmware into the TFTP root directory.
2. Enter the Upgrade interface, Menu > Maintenance > Upgrade.
3. Click the FTP tab to enter the Local Upgrade interface.

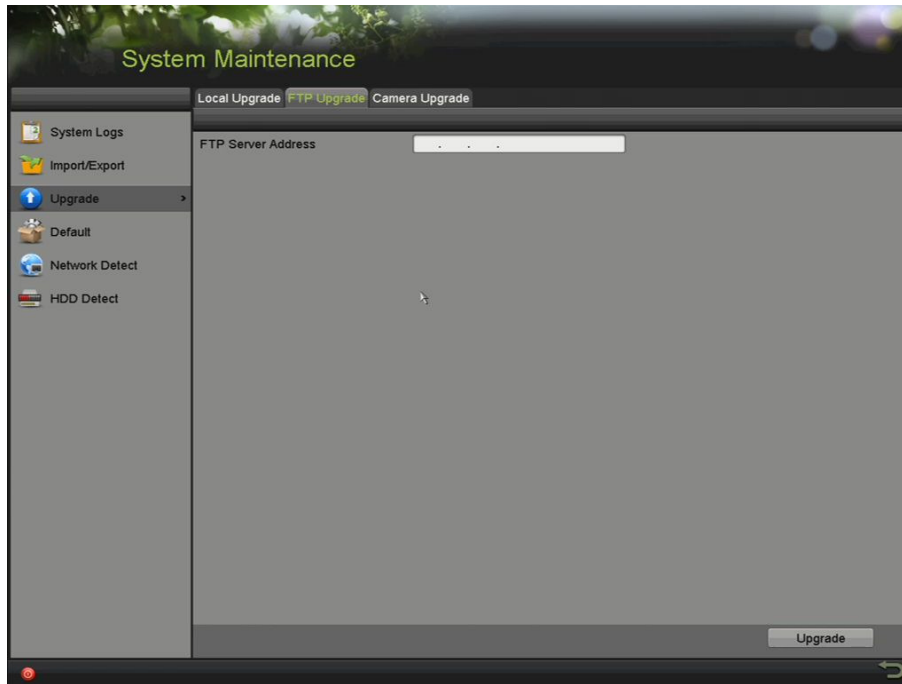

Figure 229, FTP Upgrade Interface

4. Enter the FTP Server Address in the text field.
5. Click the Upgrade button to start upgrading.
6. After the upgrading is complete, reboot the DVR to activate the new firmware.

## 21.5. Restoring Default Settings

1. Enter the Default interface, Menu > Maintenance > Default.

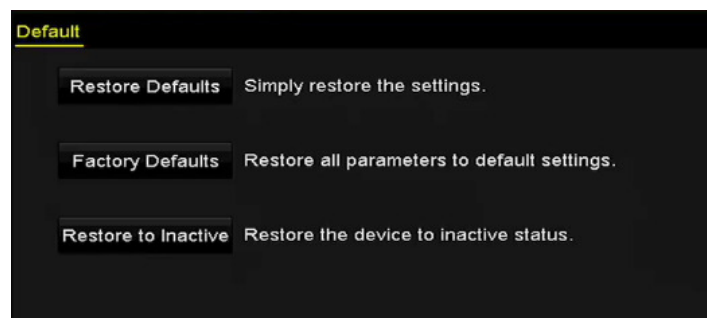

Figure 230, Restore Defaults

2. Select the restoring type from the following three options.
  - **Restore Defaults:** Restore all parameters, except the network (including IP address, subnet mask, gateway, MTU, NIC working mode, default route, server port, etc.) and user account parameters, to the factory default settings.
  - **Factory Defaults:** Restore all parameters to the factory default settings.
  - **Restore to Inactive:** Restore the device to inactive status.

3. Click the OK button to restore the default settings.

**NOTE:** The device will reboot automatically after restoring to the default settings.

## 21.6. Configuring General Settings

You can configure the output resolution, system time, mouse pointer speed, etc.

1. Enter the General Settings interface, Menu > Configuration > General.
2. Select the General tab.

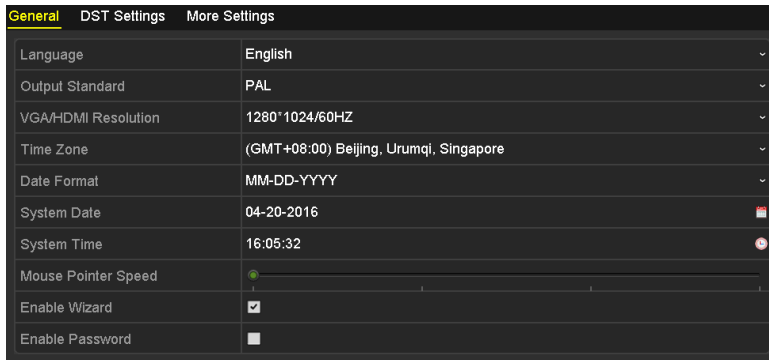

Figure 231, General Settings Interface for Simultaneous VGA and HDMI Output

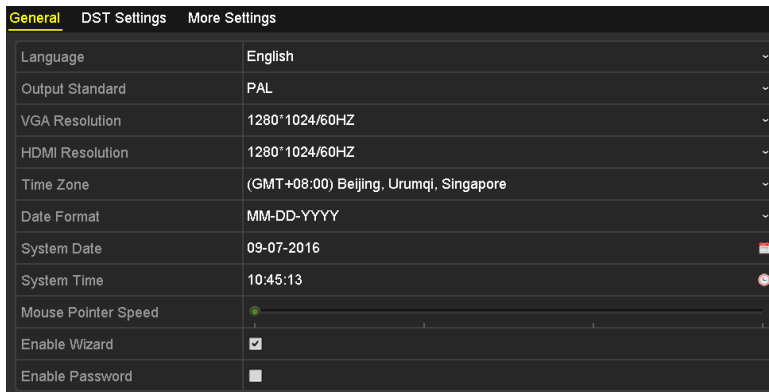

Figure 232, General Settings Interface for Independent VGA and HDMI Output

3. Configure the following settings:
  - **Language:** The default language used is *English*.
  - **Output Standard:** Select the output standard to be PAL or NTSC.
  - **VGA/HDMI Resolution:** Select the output resolution, which must be the same as the VGA/HDMI display resolution.
  - **Time Zone:** Select the time zone.
  - **Date Format:** Select the date format.
  - **System Date:** Select the system date.

- **System Time:** Select the system time.
- **Mouse Pointer Speed:** Set the mouse pointer speed, four levels are configurable.
- **Enable Wizard:** Enable/disable the Wizard when the device starts up.
- **Enable Password:** Enable/disable the use of the login password.

**NOTE:** If you check the Enable Password checkbox, everytime you log in to the DVR, the Unlock Pattern interface will pop up. If you uncheck the Enable Password checkbox, the Unlock Pattern interface will not pop up when you log in to the DVR.

4. Click the Apply button to save the settings.

## 21.7. Configuring DST Settings

1. Enter the General Settings interface, Menu > Configuration > General.
2. Select the DST Settings tab.



Figure 233, DST Settings Interface

3. Check the Auto DST Adjustment checkbox, or manually check the Enable DST checkbox, and then choose the DST period date.

## 21.8. Configuring More Settings

1. Enter the General Settings interface, Menu > Configuration > General.
2. Click the More Settings tab to enter the More Settings interface.



Figure 234, More Settings Interface (1)

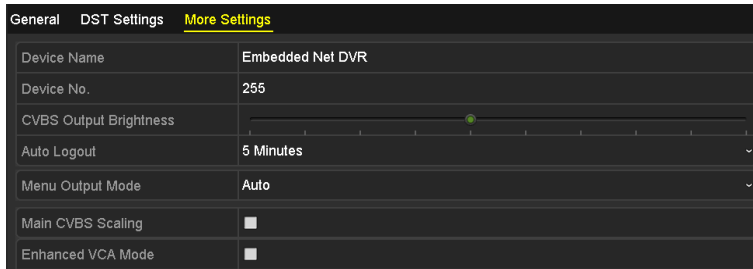

Figure 235, More Settings Interface (2)

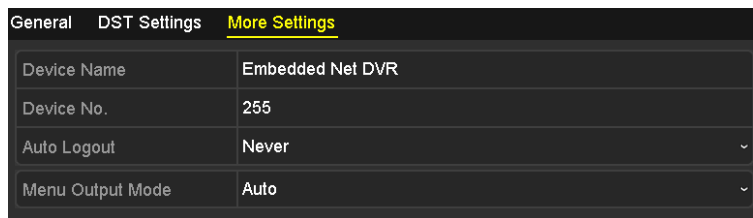

Figure 236, More Settings Interface (3)

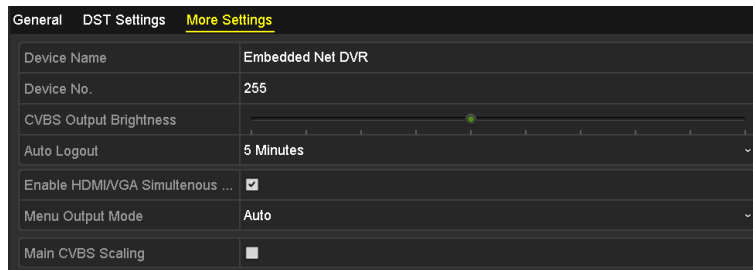

Figure 237, More Settings Interface (4)

3. Configure the following settings:

- **Device Name:** Edit the DVR name.
- **Device No.:** Edit the DVR serial number. The Device No. can be set in the range of 1 to 255 (default is 255).
- **Auto Logout:** Set menu inactivity timeout time (e.g., when the timeout time is set to *5 Minutes*, the system will exit from the current operation menu to the Live View screen after 5 minutes of menu inactivity).
- **Menu Output Mode:** Choose the menu display on different video output.
- **Auto** and **HDMI/VGA** are selectable

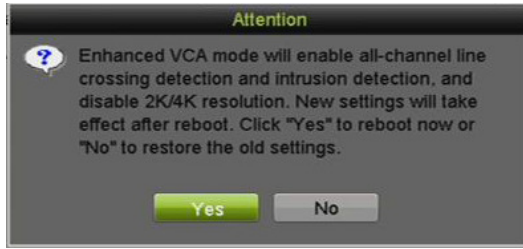

Figure 238, Enable Enhanced VCA Mode

4. If enhanced VCA mode has been enabled, you can disable it by unchecking the checkbox. When you disable it and click Apply, an attention box pops up. Click Yes to apply the function and reboot the device.

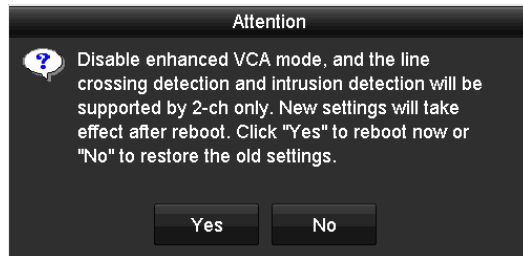

Figure 239, Disable Enhanced VCA Mode

5. Click the Apply button to save the settings.

## 21.9. Managing User Accounts

There is a default account in the DVR: *Administrator*. The *Administrator* user name is *admin* and the password is set when you start the device for the first time. The *Administrator* has the permission to add and delete users and configure user parameters.

### 21.9.1. Adding a User

1. Enter the User Management interface, Menu > Configuration > User.

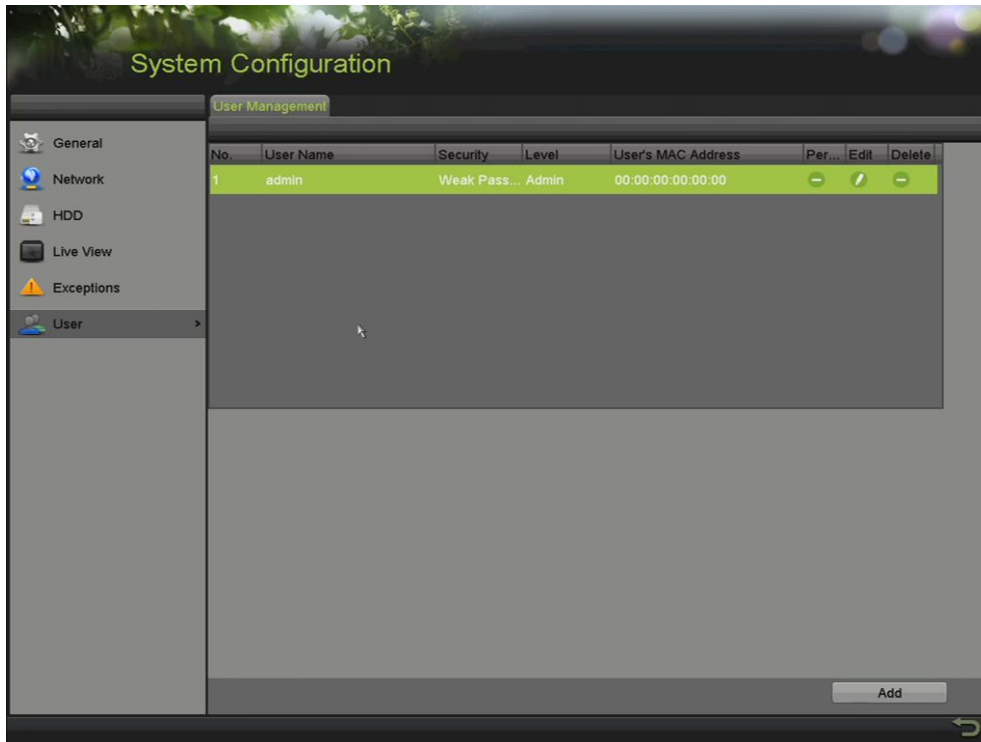

Figure 240, User Management Interface

2. Click the Add button to enter the Add User interface.

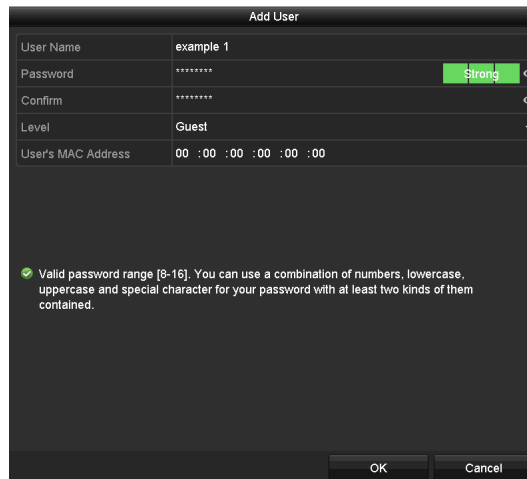

Figure 241, Add User Menu

3. Enter the information for a new user, including User Name, Password, Confirm, Level, and User's MAC Address.
4. **Password:** Set the password for the user account.





## WARNING

**STRONG PASSWORD RECOMMENDED** – We highly recommend you create a strong password of your own choosing (using a minimum of 8 characters, including at least three of the following categories: upper case letters, lower case letters, numbers, and special characters) in order to increase the security of your product. We also recommend you reset your password regularly. Especially in high security systems, resetting the password monthly or weekly can better protect your product.

5. **Level:** Set the user level to Operator or Guest. Different user levels have different operating permission.
  - **Operator:** The *Operator* user level has Two-way Audio in Remote Configuration permission and all operating permissions in Camera Configuration by default.
  - **Guest:** The *Guest* user has no Two-way Audio in Remote Configuration permission and has only local/remote playback in the Camera Configuration by default.
  - **User's MAC Address:** The MAC address of the remote PC that logs onto the DVR. If it is configured and enabled, it allows only the remote user with this MAC address to access the DVR.
6. Click the OK button to save the settings and go back to the User Management interface. The added new user will be displayed on the list.

No.	User Name	Security	Level	User's MAC Address	Per...	Edit	Delete
1	admin	Strong Pas...	Admin	00:00:00:00:00:00	-		-
2	example 1	Strong Pas...	Guest	00:00:00:00:00:00			

Figure 242, Added User Listed in User Management Interface

7. Select the user from the list and then click to enter the Permission Settings interface.

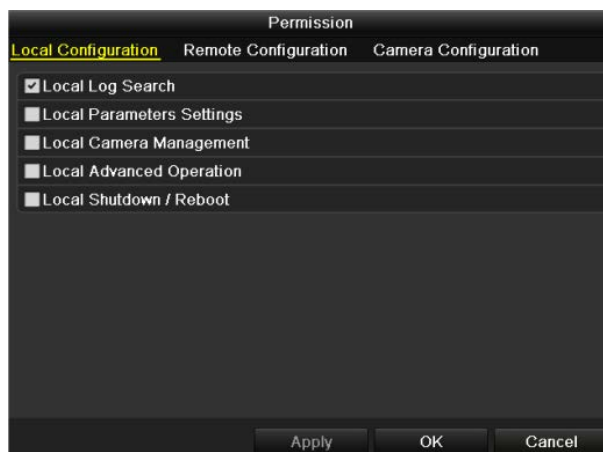

---

Figure 243, User Permission Settings Interface

8. Set the user operating permission for Local Configuration, Remote Configuration, and Camera Configuration.
  - Local Configuration
    - Local Log Search: Searching and viewing logs and system information of device.
    - Local Parameters Settings: Configuring parameters, restoring factory default parameters, and importing/exporting configuration files.
    - Local Advanced Operation: Operating HDD management (initializing HDD, setting HDD property), upgrading system firmware.
    - Local Shutdown/Reboot: Shutting down or rebooting the device.
  - Remote Configuration
    - Remote Log Search: Remotely viewing logs that are saved on the device.
    - Remote Parameters Settings: Remotely configuring parameters, restoring factory default parameters, and importing/exporting configuration files.
    - Remote Serial Port Control: Configuring settings for RS-485 port.
    - Remote Video Output Control: Sending remote control panel signal.
    - Two-way Audio: Realizing two-way radio between the remote client and the device.
    - Remote Alarm Control: Remotely arming (notify alarm and exception message to the remote client) and controlling the alarm output.
    - Remote Advanced Operation: Remotely operating HDD management (initializing HDD, setting HDD property), upgrading system firmware.
    - Remote Shutdown/Reboot: Remotely shutting down or rebooting the device.
  - Camera Configuration
    - Remote Live View: Remotely viewing live video of the selected camera(s)
    - Remote Manual Operation: Remotely starting/stopping manual recording and alarm output of the selected camera(s).
    - Local Playback: Locally playing back recorded files of the selected camera(s)
    - Remote Playback: Remotely playing back recorded files of the selected camera(s)
    - Local PTZ Control: Locally controlling PTZ movement of the selected camera(s)
    - Remote PTZ Control: Remotely controlling PTZ movement of the selected camera(s)
    - Local Video Export: Locally exporting recorded files of the selected camera(s)
9. Click OK to save the settings and exit.

## 21.9.2. Deleting a User

1. Enter the User Management interface, Menu > Configuration > User.
2. Select the user to be deleted from the list.

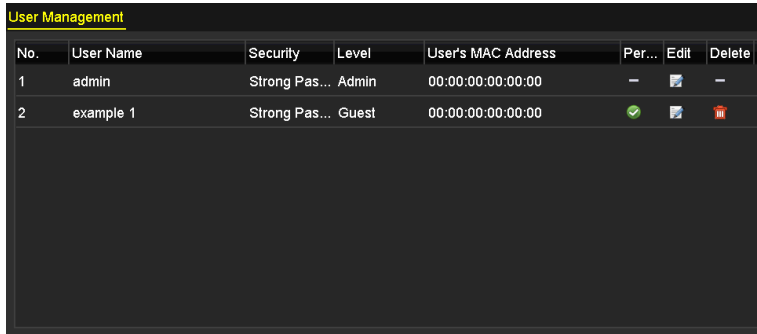

No.	User Name	Security	Level	User's MAC Address	Per...	Edit	Delete
1	admin	Strong Pas...	Admin	00:00:00:00:00:00	-		
2	example 1	Strong Pas...	Guest	00:00:00:00:00:00			

Figure 244, User List

3. Click  to delete the selected user account.

## 21.9.3. Editing a User

For the added user accounts, you can edit the parameters.

1. Enter the User Management interface, Menu > Configuration > User.
2. Select the user to be edited from the list.
3. Click the  icon to enter the Edit User interface.

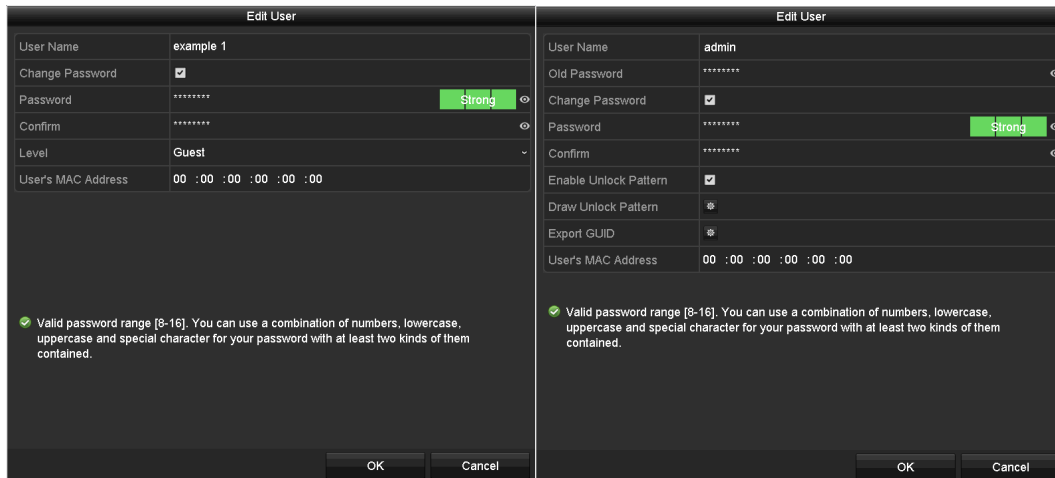

The figure shows two side-by-side screenshots of the 'Edit User' interface. The left screenshot shows the user 'example 1' with level 'Guest'. The right screenshot shows the user 'admin' with level 'Admin'. Both screens have a 'Change Password' checkbox checked and a password strength indicator showing 'Strong'. The 'User's MAC Address' is displayed as '00 : 00 : 00 : 00 : 00 : 00'. A green checkmark and a message at the bottom of each screen indicate that the password is valid and meets the requirements (8-16 characters, including numbers, lowercase, uppercase, and special characters).

Figure 245, Edit User Interface

4. Edit the corresponding parameters.
  - Operator and Guest

You can edit the user information, including user name, password, permission level, and MAC address. Check the Change Password checkbox if you want to change the password, and input the new password in the Password text field and Confirm. A strong password is recommended.

- Admin

You are allowed only to edit the password and MAC address. Check the Change Password checkbox if you want to change the password, and input the correct old password, and the new password in the Password and Confirm text fields.



**STRONG PASSWORD RECOMMENDED** – We highly recommend you create a strong password of your own choosing (using a minimum of 8 characters, including at least three of the following categories: upper case letters, lower case letters, numbers, and special characters.) in order to increase the security of your product. We also recommend you reset your password regularly. Especially in a high security system, resetting the password monthly or weekly can better protect your product.

**NOTE:** Hold the  icon to show the password. Release the mouse to hide the password.

5. Check the checkbox of Enable Unlock Pattern to enable the use of unlock pattern when logging in to the device.
6. Use the mouse to draw a pattern among the nine dots on the screen. Release the mouse when the pattern is done.
7. Confirm the pattern again with the mouse.

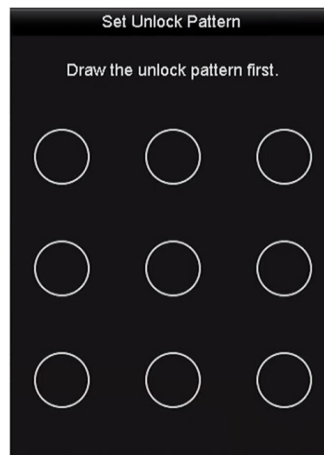



Figure 246, Set Unlock Pattern for Admin User

8. (Optional) Click the  icon after completing the Draw Unlock Pattern to modify the pattern.
9. (Optional) Click the  icon after clicking Export GUID to pop up the Reset Password interface. Click the Export button to export the GUID password reset file to the USB flash disk for retrieving a forgotten password. The GUID file will be saved to the USB flash disk.

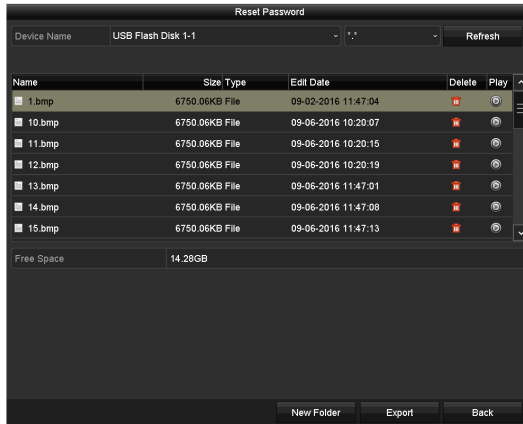



Figure 247, Export GUID File

**NOTE:** You must input the correct old password of the *admin* before exporting the GUID file.

10. Click the OK button to save the settings and exit from the menu.
11. (Optional) For an Operator or Guest user account, you can also click the  button on the User Management interface to edit the permission.

---

## 22. Appendix

### 22.1. Glossary

- **Dual-Stream.** A technology used to record high resolution video locally while transmitting a lower resolution stream over the network. The two streams are generated by the DVR, with the main stream having a maximum resolution of 1080p and the sub-stream having a maximum resolution of CIF.
- **DVR (Digital Video Recorder).** A device that is able to accept video signals from analog cameras, compress the signal and store it on its hard drives.
- **HDD (Hard Disk Drive).** A storage medium that stores digitally encoded data on platters with magnetic surfaces.
- **DHCP (Dynamic Host Configuration Protocol).** A network application protocol used by devices (DHCP clients) to obtain configuration information for operation in an Internet Protocol network.
- **HTTP (Hypertext Transfer Protocol).** A protocol to transfer hypertext request and information between servers and browsers over a network
- **PPPoE (Point-to-Point Protocol over Ethernet).** A network protocol for encapsulating Point-to-Point Protocol (PPP) frames inside Ethernet frames. It is used mainly with ADSL services where individual users connect to the ADSL transceiver (modem) over Ethernet and in plain Metro Ethernet networks.
- **DDNS: Dynamic DNS** is a method, protocol, or network service that provides the capability for a networked device, such as a router or computer system using the Internet Protocol Suite, to notify a domain name server to change, in real time (ad-hoc) the active DNS configuration of its configured hostnames, addresses or other information stored in DNS.
- **Hybrid DVR:** A hybrid DVR is a combination of a DVR and NVR.
- **NTP (Network Time Protocol).** A protocol designed to synchronize computer clocks over a network.
- **NTSC (National Television System Committee).** An analog television standard used in such countries as the United States and Japan. Each frame of an NTSC signal contains 525 scan lines at 60 Hz.
- **NVR (Network Video Recorder).** An NVR can be a PC-based or embedded system used for centralized management and storage for IP cameras, IP Domes and other DVRs.
- **PAL (Phase Alternating Line).** PAL is also another video standard used in broadcast televisions systems in large parts of the world. PAL signal contains 625 scan lines at 50 Hz.
- **PTZ (Pan, Tilt, Zoom).** PTZ cameras are motor driven systems that allow the camera to pan left and right, tilt up and down and zoom in and out.
- **USB (Universal Serial Bus).** A plug-and-play serial bus standard to interface devices to a host computer.

---

## 22.2. Troubleshooting

- No image displayed on the monitor after the device is starting up normally.

Possible Reasons:

- No VGA or HDMI connections.
  - Connection cable is damaged.
  - Input mode of the monitor is incorrect.
1. Verify the device is connected to the monitor via HDMI or VGA cable. If not, connect the device to the monitor and reboot.
  2. Verify the connection cable is good.

If there is still no image displayed on the monitor after rebooting, check if the connection cable is good, and change the cable and connect again.

1. Check that the monitor input mode matches the output mode of the device (e.g., if the DVR output mode is HDMI output, then the monitor input mode must be HDMI input). If not, modify the monitor input mode.
2. Check if the fault is solved by step 1 to step 3.
3. If it is solved, finish the process. If not, contact Hikvision tech support.

- There is a beep sound after a new device starts up.

Possible Reasons:

- No HDD is installed in the device.
  - The installed HDD has not been initialized.
  - The installed HDD is not compatible with the device or is defective.
1. Verify at least one HDD is installed in the device.
  2. If not, please install a compatible HDD.

**NOTE:** If you do not want to install an HDD, select Menu > Configuration > Exceptions, and uncheck the HDD Error Audible Warning checkbox.

3. Verify the HDD is initialized.
4. Select Menu > HDD > General.
5. If the status of the HDD is Uninitialized, check the checkbox of the corresponding HDD and click the Init button.
6. Verify the HDD is detected and is in good condition.
7. Select "Menu>HDD>General".

- 
8. If the HDD is not detected or the status is Abnormal, replace the HDD according to the requirement.
  9. Check if the fault is solved.
  10. If it is solved, finish the process. If not, please contact Hikvision technical support.

- Live View image freezes when video outputs locally.

Possible Reasons:

- The frame rate has not reached the real-time frame rate.
1. Check the parameters of Main Stream (Continuous) and Main Stream (Event).
  2. Select Menu > Record > Parameters > Record, and set the resolution of Main Stream (Event) the same as the Main Stream (Continuous).
  3. Verify the frame rate is real-time frame rate.
  4. Select Menu > Record > Parameters > Record, and set the Frame Rate to Full Frame.
  5. Check if the fault is solved by the above steps.
  6. If it is solved, finish the process. If not, contact Hikvision Technical Support.
- When using the device to get Live View audio, there is no sound, there is too much noise, or the volume is too low.

Possible Reasons:

- Cable between the pickup and camera is not connected well; impedance mismatches or is incompatible.
  - The stream type is not set as Video & Audio.
1. Verify the cable between the pickup and camera is connected well; impedance matches and is compatible.
  2. Verify the setting parameters are correct.
  3. Select "Menu > Record > Parameters > Record", and set the Stream Type as "Audio & Video".
  4. Check if the fault is solved by the above steps.
  5. If it is solved, finish the process. If not, contact Hikvision Technical Support.xxxxxxxx
- The image freezes when DVR is playing back by single or multi-channel cameras.

Possible Reasons:

- The frame rate is not the real-time frame rate.
- The DVR supports up to 16-channel synchronize playback, depending on model, at the resolution of 4CIF. If you want a 16-channel synchronize playback at the resolution of 720p, frame extracting may occur, which leads to image freezing.



- 
1. Verify the frame rate is real-time frame rate.
  2. Select “Menu > Record > Parameters > Record”, and set the Frame Rate to “Full Frame”.
  3. Verify the hardware supports the playback.
  4. Reduce the channel number of playback.
  5. Select Menu > Record > Encoding > Record, and set the resolution and bitrate to a lower level.
  6. Reduce the number of local playback channels.
  7. Select Menu > Playback, and uncheck the checkboxes of unnecessary channels.
  8. Check if the fault is solved by the above steps.
  9. If it is solved, finish the process. If not, please contact Hikvision Technical Support.
- No record file found in the device’s local HDD, and the prompt “No record file found” pops up when searching the record files.

Possible Reasons:

- The time setting of system is incorrect.
  - The search condition is incorrect.
  - The HDD is error or not detected.
1. Select Menu > Configuration > General > General, and verify the System Time is correct.
  2. Verify the search condition is correct.
  3. Select Playback, and verify the channel and time are correct.
  4. Verify the HDD status is normal.
  5. Select Menu > HDD > General to view the HDD status, and verify the HDD is detected and can be read and written normally.
  6. Check if the fault is solved by the above steps.
  7. If it is solved, finish the process. If not, contact Hikvision Technical Support.



First Choice for Security Professionals



Hikvision USA Inc., 18639 Railroad Street, City of Industry, CA 91748, USA • Hikvision Canada, 4485 Dobrin, St-Laurent, Quebec, Canada, H4R 2L8  
Tel: +1-909-895-0400 • Toll Free in USA: +1-866-200-6690 • E-Mail: [sales.usa@hikvision.com](mailto:sales.usa@hikvision.com) • [www.hikvision.com](http://www.hikvision.com)  
© 2017 Hikvision USA Inc. • All Rights Reserved • Specifications subject to change without notice.

041717NA