



# Explosion-Proof Bullet Network Camera

Quick Start Guide

20200930

UD14888B



## **Quick Start Guide**

©2020 Hangzhou Hikvision Digital Technology Co., Ltd. All rights reserved.

This Manual is the property of Hangzhou Hikvision Digital Technology Co., Ltd. or its affiliates (hereinafter referred to as “Hikvision”), and it cannot be reproduced, changed, translated, or distributed, partially or wholly, by any means, without the prior written permission of Hikvision. Unless otherwise expressly stated herein, Hikvision does not make any warranties, guarantees or representations, express or implied, regarding to the Manual, any information contained herein.

### **About this Manual**

The Manual includes instructions for using and managing the Product. Pictures, charts, images and all other information hereinafter are for description and explanation only. The information contained in the Manual is subject to change, without notice, due to firmware updates or other reasons. Please find the latest version of this Manual at the Hikvision website (<https://www.hikvision.com/>).

Please use this Manual with the guidance and assistance of professionals trained in supporting the Product.

### **Trademarks Acknowledgement**

- **HIKVISION** and other Hikvision’s trademarks and logos are the properties of Hikvision in various jurisdictions.



- Other trademarks and logos mentioned are the properties of their respective owners.

## **LEGAL DISCLAIMER**

TO THE MAXIMUM EXTENT PERMITTED BY APPLICABLE LAW, THIS MANUAL AND THE PRODUCT DESCRIBED, WITH ITS HARDWARE, SOFTWARE AND FIRMWARE, ARE PROVIDED “AS IS” AND “WITH ALL FAULTS AND ERRORS”. HIKVISION MAKES NO WARRANTIES, EXPRESS OR IMPLIED, INCLUDING WITHOUT LIMITATION, MERCHANTABILITY, SATISFACTORY QUALITY, OR FITNESS FOR A PARTICULAR PURPOSE. THE USE OF THE PRODUCT BY YOU IS AT YOUR OWN RISK. IN NO EVENT WILL HIKVISION BE LIABLE TO YOU FOR ANY SPECIAL, CONSEQUENTIAL, INCIDENTAL, OR INDIRECT DAMAGES, INCLUDING, AMONG OTHERS, DAMAGES FOR LOSS OF BUSINESS PROFITS, BUSINESS INTERRUPTION, OR LOSS OF DATA, CORRUPTION OF SYSTEMS, OR LOSS OF DOCUMENTATION, WHETHER BASED ON BREACH OF CONTRACT, TORT (INCLUDING NEGLIGENCE), PRODUCT LIABILITY, OR OTHERWISE, IN CONNECTION WITH THE USE OF THE PRODUCT, EVEN IF HIKVISION HAS BEEN ADVISED OF THE POSSIBILITY OF SUCH DAMAGES OR LOSS.

YOU ACKNOWLEDGE THAT THE NATURE OF INTERNET PROVIDES FOR INHERENT SECURITY RISKS, AND HIKVISION SHALL NOT TAKE ANY RESPONSIBILITIES FOR ABNORMAL OPERATION, PRIVACY LEAKAGE OR OTHER DAMAGES RESULTING FROM CYBER-ATTACK, HACKER ATTACK, VIRUS INFECTION, OR OTHER INTERNET SECURITY RISKS; HOWEVER, HIKVISION WILL PROVIDE TIMELY TECHNICAL SUPPORT IF REQUIRED.



YOU AGREE TO USE THIS PRODUCT IN COMPLIANCE WITH ALL APPLICABLE LAWS, AND YOU ARE SOLELY RESPONSIBLE FOR ENSURING THAT YOUR USE CONFORMS TO THE APPLICABLE LAW. ESPECIALLY, YOU ARE RESPONSIBLE, FOR USING THIS PRODUCT IN A MANNER THAT DOES NOT INFRINGE ON THE RIGHTS OF THIRD PARTIES, INCLUDING WITHOUT LIMITATION, RIGHTS OF PUBLICITY, INTELLECTUAL PROPERTY RIGHTS, OR DATA PROTECTION AND OTHER PRIVACY RIGHTS. YOU SHALL NOT USE THIS PRODUCT FOR ANY PROHIBITED END-USES, INCLUDING THE DEVELOPMENT OR PRODUCTION OF WEAPONS OF MASS DESTRUCTION, THE DEVELOPMENT OR PRODUCTION OF CHEMICAL OR BIOLOGICAL WEAPONS, ANY ACTIVITIES IN THE CONTEXT RELATED TO ANY NUCLEAR EXPLOSIVE OR UNSAFE NUCLEAR FUEL-CYCLE, OR IN SUPPORT OF HUMAN RIGHTS ABUSES.

IN THE EVENT OF ANY CONFLICTS BETWEEN THIS MANUAL AND THE APPLICABLE LAW, THE LATER PREVAILS.

## Regulatory Information

### FCC Information

Please take attention that changes or modification not expressly approved by the party responsible for compliance could void the user's authority to operate the equipment.

**FCC compliance:** This equipment has been tested and found to comply with the limits for a Class A digital device, pursuant to part 15 of the FCC Rules. These limits are designed to provide reasonable protection against harmful interference when the equipment is operated in a commercial environment. This equipment generates,



uses, and can radiate radio frequency energy and, if not installed and used in accordance with the instruction manual, may cause harmful interference to radio communications. Operation of this equipment in a residential area is likely to cause harmful interference in which case the user will be required to correct the interference at his own expense.

### **FCC Conditions**

This device complies with part 15 of the FCC Rules. Operation is subject to the following two conditions:

1. This device may not cause harmful interference.
2. This device must accept any interference received, including interference that may cause undesired operation.

### **EU Conformity Statement**



This product and - if applicable - the supplied accessories too are marked with "CE" and comply therefore with the applicable harmonized

European standards listed under the EMC Directive 2014/30/EU, the RoHS Directive 2011/65/EU, the ATEX Directive 2014/34/EU.



2012/19/EU (WEEE directive): Products marked with this symbol cannot be disposed of as unsorted municipal waste in the European Union. For proper recycling, return this product to your local supplier

upon the purchase of equivalent new equipment, or dispose of it at designated collection points. For more information see:

[www.recyclethis.info](http://www.recyclethis.info)



2006/66/EC (battery directive): This product contains a battery that cannot be disposed of as



unsorted municipal waste in the European Union. See the product documentation for specific battery information. The battery is marked with this symbol, which may include lettering to indicate cadmium (Cd), lead (Pb), or mercury (Hg). For proper recycling, return the battery to your supplier or to a designated collection point. For more information see: [www.recyclethis.info](http://www.recyclethis.info)

### **Intended use of the camera**

**ATEX:**  II 2 G D Ex db IIC T6 Gb/Ex tb IIIC T80°C Db IP68

**IECEX:** Ex db IIC T6 Gb/Ex tb IIIC T80°C Db IP68

**UL (Zone):** Class I, Zone 1, AEx db IIC T6; Zone 21, AEx tb IIIC T80°C

**cUL (Zone):** Ex db IIC T6 Gb X; Ex tb IIIC T80°C Db X

**Hazardous Area Classification:** Zone 1, Zone 2, Zone 21, Zone 22.

**Hazardous Location Classification:** Class I, Zone 1, Class I, Zone 2;

Zone 21, Zone 22

**IP Degree:** IP68 (2m, 2h)

### **Ex Standards:**

IEC 60079-0: 2017      EN 60079-0: 2018

IEC 60079-1: 2014      EN 60079-1: 2014

IEC 60079-31: 2013      EN 60079-31: 2014

UL 60079-0: 2019      CSA 60079-0: 19

UL 60079-1: 2015      CSA 60079-1: 16





UL 60079-31: 2015

CSA 60079-31: 15

**Nameplate:**

Explosion-Proof Network Bullet Camera			
Product Model: Protection Level: IP68(2m/2h) Working Voltage: AC100~240V B/E/E 802.3at (42.5-57V DC) Product No.: xxxxxxxxxx Date of Production: xxxxxx	Temperature: -40°C ~ +60°C Working Current: <math>\leq 1000\text{mA}</math>	Explosion-Proof Sign: Class I, Zone 1, AEx db IIC T6 Zone 2L, AEx tb IIC T80°C Db Ex db IIC T6 Gb II Ex tb IIC T80°C Db II	WARNING: DO NOT OPEN WHEN AN EXPLOSIVE ATMOSPHERE IS PRESENT. POTENTIAL ELECTROSTATIC CHARGING HAZARD - SEE INSTRUCTIONS. THE FLAMEPROOF JOINTS ARE NOT INTENDED TO BE REPAIRED. FOR PROPER SELECTION OF CABLES AND CONDUIT FITTINGS - SEE INSTRUCTIONS. CAUTION: USE M6x1.8/1.4 FASTENERS WITH YIELD STRENGTH $\geq 450\text{MPa}$ . AVERTISSEMENT: S'OUVERT EN PRÉSENCE D'UNE ATMOSPHÈRE EXPLOSIVE, DANGER POTENTIEL DE CHARGE ÉLECTROSTATIQUE - VOIR LES INSTRUCTIONS. LES JOINTS ANTÉRIEURS NE SONT PAS RÉPARABLES. POUR LE BON CHOIX DES CÂBLES ET DES ACCESSOIRES DE TRAVAIL - VOIR LES INSTRUCTIONS. PRÉSENCE : UTILISER DES FIXATIONS AVEC UNE LIMITE D'ÉLASTICITÉ $\geq 450\text{MPa}$ . M25x1.5
Hangzhou Hikvision Digital Technology Co., Ltd. No.555 Qianmo Road, Binjiang District, Hangzhou, China		 OMBB FOR USE IN REGULATED LOCATIONS M25x1.5	

Explosion-Proof Network Bullet Camera			
Product Model: Protection Level: IP68(2m/2h) Working Voltage: AC100~240V B/E/E 802.3at (42.5-57V DC) Product No.: xxxxxxxxxx Date of Production: xxxxxxxx	Temperature: -40°C ~ +60°C Working Current: <math>\leq 1000\text{mA}</math>	DEMKO 20 ATEX 2250X  II 2 G Ex db IIC T6 Gb  II 2 D Ex tb IIC T80°C Db IECEx UL 20.0035X	WARNING: DO NOT OPEN WHEN AN EXPLOSIVE ATMOSPHERE IS PRESENT. POTENTIAL ELECTROSTATIC CHARGING HAZARD - SEE INSTRUCTIONS. CAUTION: USE M6x1.8/1.4 FASTENERS WITH YIELD STRENGTH $\geq 450\text{MPa}$ . THE FLAMEPROOF JOINTS ARE NOT INTENDED TO BE REPAIRED. M25x1.5
Hangzhou Hikvision Digital Technology Co., Ltd. No.555 Qianmo Road, Binjiang District, Hangzhou, China		Ex db IIC T6 Gb Ex tb IIC T80°C Db	 0035

Ambient Temperature:  $-30^{\circ}\text{C} \sim +60^{\circ}\text{C}$ , or  $-40^{\circ}\text{C} \sim +60^{\circ}\text{C}$  if the camera model has an “H” in its suffix.

Température ambiante :  $-30^{\circ}\text{C} \sim +60^{\circ}\text{C}$ , ou  $-40^{\circ}\text{C} \sim +60^{\circ}\text{C}$  si le modèle de l'appareil contient un « H » dans son suffixe.

**Industry Canada ICES-003 Compliance****Conformité Industrie Canada ICES-003**

This device meets the CAN ICES-3 (A)/NMB-3(A) standards requirements.

Ce dispositif répond aux exigences des normes CAN ICES-3 (A)/NMB-3(A).

**Warning:****Avertissement :**

This is a class A product. In a domestic environment this product may cause radio interference in which case the user may be required to take adequate measures.



Il s'agit d'un produit de classe A. Dans un environnement domestique, ce produit peut provoquer des interférences radio, auquel cas l'utilisateur peut être amené à prendre les mesures qui s'imposent.

## Safety Instruction

### Directives de sécurité

These instructions are intended to ensure that user can use the product correctly to avoid danger or property loss.

Les présentes directives visent à garantir que l'utilisateur puisse utiliser le produit adéquatement afin d'éviter tout danger ou perte matérielle.

The precaution measure is divided into "Warnings" and "Cautions"

La mesure de précaution est divisée en «avertissements» et en «mises en garde»

**Warnings:** Serious injury or death may occur if any of the warnings are neglected.



**Avertissements :** De graves blessures et même la mort peuvent survenir si l'un des avertissements n'est pas respecté.

**Cautions:** Injury or equipment damage may occur if any of the cautions are neglected.

**Mises en garde :** Une blessure ou un bris d'équipement peuvent survenir si l'une des mises en garde n'est pas respectée.





	
<p><b>Warnings</b> Follow these safeguards to prevent serious injury or death.</p> <p><b>Avertissements</b> Suivez ces mesures de sécurité afin d'éviter des blessures graves ou la mort.</p>	<p><b>Cautions</b> Follow these precautions to prevent potential injury or material damage.</p> <p><b>Mises en garde</b> Suivez ces mesures de prévention afin d'éviter toute blessure ou tout dommage matériel.</p>



### Warnings

### Avertissements

- For device with this sticker, this device is intended for installation in a restricted access location, access can only be gained by service persons or by users who have been instructed about the reasons for the restrictions applied to the location and about any precautions that shall be taken.



Si l'appareil est doté de cet autocollant, il est destiné à être installé dans un endroit à accès restreint atteignable uniquement par le personnel d'entretien ou des utilisateurs qui ont été informés des raisons des restrictions appliquées à l'emplacement et des précautions à prendre.



- Proper configuration of all passwords and other security settings is the responsibility of the installer and/or end-user.

La configuration appropriée de tous les mots de passe et autres paramètres de sécurité relève de la responsabilité de l'installateur ou de l'utilisateur final.

- Do not stare at the operating light source. May be harmful to the eyes. Wear appropriate eye protection or do not turn on the supplement light when you assemble, install or maintain the camera.

Ne pas regarder la source de lumière. Cela peut être nocif pour les yeux. Porter un dispositif de protection oculaire approprié ou ne pas allumer la lampe d'appoint lors du montage, de l'installation ou de l'entretien de l'appareil.

- The both internal and external earthing shall be connected reliably.

Les mises à la terre interne et externe doivent être adéquatement connectées.

Ground wire cross-sectional area of not less than the phase connector cross-sectional area level, at least 4 mm<sup>2</sup>.

La zone transversale du fil de mise à la terre ne doit pas être inférieure au niveau de la zone transversale du connecteur de phase, au moins 4 mm<sup>2</sup>.

- Suitable IECEx/ATEX certified flameproof 'db' and dust ignition protection 'tb' cable glands or listed fittings with same hazardous location classifications, correctly installed and suitable for the conditions of use.



Des presse-étoupes antidéflagrants certifiés IECEx/ATEX « db » avec protection anti-poussière « tb » ou raccords répertoriés avec les mêmes classifications pour zones dangereuses, adéquatement installées et adaptées aux conditions d'utilisation.

- IECEx/ATEX certified cable glands are needed during the installation.

Les presse-étoupes doivent être certifiés IECEx/ATEX lors de l'installation.

- All the electrical operation should be strictly compliance with the electrical safety regulations, fire prevention regulations and other related regulations of the nation and region.

Toute exploitation de matériel électrique doit être rigoureusement conforme aux règlements de sécurité électrique, de prévention des incendies et autres réglementations nationales et régionales.

- Make sure that the power has been disconnected before you wire, install or disassemble the camera. Never wire, install or disassemble the camera in explosive environment.

Assurez-vous que l'alimentation a été déconnectée avant de câbler, d'installer ou de démonter la caméra. Ne jamais câbler, installer ou démonter la caméra dans un environnement explosif.

- Do not connect several devices to one power adapter as adapter overload may cause over-heating or a fire hazard.



Ne pas connecter plusieurs appareils à un seul adaptateur d'alimentation, car une surcharge de l'adaptateur peut entraîner une surchauffe et un risque d'incendie.

- To avoid fire danger caused by electrostatic charge, never touch or wipe the camera in explosive environment. Perform the wiping and replacing accessories only under non-explosive environment with the provided glove.

Pour éviter tout risque d'incendie dû à une charge électrostatique, ne touchez et n'essayez jamais la caméra dans un environnement explosif. Procédez à l'essuyage et au remplacement des accessoires uniquement dans un environnement non explosif à l'aide du gant fourni.

- When the camera is installed on wall or ceiling, the device shall be firmly fixed.

Lorsque la caméra est installée au mur ou au plafond, elle doit être fermement fixée.

- If smoke, odors or noise rise from the camera, turn off the power at once and unplug the power cable, and then contact the service center.

Si de la fumée, des odeurs ou du bruit proviennent de la caméra, coupez l'alimentation aussitôt et débranchez le câble d'alimentation, puis communiquez avec le centre de service.

- If the camera does not work properly, contact your dealer or the nearest service center. Never attempt to disassemble the speed dome yourself. (We shall not assume any responsibility for problems caused by unauthorized repair or maintenance.)



Si la caméra ne fonctionne pas adéquatement, contactez votre distributeur ou le centre de service le plus près. N'essayez jamais de démonter la caméra dôme haute vitesse par vous-même. (Nous déclinons toute responsabilité pour des problèmes causés par une réparation ou un entretien non autorisés.)

- The flameproof joints are not intended to be repaired.  
Les joints antidéflagrants ne peuvent être réparés.
- When assembly, operation and maintenance, the operator must follow the requirements of the IEC 60079-14: latest version Explosive atmosphere- Part 14: Electrical installation design, selection and erection, beside of the manufacturer's operation instruction or its National equivalent. In the United States, when assembly, operation and maintenance, the operator must follow the requirements of Article 505 or 506 in the National Electrical Code, ANSI/NFPA 70.

Lors de l'assemblage, de l'utilisation et de l'entretien, l'utilisateur doit respecter les exigences de la norme IEC 60079-14 : dernière version Atmosphère explosive - Partie 14 : Conception, choix et montage de l'installation électrique, outre les recommandations d'utilisation du fabricant ou leur équivalent national. Aux États-Unis, lors du montage, de l'utilisation et de l'entretien, l'opérateur doit respecter les exigences de l'article 505 ou 506 du National Electrical Code, ANSI/NFPA 70.



- In Canada, CSA C22.1, when assembly, operation and maintenance, the operator must follow the requirements of Canadian Electrical Code, Part I.

Au Canada, lors du montage, de l'utilisation et de l'entretien, l'opérateur doit respecter les exigences de la partie I du Code canadien de l'électricité (CSA C22.1).

- Please select cable and conduit fittings suitable for above +70° C.

Sélectionner les raccords de câbles et de conduits adaptés à plus de +70 °C.



### **Cautions**

#### **Mises en garde**

- The internal grounding terminal shall be used for the equipment grounding connection and that the external terminal is for a supplementary bonding connection where local codes or authorities permit or require such connection.

La borne de mise à la terre interne doit être utilisée pour la connexion de MALT de l'équipement et la borne externe sert à une connexion de MALT supplémentaire lorsque les codes locaux ou autorités locales autorisent ou exigent une telle connexion.

- Make sure the power supply voltage is correct before using the camera.

Assurez-vous que la tension d'alimentation est adéquate avant d'utiliser la caméra.



- Do not drop the camera or subject it to physical shock.  
Ne laissez pas tomber la caméra et ne la soumettez pas à un choc physique.
- To ensure explosion-proof performance, do not damage explosion-proof surface.  
Pour assurer une performance antidéflagrante, ne pas endommager la surface antidéflagrante.
- Do not touch sensor modules with fingers. If cleaning is necessary, use clean cloth with a bit of ethanol and wipe it gently. If the camera will not be used for an extended period, please replace the lens cap to protect the sensor from dirt.  
Ne touchez pas les modules de capteur avec les doigts. Si un nettoyage est requis, utilisez un chiffon propre et un peu d'éthanol et essuyez-les délicatement. Si la caméra ne sert pas pendant une période prolongée, veuillez remettre le capuchon protecteur sur la lentille pour protéger le capteur de la poussière.
- Do not aim the camera at the sun or extra bright places. Blooming or smearing may occur otherwise (which is not a malfunction), and affect the endurance of sensor at the same time.  
N'orientez pas la caméra vers le soleil ou vers des endroits très lumineux. Autrement, un effet de voile ou de bariolage peut apparaître (ce qui n'est pas un dysfonctionnement), et cela pourrait affecter tout à la fois l'endurance du capteur.



- The sensor may be burned out by a laser beam, so when any laser equipment is in using, make sure that the surface of sensor will not be exposed to the laser beam.

Un faisceau laser peut brûler le capteur et donc, lorsqu'un équipement laser est utilisé, assurez-vous que la surface du capteur ne soit pas exposée au faisceau laser.

- Do not place the camera in extremely hot, cold (the operating temperature shall be  $-30^{\circ}\text{C} \sim +60^{\circ}\text{C}$ , or  $-40^{\circ}\text{C} \sim +60^{\circ}\text{C}$  if the camera model has an "H" in its suffix), dusty or damp locations, and do not expose it to high electromagnetic radiation.

Ne pas placer l'appareil dans un endroit extrêmement chaud ou froid (la température de fonctionnement doit se situer entre  $-30^{\circ}\text{C} \sim +60^{\circ}\text{C}$ , ou  $-40^{\circ}\text{C} \sim +60^{\circ}\text{C}$  si le modèle de l'appareil contient un « H » dans son suffixe) ni dans des endroits poussiéreux ou humides, et ne pas l'exposer à un rayonnement électromagnétique élevé.

- To avoid heat accumulation, good ventilation is required for operating environment.

Pour éviter l'accumulation de chaleur, une bonne ventilation est requise dans le milieu de fonctionnement.

- Keep the camera away from liquid while in use.

Gardez la caméra à l'écart du liquide pendant qu'elle fonctionne.

- While in delivery, the camera shall be packed in its original packing, or packing of the same texture.

Pendant la livraison, la caméra doit être emballée dans son emballage d'origine ou dans un emballage de même texture.





- Regular part replacement: a few parts (e.g. electrolytic capacitor) of the equipment shall be replaced regularly according to their average enduring time. The average time varies because of differences between operating environment and using history, so regular checking is recommended for all the users. Please contact with your dealer for more details.

Remplacement régulier des pièces : quelques pièces (par exemple le condensateur électrolytique) de l'équipement doivent être remplacées régulièrement en fonction de leur durée de vie moyenne. Le temps moyen varie en raison des différences entre les milieux d'utilisation et de l'historique d'utilisation, donc une vérification régulière est recommandée à tous les utilisateurs. Veuillez communiquer avec votre distributeur pour plus de détails.

- DO NOT replace the battery by yourself. If the battery is damaged, contact the dealer.  
NE PAS remplacer la pile vous-même. Si la pile est endommagée, contacter le revendeur.
- Improper use or replacement of the battery may result in hazard of explosion. Replace with the same or equivalent type only. Dispose of used batteries according to the instructions provided by the battery manufacturer.

L'utilisation ou le remplacement inadéquats de la pile peuvent entraîner un risque d'explosion. Remplacez-la par le même type ou l'équivalent du même type seulement. Jetez les piles usagées conformément aux directives fournies par le fabricant de la pile.



- If the product does not work properly, please contact your dealer or the nearest service center. Never attempt to disassemble the camera yourself. (We shall not assume any responsibility for problems caused by unauthorized repair or maintenance.)

Si l'appareil ne fonctionne pas correctement, veuillez contacter votre distributeur ou le centre de service le plus proche.

N'essayez jamais de démonter vous-même la caméra. (Nous déclinons toute responsabilité pour des problèmes causés par une réparation ou un entretien non autorisés.)



## Table of Contents

<b>1 Introduction</b> .....	<b>19</b>
1.1 Overview.....	19
1.2 Model Description.....	19
<b>2 Appearance</b> .....	<b>21</b>
2.1 Overview.....	21
2.2 Cable Description.....	22
<b>3 Installation</b> .....	<b>24</b>
3.1 Wall Mounting.....	25
3.2 Cable Connection.....	28
<b>4 Setting the Network Camera over the LAN</b> .....	<b>32</b>
4.1 Wiring.....	32
4.2 Activating the Camera.....	33
4.2.1 Activation via Web Browser.....	33
4.2.2 Activation via SADP Software.....	34
4.3 Modifying the IP Address.....	36
<b>5 Accessing via Web Browser</b> .....	<b>39</b>
<b>6 Operating via Hik-Connect App</b> .....	<b>41</b>
6.1 Enable Hik-Connect Service on Camera.....	41
6.1.1 Enable Hik-Connect Service via SADP Software ..	41
6.1.2 Enable Hik-Connect Service via Web Browser ....	42
6.2 Hik-Connect Setup.....	44
6.3 Adding Camera to Hik-Connect.....	44
6.4 Initializing the Memory Card.....	46



# 1 Introduction

## 1.1 Overview

Explosion-proof network camera is a surveillance product capable of video/audio collecting, smart encoding and network transmitting. It adopts an embedded system and a high-performed hardware process platform to achieve good stability and reliability.

You can visit and configure your camera via web browser and client software.

Explosion-proof network camera adopts a stainless steel enclosure, receiving an IP68 rating for ingress protection.

**Application Scenarios:** oil industry, mine fields, chemical industry, port, grain processing industry, etc.

## 1.2 Model Description

This manual is applicable to the following models:

Table 1-1 Applicable Model List

Model List		
DS-2XE6825G0-IZHS	DS-2XE6845G0-LZHS	DS-2XE6885G0-IZ
DS-2XE6845G0-IZHS	DS-2XE6885G0-LZHS	DS-2XE6825G0-LZ
DS-2XE6885G0-IZHS	DS-2XE6825G0-IZ	DS-2XE6845G0-LZ
DS-2XE6825G0-LZHS	DS-2XE6845G0-IZ	DS-2XE6885G0-LZ

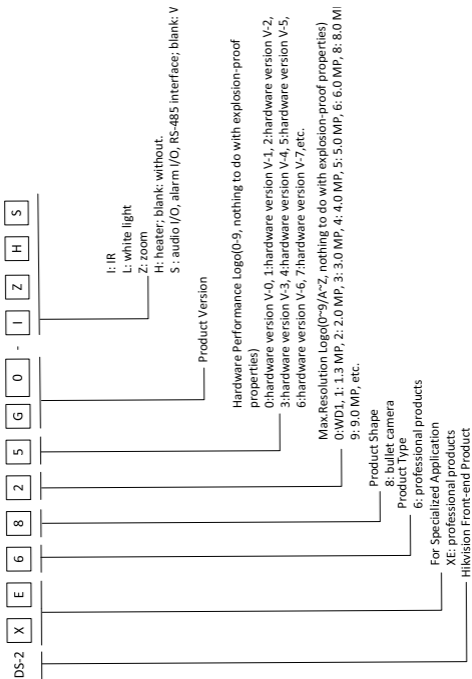

Figure 1-1 Model Explanation



## 2 Appearance

---

### 2.1 Overview

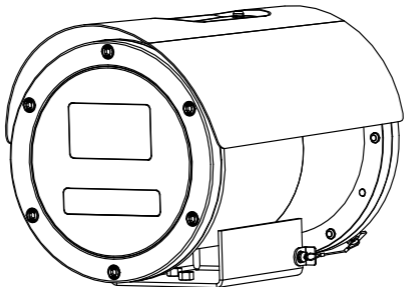

Figure 2-1 Overview



## 2.2 Cable Description

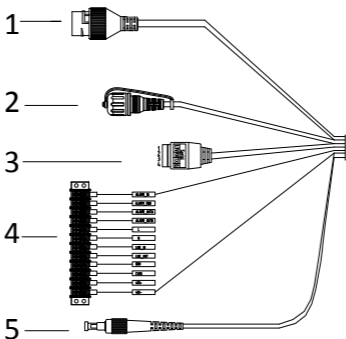

Figure 2-2 Overview of Cables

Table 2-1 Description of Cables

No.	Description	No.	Description
1	Network Interface	4	Alarm*/Power/Audio*/Grounding/CV BS/RS-485 Interface
2	Reset Interface	5	Fiber Optical Interface



3	Serial Port		
---	-------------	--	--





## 3 Installation

---

### *Before you start:*

- Suitable certified flameproof 'd' and dust ignition protection 't' cable glands, correctly installed and suitable for the conditions of use.
- IECEx/ATEX certified cable glands are needed during the installation.
- Make sure the device in the package is in good condition and all the assembly parts are included.
- The standard power supply is 100 to 240 VAC, please make sure your power supply matches with your camera.
- Make sure all the related equipment is power-off during the installation.
- Check the specification of the products for the installation environment.
- Make sure that the wall is strong enough to withstand four times the weight of the camera and the bracket.

For the camera that supports IR, you are required to pay attention to the following precautions to prevent IR reflection:

- Dust or grease on the dome cover will cause IR reflection. Please do not remove the dome cover film until the installation is finished. If there is dust or grease on the dome cover, clean the dome cover with clean soft cloth and isopropyl alcohol.



- Make sure that there is no reflective surface too close to the camera lens. The IR light from the camera may reflect back into the lens causing reflection.
- The foam ring around the lens must be seated flush against the inner surface of the bubble to isolate the lens from the IR LEDs. Fasten the dome cover to camera body so that the foam ring and the dome cover are attached seamlessly.

### 3.1 Wall Mounting

**Before you start:**

Loosen the screws on the side of the PT joint to uninstall it.

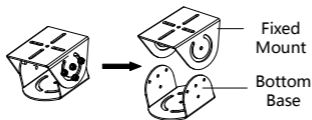

Figure 3-1 PT Joint

**Steps:**

1. Install the fixed mount of the PT joint to the camera with screws.

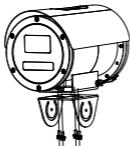

Figure 3-2 Install Fixed Mount to the Camera



2. Install the bottom base of the PT joint to the wall mounting bracket with the screws.

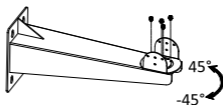

Figure 3-3 Install Bottom Base to the Bracket

3. Drill holes on the mounting plate and install the bracket to the mounting plate with the screws.

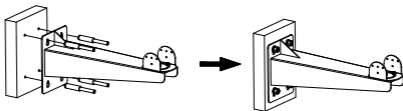

Figure 3-4 Install the Bracket

4. Hook the safety rope to the camera and the bracket.

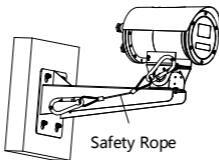

Figure 3-5 Hook the Safety Rope

5. Install the camera to the bracket with the screws.

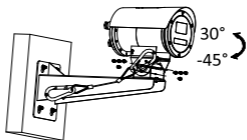

Figure 3-6 Install the Camera



## 3.2 Cable Connection

### Steps:

1. Loosen the screws to remove the back cover.

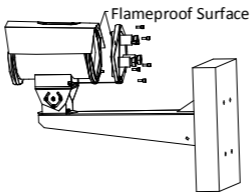

Figure 3-7 Remove the Back Cover

### Note:

- Do not unhook the safety rope from the camera when removing the back cover. Be careful with the flameproof surface in case it is damaged.
  - Refer to Figure 3-7 for the entry places. The maximum permitted number of these entries is 3.
2. Loosen the gland nut to take out the gasket and sealing ring.

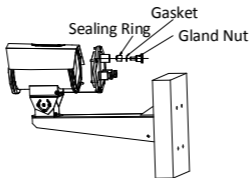



Figure 3-8 Loosen the Gland Nut

- Loosen the thread cap of the adapter. Thread the cable through the adapter, sealing ring, conduit sealing fitting and the conduit.

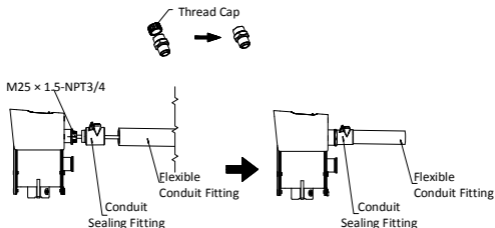

Figure 3-9 Thread the Cable through the Conduit

- Secure the adapter to the back cover with the wrench.

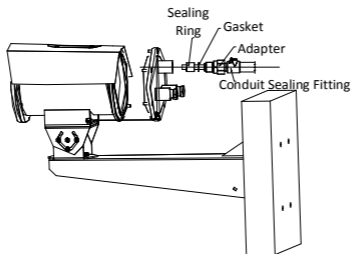



Figure 3-10 Secure Adapter to the Back Cover

5. Connect the cables to the corresponding terminal blocks and fasten the gland nut.
6. Install the back cover to the camera with the screws.

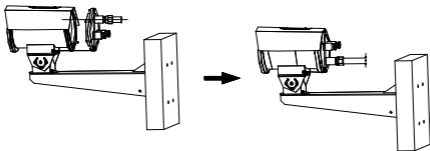

Figure 3-11 Install the Back Cover

**Note:**

- The flexible conduit shall then connect to a junction box use in hazardous locations. The cable needs to be entirely protected within hazardous locations for Class I, Zone 1.
  - The conduit sealing fitting and flexible connection fitting should be UL and c-UL Listed for the same Class, Group and Division or equivalent Zone as marked on this manufacturer's nameplate.
  - An explosionproof conduit seal shall be applied by the installer or user of the equipment according to the National Electrical Code® or the equivalent in Canada.
7. Route the camera cables according to the figure below.

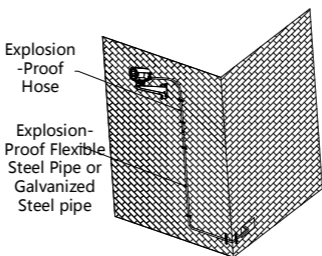

Figure 3-12 Route Cables

**Note:**

The cables connected to the control room should be protected by explosion-proof flexible steel pipe or galvanized steel pipe.





## 4 Setting the Network Camera over the LAN

### Note:

You shall acknowledge that the use of the product with Internet access might be under network security risks. For avoidance of any network attacks and information leakage, please strengthen your own protection.

If the product does not work properly, contact your dealer or the nearest service center for help.

### 4.1 Wiring

Connect the camera to network according to the following figures.

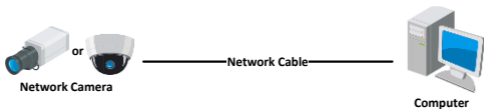

Figure 4-1 Connecting Directly

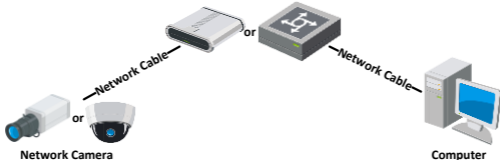

Figure 4-2 Connecting via a Switch or a Router



## 4.2 Activating the Camera

You are required to activate the camera first by setting a strong password for it before you can use the camera.

Activation via Web Browser, Activation via SADP, and Activation via Client Software are all supported. We will take activation via SADP software and Activation via Web Browser as examples to introduce the camera activation.

### **Note:**

Refer to the User Manual of Network Camera for Activation via Client Software.

### 4.2.1 Activation via Web Browser

#### **Steps:**

1. Power on the camera. Connect the camera to your computer or the switch/router which your computer connects to.
2. Input the IP address into the address bar of the web browser, and press Enter to enter the activation interface.

#### **Notes:**

- The default IP address of the camera is 192.168.1.64.
- The computer and the camera should belong to the same subnet.
- For the camera enables the DHCP by default, you need to use the SADP software to search the IP address.

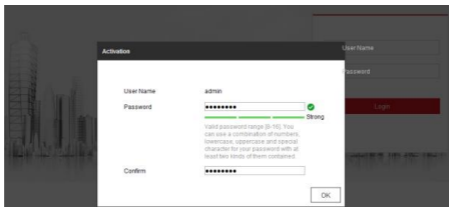

Figure 4-3 Activation Interface (Web)

3. Create a password and input the password into the password field.



**STRONG PASSWORD RECOMMENDED**— *We highly recommend you create a strong password of your own choosing (using a minimum of 8 characters, including upper case letters, lower case letters, numbers, and special characters) in order to increase the security of your product. And we recommend you reset your password regularly, especially in the high security system, resetting the password monthly or weekly can better protect your product.*

4. Confirm the password.
5. Click **OK** to save the password and enter the live view interface.

### 4.2.2 Activation via SADP Software

SADP software is used for detecting the online device, activating the camera, and resetting the password.

Get the SADP software from the supplied disk or the official website, and install the SADP according to the prompts.



Follow the steps to activate the camera.

### Steps:

1. Run the SADP software to search the online devices.
2. Check the device status from the device list, and select the inactive device.

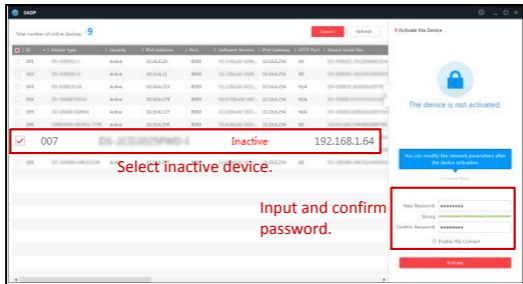

Figure 4-4 SADP Interface

### Note:

The SADP software supports activating the camera in batch. Refer to the user manual of SADP software for details.

3. Create and input the new password in the password field, and confirm the password.



**STRONG PASSWORD RECOMMENDED**– *We highly recommend you create a strong password of your own choosing (using a minimum of 8 characters, including upper case letters, lower case letters, numbers, and special characters) in order to increase the security of your product. And we recommend you reset your password regularly, especially in the high security system, resetting the password monthly or weekly can better protect your product.*

**Note:**

You can enable the Hik-Connect service for the device during activation. Refer to Chapter 6.1 for detailed information.

4. Click **Activate** to start activation.

You can check whether the activation is completed on the popup window. If activation failed, make sure that the password meets the requirement and try again.

## 4.3 Modifying the IP Address

**Purpose:**

To view and configure the camera via LAN (Local Area Network), you need to connect the network camera in the same subnet with your PC.

Use the SADP software or client software to search and change the IP address of the device. We take modifying the IP Address via SADP software as an example to introduce the IP address modification.

For IP address modification via client software, refer to the user manual of client software.



**Steps:**

1. Run the SADP software.
2. Select an active device.
3. Change the device IP address to the same subnet with your computer by either modifying the IP address manually or checking the checkbox of **Enable DHCP**.

**Modify Network Parameters**

Enable DHCP  
 Enable Hik-Connect

Device Serial No.:

IP Address:

Port:

Subnet Mask:

Gateway:

IPv6 Address:

IPv6 Gateway:

IPv6 Prefix Length:

HTTP Port:

Security Verification

Admin Password:

[Modify](#)

[Forgot Password](#)

Figure 4-5 Modify the IP Address



**Note:**

You can enable the Hik-Connect service for the device during activation. Refer to Chapter 6.1 for detailed information.

4. Input the admin password and click **Modify** to activate your IP address modification.

The batch IP address modification is supported by the SADP. Refer to the user manual of SADP for details.



## 5 Accessing via Web Browser

---

### **System Requirement:**

Operating System: Microsoft Windows XP SP1 and above version

CPU: 2.0 GHz or higher

RAM: 1G or higher

Display: 1024×768 resolution or higher

Web Browser: Internet Explorer 8.0 and above version, Apple Safari 5.0.2 and above version, Mozilla Firefox 5.0 and above version and Google Chrome 18 and above version

### **Steps:**

1. Open the web browser.
2. In the browser address bar, input the IP address of the network camera, and press the **Enter** key to enter the login interface.

#### **Note:**

- The default IP address is 192.168.1.64. You are recommended to change the IP address to the same subnet with your computer.

3. Input the user name and password.

The admin user should configure the device accounts and user/operator permissions properly. Delete the unnecessary accounts and user/operator permissions.

#### **Note:**

The device IP address gets locked if the admin user performs 7 failed password attempts (5 attempts for the user/operator).





4. Click **Login**.



Figure 5-1 Login Interface

5. Install the plug-in before viewing the live video and managing the camera. Follow the installation prompts to install the plug-in.

**Note:**

You may have to close the web browser to finish the installation of the plug-in.

[Please click here to download and install the plug-in. Close the browser when installing the plug-in.](#)

Figure 5-2 Download Plug-in

6. Reopen the web browser after the installation of the plug-in and repeat steps 2 to 4 to login.

**Note:**

For detailed instructions of further configuration, please refer to the user manual of network camera.



## 6 Operating via Hik-Connect App

---

### *Purpose:*

Hik-Connect is an application for mobile devices. With the App, you can view live image of the camera, receive alarm notification and so on.

### *Note:*

Hik-Connect service is not supported by certain camera models.

### 6.1 Enable Hik-Connect Service on Camera

#### *Purpose:*

Hik-Connect service should be enabled on your camera before using the service.

You can enable the service through SADP software or web browser.

#### 6.1.1 Enable Hik-Connect Service via SADP Software

##### *Steps:*

1. Check the checkbox of **Enable Hik-Connect** on:
  - 1). "Activate the Device" page during camera activation, refer to Chapter 4.2.2.
  - 2). Or "Modify Network Parameters" page during modifying IP address, refer to Chapter 4.3.
2. Create a verification code or change the verification code.

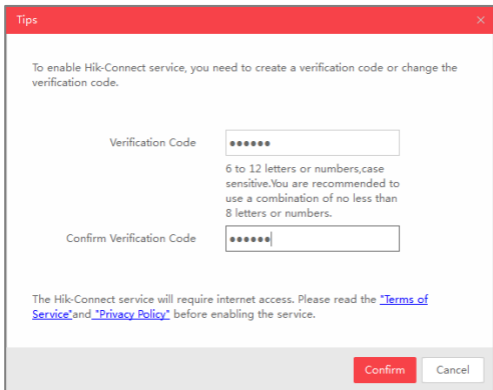

Figure 6-1 Verification Code Setting (SADP)

**Note:**

The verification code is required when you add the camera to Hik-Connect app.

3. Click and read "Terms of Service" and "Privacy Policy".
4. Confirm the settings.

### 6.1.2 Enable Hik-Connect Service via Web Browser

**Before you start:**

You need to activate the camera before enabling the service. Refer to Chapter 4.2.



**Steps:**

1. Access the camera via web browser. Refer to Chapter 5.
2. Enter platform access configuration interface: **Configuration > Network > Advanced Settings > Platform Access.**

Enable

Platform Access Mode

Server IP   Custom

Register Status

Verification Code

6 to 12 letters (a to z, A to Z) or numbers (0 to 9), case sensitive. You are recommended to use

Figure 6-2 Platform Access Configuration (Web)

3. Select **Platform Access Mode** as **Hik-Connect**.
4. Check the checkbox of **Enable**.
5. Click and read "Terms of Service" and "Privacy Policy" in pop-up window.
6. Create a verification code or change the verification code for the camera.

**Note:**

The verification code is required when you add the camera to Hik-Connect app.

7. Save the settings.



## 6.2 Hik-Connect Setup

### Steps:

1. Download and install the Hik-Connect app by searching “Hik-Connect” in App Store or Google Play™.
2. Launch the app and register for a Hik-Connect user account.
3. Log in Hik-Connect app after registration.

## 6.3 Adding Camera to Hik-Connect

### Before you start:

You need to enable the Hik-Connect service on camera before adding it to your Hik-Connect account. Refer to Chapter 6.1.

### Steps:

1. Use a network cable to connect the camera with a router if the camera does not support Wi-Fi.



Figure 6-3 Connect a Router

### Note:

After the camera connects to the network, please wait one minute before any operation on the camera using Hik-Connect app.

2. In the Hik-Connect app, tap “+” on the upper-right corner and then scan the QR code of the camera to add the camera.



You can find the QR code on the camera or on the cover of the Quick Start Guide of the camera in the package.

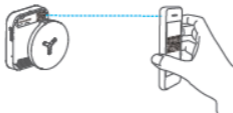



Figure 6-4 Scan QR Code

**Note:**

If the QR code is missing or too blur to be recognized, you can also add the camera by tapping the  icon and inputting the camera's serial number.

3. Input the verification code of your camera.

**Note:**

- The required verification code is the code you create or change when you enabling Hik-Connect service on camera.
- If you forget the verification code, you can check the current verification code on **Platform Access** configuration page via web browser.

4. Follow the prompts to set the network connection and add the camera to your Hik-Connect account.

**Note:**

For detailed information, refer to the user manual of the Hik-Connect app.



## 6.4 Initializing the Memory Card

Check the memory card status by tapping on the Storage Status in the Device Settings interface.

If the memory card status displays as Uninitialized, tap to initialize it. The status will then change to Normal. You can then start recording any event triggered video in the camera such as motion detection.

