



TurboHD
DS-2CE12H0T-PIRL
Bullet Camera
User Manual

Thank you for purchasing our product. If there are any questions, or requests, do not hesitate to contact the dealer.

This manual may contain several technical incorrect places or printing errors, and the content is subject to change without notice. Updates will be added to new versions of this manual. We will readily improve or update the products or procedures described in the manual.

1 Regulatory Information

1.1 FCC Information

Please take attention that changes or modification not expressly approved by the party responsible for compliance could void the user's authority to operate the equipment.

FCC Compliance: This equipment has been tested and found to comply with the limits for a Class A digital device, pursuant to part 15 of the FCC Rules. These limits are designed to provide reasonable protection against harmful interference when the equipment is operated in a commercial environment. This equipment generates, uses, and can radiate radio frequency energy and, if not installed and used in accordance with the instruction manual, may cause harmful interference to radio communications. Operation of this equipment in a residential area is likely to cause harmful interference in which case the user will be required to correct the interference at his own expense.

1.2 FCC Conditions

This device complies with part 15 of the FCC Rules. Operation is subject to the following two conditions:

1. This device may not cause harmful interference.
2. This device must accept any interference received, including interference that may cause undesired operation.

1.3 EU Conformity Statement

 This product and, if applicable, the supplied accessories too are marked with "CE" and comply therefore with the applicable harmonized European standards listed under the Low Voltage Directive 2014/35/EU, the EMC Directive 2014/30/EU, the RoHS Directive 2011/65/EU.

 **2012/19/EU (WEEE Directive):** Products marked with this symbol cannot be disposed of as unsorted municipal waste in the European Union. For proper recycling, return this product to your local supplier upon the purchase of equivalent new equipment, or dispose of it at designated collection points. For more information see: www.recyclethis.info.

 **2006/66/EC (Battery Directive):** This product contains a battery that cannot be disposed of as unsorted municipal waste in the European Union. See the product documentation for specific battery information. The battery is marked with this symbol, which may include lettering to indicate cadmium (Cd), lead (Pb), or mercury (Hg). For proper recycling, return the battery to your supplier or to a designated collection point. For more information see: www.recyclethis.info.

1.4 Industry Canada ICES-003 Compliance

This device meets the CAN ICES-3 (A)/NMB-3(A) standards requirements.

1.5 Warning

This is a class A product. In a domestic environment this product may cause radio interference in which case the user may be required to take adequate measures.



1.6 Safety Instruction

These instructions are intended to ensure that user can use the product correctly to avoid danger or property loss.

The precaution measure is divided into "Warnings" and "Cautions."

Warnings: Serious injury or death may occur if any of the warnings are neglected.

Cautions: Injury or equipment damage may occur if any of the cautions are neglected.

	
Warnings Follow these safeguards to prevent serious injury or death.	Cautions Follow these precautions to prevent potential injury or material damage.

1.7 Warnings

- In the use of the device, you must be in strict compliance with the electrical safety regulations of the nation and region.
- Input voltage should meet both the SELV (Safety Extra Low Voltage) and the Limited Power Source with 12 VDC according to the IEC60950-1 standard. Refer to technical specifications for detailed information.
- Do not connect multiple devices to one power adapter to avoid overheating or a fire hazard caused by overload.
- Make sure that the plug is firmly connected to the power socket.
- Make sure that the device is firmly fixed if wall mounting or ceiling mounting is adopted.
- If smoke, odor, or noise rise from the device, turn off the power at once and unplug the power cord, and then contact the service center.
- Never attempt to disassemble the camera by unprofessional personal.

1.8 Cautions

- Do not drop the camera or subject it to physical shock.
- Do not touch sensor modules with fingers.
- Do not place the camera in extremely hot, cold (the operating temperature shall be -40° to 60° C), dusty, or damp locations, and do not expose it to high electromagnetic radiation.
- If cleaning is necessary, use a clean cloth with a bit of ethanol and wipe it gently.
- Do not aim the camera at the sun or extra bright places.
- The sensor may be burned out by a laser beam, so when any laser equipment is in use, make sure that the surface of the sensor will not be exposed to the laser beam.
- Do not expose the device to high electromagnetic radiation or extremely hot, cold, dusty, or damp environment.
- To avoid heat accumulation, good ventilation is required for the operating environment.
- Keep the camera away from liquid while in use for non-waterproof device.
- While in delivery, the camera shall be packed in its original packing or packing of the same texture.

1.9 Mark Description

Table 0-1 Mark Description

Mark	Description
==	DC Voltage

2 Introduction

2.1 Product Features

The main features are as follows:

- High performance CMOS sensor
- IR cut filter with auto switch
- OSD menu with configurable parameters
- Auto white balance
- Internal synchronization
- SMART IR mode
- Visible alarm
- PIR detection
- 3-axis adjustment

2.2 Overview

2.2.1 Camera Overview

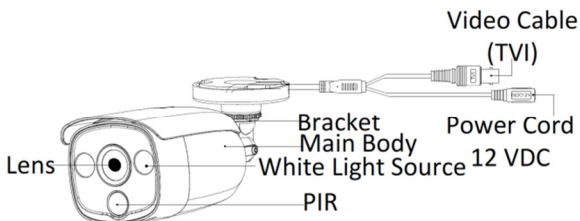

Figure 1, Camera Overview

Figure 1-2

3 Installation

Before you start

- Make sure that the device in the package is in good condition and all the assembly parts are included.
- Make sure that all the related equipment is powered off during the installation.
- Check the specification of the products for the installation environment.
- Check whether the power supply matches your power output to avoid damage.
- Make sure the wall is strong enough to withstand three times the weight of the camera and the mount.
- If the wall is cement, insert expansion bolts before installing the camera. If the wall is wood, use self-tapping screws to secure the camera.
- If the product does not function properly, contact your dealer or the nearest service center. Do NOT disassemble the camera for repair or maintenance yourself.

3.1 Camera Installation

3.1.1 Ceiling/Wall Mounting without Junction Box

Steps:

1. Paste the drill template (supplied) to where you want to install the camera.
2. Drill the screw holes according to the drill template and the cable

hole (optional) on the ceiling.

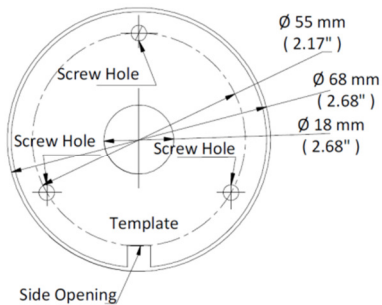

Figure 2, Drill Template

Note:

Drill the cable hole in the center of the drill template when using ceiling outlet to route the cable.

3. Route the cables through the cable hole (optional) or the side opening.
4. Fix the camera to the ceiling with supplied screws.

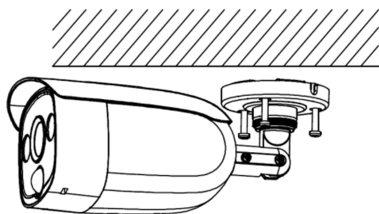

Figure 3, Fix the Camera to the Ceiling

Note:

- The supplied screw package contains self-tapping screws and expansion bolts.
- For cement wall/ceiling, expansion bolts are required to fix the camera. For wood wall/ceiling, self-tapping screws are required.

5. Connect the corresponding power cord and video cable.
6. Power on the camera to check whether the image on the monitor is at an optimum angle. If not, adjust the surveillance angle.

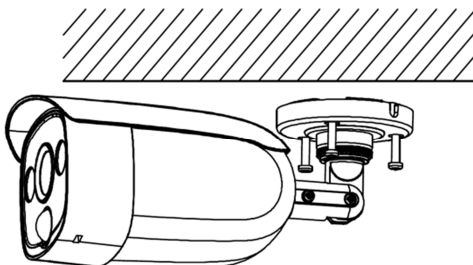

Figure 4, 3-Axis Adjustment

- 1). Loosen the no. 1 adjusting screw to adjust the pan position [0° to 360°]. Tighten the no. 1 adjusting screw.
- 2). Loosen the no.2 adjusting screw to adjust the tilting position [0° to 180°]. Tighten the no. 2 adjusting screw.
- 3). Loosen the no.3 adjusting screw to adjust the rotation position [0° to 360°]. Tighten the no.3 adjusting screw.

3.2 Ceiling/Wall Mounting with Junction Box

Before you start:

You must purchase a junction box separately.

Steps:

1. Paste the drill template on the ceiling/wall.
2. Drill screw holes and the cable hole (optional) in the ceiling/wall according to the holes of the drill template.

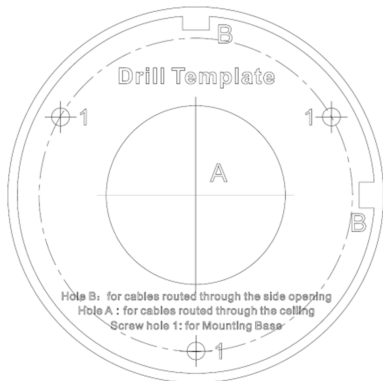

Figure 5, Drill Template

Note:

Drill the cable hole when using ceiling outlet to route the cable.

3. Take apart the junction box and align the screw holes of the bullet camera with those on the junction box's cover.
4. Fix the camera on the junction box's cover with three supplied screws.

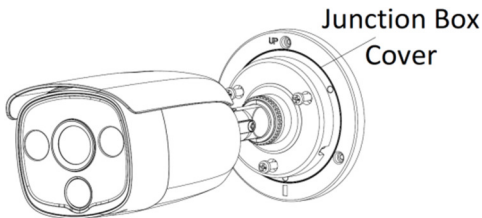

Figure 6, Install the Junction Box

5. Secure the junction box's body with supplied screws on the ceiling/wall.
6. Route the cables through the bottom cable hole or the side cable hole of the junction box.
7. Fasten the junction box cover to its body with supplied screws on the junction box's cover.

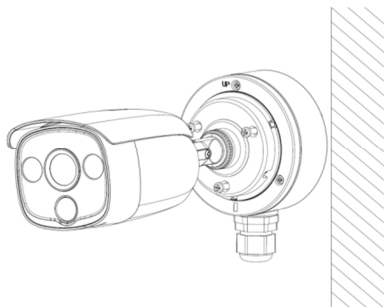



Figure 7, Combine the Junction Box's Cover with its Body

- Repeat step 5 and 6 of 2.2.1 *Ceiling/Wall Mounting without Junction Box* to complete the installation.

4 Menu Description

Purpose:

Call the menu by clicking the  button on the PTZ Control interface, or call the preset no.95.

Steps:

- Connect the camera to the TVI DVR and the monitor, as shown below.

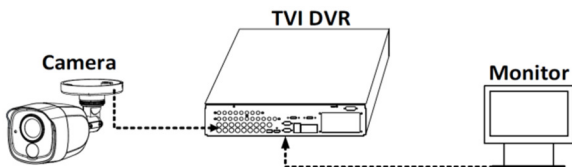



Figure 8, Connection

- Power on the analog camera, TVI DVR, and the monitor to view the image on the monitor.
- Click **PTZ Control** to enter the PTZ Control interface.
- Call the camera menu by clicking the  button or call the preset no. 95.

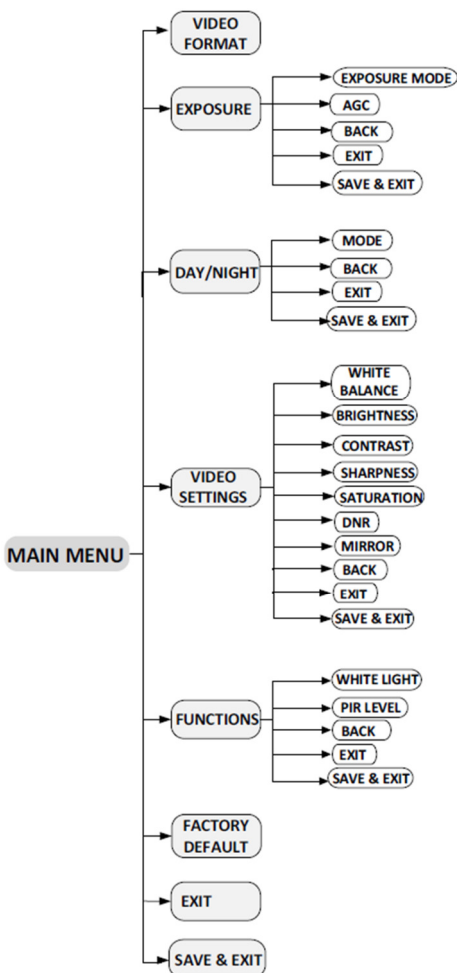

Figure 9, Main Menu Overview

5. Click the direction arrow to control the camera.

1).Click **Up/Down** direction button to select the item.

2).Click **Iris+** to confirm the selection.

3).Click **Left/Right** direction button to adjust the value of the selected item.

4.1 VIDEO FORMAT

You can set the video format to 5 MP @ 20 fps, 4 MP @ 25 fps, 4 MP @ 30 fps, 2 MP @ 25 fps, or 2 MP @ 30 fps.

4.2 EXPOSURE

4.2.1 EXPOSURE MODE

You can set the **EXPOSURE MODE** to **GLOBAL**, **BLC**, or **DWDR**.

- **GLOBAL**
GLOBAL refers to the normal exposure mode, which adjusts lighting distribution, variations, and non-standard processing.
- **BLC (Backlight Compensation)**
BLC (Backlight Compensation) compensates light to the object in the front to make it clear, but this may cause overexposure of the background where the light is strong.
- **DWDR (Digital Wide Dynamic Range)**
The digital wide dynamic range helps the camera provide clear images even under backlight circumstances. WDR balances the brightness level of the whole image and provides clear images with details.

4.2.2 AGC (Auto Gain Control)

It optimizes the clarity of the image in poor light conditions. The **AGC** level can be set as **HIGH**, **MEDIUM**, or **LOW**. Select **OFF** to disable the **AGC** function.

Note:

The noise will be amplified when the **AGC** is on.

4.2.3 DAY/NIGHT

COLOR, **B&W** (Black White), and **AUTO** are selectable for **DAY** and **NIGHT** switches.

Note:

Under the **LIGHTING** mode, the image is in color all the time, and there's no **DAY/NIGHT** setting in the menu.

- **COLOR**
The image is in color in day mode all the time.
- **B/W**
The image is black and white all the time. Turning the **IR LIGHT** on in poor light conditions will improve the image.
- **AUTO**
You can turn on/off the **IR LIGHT** and set the **SMART IR** value in this menu.
 - **IR LIGHT**
You can turn on/off the **IR LIGHT** to meet the circumstances.
 - **SMART IR**
The **Smart IR** function adjusts the light to its most suitable intensity and prevents the image from overexposure. The **SMART IR** value can be adjusted from 0 to 3. The greater the value, the more obvious the effect.

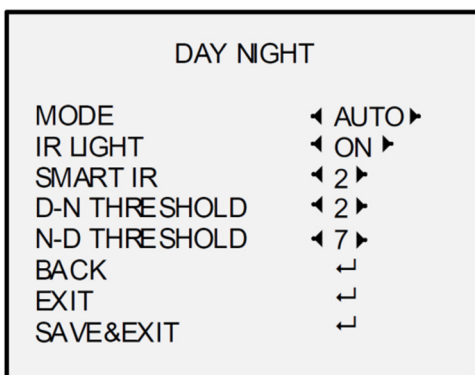

Figure 10, DAY NIGHT

- D-N THRESHOLD (Day to Night Threshold)**
 Day to Night Threshold controls the sensitivity of switching the day mode to night mode. You can set the value from 1 to 9. The larger the value, the more sensitive the camera.
- N-D THRESHOLD (Night to Day Threshold)**
 Night to Day Threshold controls the sensitivity of switching the night mode to day mode. You can set the value from 1 to 9. The larger the value, the more sensitive the camera.

4.3 VIDEO SETTINGS

Move the cursor to **VIDEO SETTINGS** and click **Iris+** to enter the submenu. **CONTRAST**, **SHARPNESS**, **COLOR GAIN**, **3 DNR**, and **MIRROR** are adjustable.

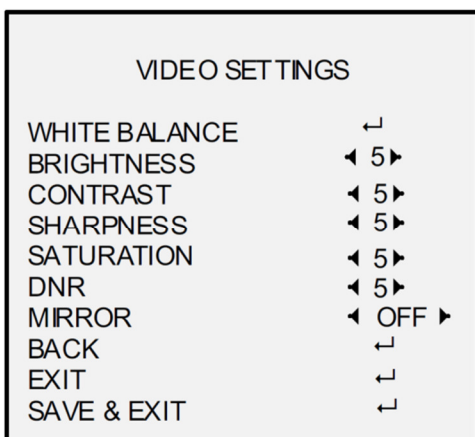

Figure 11, VIDEO SETTING

- WHITE BALANCE**
 White balance, the white rendition function of the camera, adjusts the color temperature according to the environment. It can remove unrealistic color casts in the image. You can set **WHITE BALANCE** mode to **AUTO** or **MANUAL**.
 - AUTO**
 Under **AUTO** mode, white balance is adjusted automatically according to the color temperature of the scene illumination.
 - MANUAL**
 You can set the **R-GAIN/B-GAIN** value from 1 to 255 to adjust the shades of red/blue color of the image.

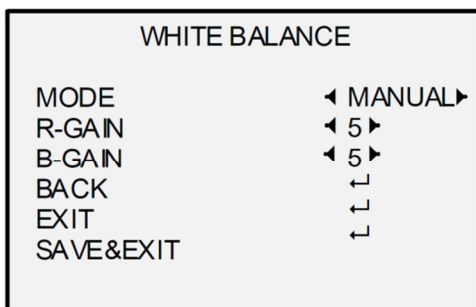

Figure 12, MWB MODE

- **BRIGHTNESS**
Brightness refers to the brightness of the image. You can set the brightness value from 1 to 9 to darken or brighten the image. The greater the value, the brighter the image.
- **CONTRAST**
This feature enhances the difference in color and light between parts of an image. You can set the **CONTRAST** value from 1 to 9.
- **SHARPNESS**
Sharpness determines the amount of detail the imaging system can reproduce. You can set the **SHARPNESS** value from 1 to 9.
- **SATURATION**
Adjust this feature to change the saturation of the color. The value ranges from 1 to 9.
- **DNR (Digital Noise Reduction)**
The **DNR** function can decrease the noise effect, especially when capturing moving images in poor light conditions, and delivers more accurate and sharper images. You can set the **DNR** value from 1 to 9.
- **MIRROR**
OFF, H, V, and **HV** are selectable for mirror.
OFF: The mirror function is disabled.
H: The image flips 180° horizontally.
V: The image flips 180° vertically.
HV: The image flips 180° both horizontally and vertically.

4.4 FUNCTIONS

- **WHITE LIGHT**
The embedded white light source can work as an visible alarm or lighting. In the **WHITE LIGHT** mode, you can set the mode to **ALARM, LIGHTING,** or **OFF.**
When you set the **WHITE LIGHT** to **ALARM,** you can set the Parameters in the **TRIGGER MODE** and the **ALARM MODE** to meet your needs.
 - **TRIGGER MODE**
 - > **DVR**
Set the **TRIGGER MODE** to **DVR.** In this way, the alarm signal is sent from the DVR and the camera works as the alarm detector in the process. Besides, the alarm type only supported by the DVR can also trigger the visible alarm in the camera.
 - > **CAMERA**
Set the **TRIGGER MODE** to **CAMERA,** the embedded PIR module sends the alarm signal to the visible alarm in the camera when the PIR module detects the alarm source.
 - **ALARM**
In the **ALARM** mode, you can set the **ALARM MODE** to **SOLID** or **FLASHING.**

FUNCTIONS	
WHITE LIGHT	◀ ALARM ▶
TRIGGER MODE	◀ CAMERA ▶
ALARM MODE	◀ SOLID ▶
TIME SETTING	◀ 15 S ▶
PIR LEVEL	◀ 3 ▶
BACK	↵
EXIT	↵
SAVE & EXIT	↵

Figure 13, ALARM MODE

> **SOLID**

Set the **ALARM MODE** to **SOLID**. In this way, the white light source turns on when the PIR module receives the alarm signal.

In the **TIME SETTING** you can set the time to 5s, 10s, 15s, 30s, or 60s, which means that the solid mode stays for the set time when the camera receives one alarm signal.

Note:

The solid mode will stay for another set time when a second alarm signal is received, and the rest can be done in the same way.

> **FLASHING**

Set the **ALARM MODE** to **FLASHING**. In this way, the white light source flashes when the PIR module receives the alarm signal.

• **LIGHTING**

Select the **LIGHTING** mode, the embedded white light source turns on in poor light conditions automatically. You can set the **LIGHTING MODE** to **SOLID** or **FLASHING**.

- **SOLID**

The white light source turns on in poor lighting conditions.

FUNCTIONS	
WHITE LIGHT	◀ LIGHTING ▶
LIGHTING MODE	◀ SOLID ▶
PIR LEVEL	◀ 3 ▶
BACK	↵
EXIT	↵
SAVE & EXIT	↵

Figure 14, SOLID

- **FLASHING**

When you set the **LIGHTING MODE** to **FLASHING**, you can set the **TRIGGER MODE** to **CAMERA** or **DVR**.

The white light source flashes in poor lighting conditions when receiving the alarm signal.

* **TRIGGER MODE**

o **DVR**

Set the **TRIGGER MODE** to **DVR**. In this way, the alarm signal is sent from the DVR, and the camera works as an alarm detector in the process. Besides, the alarm type only supported by the DVR can also trigger the visible alarm in the camera.

FUNCTIONS	
WHITE LIGHT	◀ LIGHTING ▶
LIGHTING MODE	◀ FLASHING ▶
TRIGGER MODE	◀ CAMERA ▶
PIR LEVEL	◀ 3 ▶
BACK	↵
EXIT	↵
SAVE & EXIT	↵

Figure 15, FLASHING

- **CAMERA**

Set the **TRIGGER MODE** to **CAMERA**, the embedded PIR module sends the alarm signal to the visible alarm in the camera when the PIR module detects the alarm source.

- **OFF**

Select **OFF** to disable this function.

- **PIR LEVEL**

Adjust the sensitivity of the PIR module. The higher the value, the more sensitive the PIR module.

- **FACTORY DEFAULT**

Reset all the settings to the factory defaults.

- **EXIT**

Move the cursor to **EXIT** and click **Iris+** to exit the menu.

- **SAVE & EXIT**

Move the cursor to **SAVE & EXIT** and click **Iris+** to save the settings and exit the menu.