

HIKVISION®

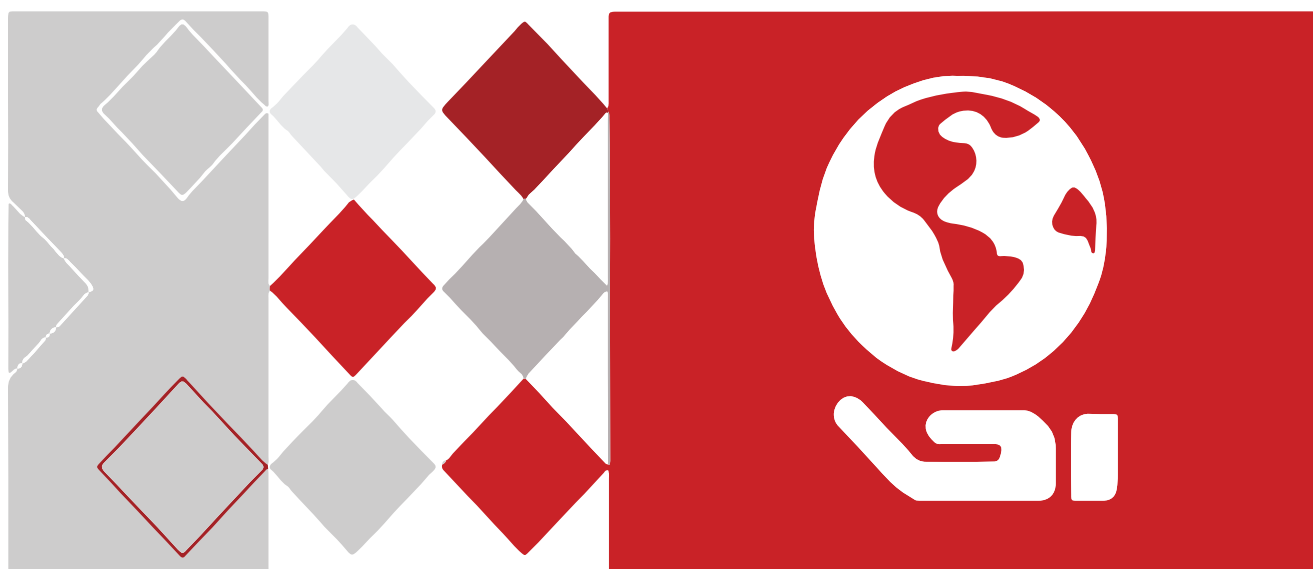

HD-TVI Speed Dome

DS-2AE7232TI-A

User Manual

© 2016-2019 Hangzhou Hikvision Digital Technology Co., Ltd.

This user manual is intended for users of the Hikvision DS-2AE7232TI-A HD-TVI Speed Dome. It includes instructions on how to use the product. The software embodied in the product is governed by the user license agreement covering that product.

About this Manual

This manual is subject to domestic and international copyright protection. Hangzhou Hikvision Digital Technology Co., Ltd. ("Hikvision") reserves all rights to this manual. This manual cannot be reproduced, changed, translated, or distributed, partially or wholly, by any means, without the prior written permission of Hikvision.

Trademarks

HIKVISION and other Hikvision marks are the property of Hikvision and are registered trademarks or the subject of applications for the same by Hikvision and/or its affiliates. Other trademarks mentioned in this manual are the properties of their respective owners. No right of license is given to use such trademarks without express permission.

Disclaimer

TO THE MAXIMUM EXTENT PERMITTED BY APPLICABLE LAW, HIKVISION MAKES NO WARRANTIES, EXPRESS OR IMPLIED, INCLUDING WITHOUT LIMITATION THE IMPLIED WARRANTIES OF MERCHANTABILITY AND FITNESS FOR A PARTICULAR PURPOSE, REGARDING THIS MANUAL. HIKVISION DOES NOT WARRANT, GUARANTEE, OR MAKE ANY REPRESENTATIONS REGARDING THE USE OF THE MANUAL, OR THE CORRECTNESS, ACCURACY, OR RELIABILITY OF INFORMATION CONTAINED HEREIN. YOUR USE OF THIS MANUAL AND ANY RELIANCE ON THIS MANUAL SHALL BE WHOLLY AT YOUR OWN RISK AND RESPONSIBILITY.

TO THE MAXIMUM EXTENT PERMITTED BY APPLICABLE LAW, IN NO EVENT WILL HIKVISION, ITS DIRECTORS, OFFICERS, EMPLOYEES, OR AGENTS BE LIABLE TO YOU FOR ANY SPECIAL, CONSEQUENTIAL, INCIDENTAL, OR INDIRECT DAMAGES, INCLUDING, AMONG OTHERS, DAMAGES FOR LOSS OF BUSINESS PROFITS, BUSINESS INTERRUPTION, SECURITY BREACHES, OR LOSS OF DATA OR DOCUMENTATION, IN CONNECTION WITH THE USE OF OR RELIANCE ON THIS MANUAL, EVEN IF HIKVISION HAS BEEN ADVISED OF THE POSSIBILITY OF SUCH DAMAGES.

SOME JURISDICTIONS DO NOT ALLOW THE EXCLUSION OR LIMITATION OF LIABILITY OR CERTAIN DAMAGES, SO SOME OR ALL OF THE ABOVE EXCLUSIONS OR LIMITATIONS MAY NOT APPLY TO YOU.

Support

Should you have any questions, please do not hesitate to contact your local dealer.

Thank you for purchasing our product. If there are any questions or requests, please do not hesitate to contact the dealer.

Regulatory Information

FCC Information

Please take attention that changes or modification not expressly approved by the party responsible for compliance could void the user's authority to operate the equipment.

FCC Compliance

This equipment has been tested and found to comply with the limits for a Class A digital device, pursuant to part 15 of the FCC Rules. These limits are designed to provide reasonable protection against harmful interference when the equipment is operated in a commercial environment. This equipment generates, uses, and can radiate radio frequency energy and, if not installed and used in accordance with the instruction manual, may cause harmful interference to radio communications. Operation of this equipment in a residential area is likely to cause harmful interference in which case the user will be required to correct the interference at his own expense.

FCC Conditions

This device complies with part 15 of the FCC Rules. Operation is subject to the following two conditions:

- This device may not cause harmful interference.
- This device must accept any interference received, including interference that may cause undesired operation.

EU Conformity Statement



This product and, if applicable, the supplied accessories, too, are marked with "CE" and comply therefore with the applicable harmonized European standards listed under the Low Voltage Directive 2014/35/EU, the EMC Directive 2014/30/EU, and the RoHS Directive 2011/65/EU.



2012/19/EU (WEEE Directive): Products marked with this symbol cannot be disposed of as unsorted municipal waste in the European Union. For proper recycling, return this product to your local supplier upon the purchase of equivalent new equipment, or dispose of it at designated collection points. For more information see: www.recyclethis.info.



2006/66/EC (Battery Directive): This product contains a battery that cannot be disposed of as unsorted municipal waste in the European Union. See the product documentation for specific battery information. The battery is marked with this symbol, which may include lettering to indicate cadmium (Cd), lead (Pb), or mercury (Hg). For proper recycling, return the battery to your supplier or to a designated collection point. For more information see: www.recyclethis.info.



Safety Instruction

These instructions are intended to ensure that the user can use the product correctly to avoid danger or property loss.

The precaution measure is divided into "Warnings" and "Cautions":

Warnings: Serious injury or death may be caused if any of these warnings are neglected.

Cautions: Injury or equipment damage may be caused if any of these cautions are neglected.

	
Warnings Follow these safeguards to prevent serious injury or death.	Cautions Follow these precautions to prevent potential injury or material damage.



Warnings:

- Adopt a power adapter that can meet the safety extra low voltage (SELV) standard. Refer to the specification manual for the standard of power adapter and the power consumption cannot be less than the required value.
- Do not connect several devices to one power adapter as an adapter overload may cause over-heating and can be a fire hazard.
- If the product is installed on a wall or ceiling, the device should be firmly fixed.
- To reduce the risk of fire or electrical shock, do not expose an indoor product to rain or moisture.
- This installation should be made by a qualified service person and should conform to all local codes.
- Install blackout equipment into the power supply circuit to address supply interruption.
- If the product does not work properly, please contact your dealer or the nearest service center. Never attempt to disassemble the product yourself. (We shall not assume any responsibility for problems caused by unauthorized repair or maintenance.)



Cautions:

- Make sure the power supply voltage is correct before using the product.
- Do not drop the product or subject it to physical shock. Do not install the product on vibratory surface or places.

- Do not expose it to high electromagnetic radiating environment.
- Do not aim the lens at a strong light such as the sun or an incandescent lamp. The strong light can cause fatal damage to the product.
- The sensor may be burned out by a laser beam, so when any laser equipment is being used, make sure that the surface of the sensor is not exposed to the laser beam.
- Do not place the dome in extremely hot, cold, dusty, or damp locations, otherwise fire or electrical shock may occur. Refer to the Specification for operating temperature details.
- To avoid heat accumulation, good ventilation is required for a proper operating environment.
- When shipping, pack the product in its original packing.
- Use the provided glove when opening the product cover. Do not touch the product cover with fingers directly, because the acidic sweat of the fingers may erode the surface coating of the product cover.
- Use a soft and dry cloth when cleaning inside and outside surfaces of the product cover. Do not use alkaline detergents.
- Improper use or replacement of the battery may result in explosion hazard. Please use the manufacturer's recommended battery type.

Table of Contents

About this Manual	2
Trademarks.....	2
Disclaimer	2
Support	2
Regulatory Information.....	3
FCC Information	3
FCC Compliance.....	3
FCC Conditions	3
EU Conformity Statement	3
Safety Instruction	4
1 Overview.....	8
Description	8
Functions.....	8
2 Getting Started.....	10
System-Defined Presets	11
On-Screen Displays.....	11
3 Menu Operation	12
Accessing and Operating the Menu.....	13
Configuring System Information	14
Dome Address Settings	15
Soft Baud Rate Settings	15
Pelco Checksum.....	16
System Time Configuration	16
Zero Angle Configuration.....	16
Display Settings	16
Protocol and RS-485 Settings.....	18
Power Memory Settings	18
Hikvision-C (Coaxitron) Control	18
Configuring Image Parameters.....	18
Configuring the Focus Settings	19
Configuring the Zoom Settings	20
Configuring the IR Cut Filter	20
Configuring the Sharpness Level.....	21
Configuring the BLC and WDR.....	21

Configuring the Iris, Gain, and Shutter Speed	21
Setting the Iris Value	21
Configuring Exposure Compensation	22
Configuring White Balance	22
Configuring the Image Flip	22
Configuring the Focus Limit	22
Configuring the Noise Reduction	23
Configuring PTZ Parameters	26
Setting Limits	28
Elevation Set	28
Configuring and Handling Alarms	37
Other	40
4 Appendix	41
Appendix 1 Lightning and Surge Protection	41
Appendix 2 RS-485 Bus Connection	42
Appendix 3 24 VAC Wire Gauge and Transmission Distance	45
Appendix 4 Wire Gauge Standards	45

1 Overview

Description

Integrated with a built-in pan/tilt unit, the speed dome features highly sensitive response and reliable performance. The speed dome can be adopted in various surveillance fields with its full-integral functions and features such as corridor, large venue, meeting room, station, neighborhoods, etc.

Functions

NOTE: Functions vary by speed dome model.

- **Coaxial Control:** The speed dome with a specified DVR or controller can be sent the control signals via coaxial cable (BNC cable).
- **High-Definition Output:** The output image resolution can be up to 1080p.
- **Limits:** The dome can be programmed to move within the limits (left/right, up/down).
- **Self-Adaptive Protocol:** While using RS-485 control, the speed dome is compatible with PELCO-D, PELCO-P, PRIVATE-Code, etc., and is capable of being self-adaptive to these protocols without selecting a protocol by DIP switch settings. While using coaxial control, the speed dome is self-adaptive to PELCO-D and PRIVATE-Code protocols.
- **Keyboard Control:** The pan/tilt movement and zoom actions of dome can be controlled by the control keyboard, DVR, matrix, etc.
- **Scan Modes:** The dome provides five scan modes: auto scan, tilt scan, and panorama scan.
- **Preset Freezing:** This feature freezes the scene on the monitor when the dome is moving to a preset. This allows for smooth transition from one preset scene to another. It also guarantees that masked area will not be revealed when the dome is moving to a preset.
- **Presets:** A preset is a predefined image position. When the preset is called, the dome will automatically move to the defined position. The presets can be added, modified, deleted, and called.
- **Label Display:** The on-screen label of the preset title, PT display, zoom, and time can be displayed on the monitor.
- **Auto Flips:** In manual tracking mode, when a target object goes directly beneath the dome, the video will automatically flip 180 degrees horizontally to maintain tracking continuity. This function can also be realized by auto mirror image depending on camera model.
- **Privacy Mask:** This function allows you to block or mask certain areas of a scene, to prevent personal privacy from recording or live viewing. A masked area will move with the pan and tilt functions and automatically adjust in size as the lens zooms telephoto and wide.

- **3D Positioning:** In the client software, use the left mouse key to click on the desired position in the video image, and drag a rectangle area in the lower right direction, then the dome system will move the position to the center and allow the rectangle area to zoom in. Use the left mouse key to drag a rectangle area in the upper left direction to move the position to the center and allow the rectangle area to zoom out.
- **Proportional Pan/Tilt:** Proportional pan/tilt automatically reduces or increases the pan and tilt speeds according to the amount of zoom. At telephoto zoom settings, the pan and tilt speeds will be slower than at wide zoom settings. This keeps the image from moving too fast on the live view image when there is a large amount of zoom.
- **Auto Focus:** The auto focus enables the camera to focus automatically to maintain clear video images.
- **Day/Night Auto Switch:** The speed domes deliver color images during the day. As light diminishes at night, the speed domes switch to night mode and deliver black and white images with high quality.
- **Slow Shutter:** In slow shutter mode, the shutter speed will automatically slow down in low illumination conditions to maintain clear video images by increasing the exposure time. This feature can be enabled or disabled.
- **Backlight Compensation (BLC):** If you focus on an object against strong backlight, the object will be too dark to be seen clearly. The BLC (Backlight Compensation) function can compensate light to the object in the front to make it clear, but this causes the over-exposure of the background where the light is strong.
- **Wide Dynamic Range (WDR):** The wide dynamic range (WDR) function helps the camera provide clear images even under back light circumstances. When there are both very bright and very dark areas simultaneously in the field of view, WDR balances the brightness level of the whole image and provides clear images with details.
- **White Balance (WB):** White balance can remove unrealistic color casts. White balance is the white rendition function of the camera to adjust the color temperature according to the environment automatically.
- **Patrol:** A patrol is a memorized series of pre-defined presets. The scanning speed between two presets and the dwell time at the preset are programmable.
- **Pattern:** A pattern is a memorized series of pan, tilt, zoom, and preset functions. By default, the focus and iris are in auto status during the time the pattern is being memorized.
- **Power Off Memory:** The dome supports power off memory capability with a predefined resume time. It allows the dome to resume its previous position once power is restored.
- **Time Task:** A time task is a preconfigured action that can be performed automatically at a specific date and time. Programmable actions include: pan scan, patrol 1-8, pattern 1-4, preset 1-8, panorama scan, tilt scan, day, night, and none.
- **Park Action:** This feature allows the dome to start a predefined action automatically after a period of inactivity.

2 Getting Started

- **Power-up Action:** After the speed dome is powered on, it will perform a series of self-test actions. It runs pan checking first, then tilt checking, and camera checking last. After the power-up actions, the system information will be displayed for 120 s on the live view screen, as shown below.

	XX-XXXXX-XX
SN	XXXXXXXX
ADDRESS	0
COM FORMAT	2400,8,1
PROTOCOL	AUTO MATCH
FIRMWARE	X.XX
HARDWARE	X.XX
BUILD DATE	XX XX XX
TILT SUCCESS	
PAN CHECK ERR	
SMART VERSION	VX.XX

Figure 1, System Information

Table 2-1 Descriptions of the System Information

System Info	Description
SN	The serial no. of the speed dome, which is unique
ADDRESS	The default communication address of the speed dome
COM Format	The communication settings of the speed dome, including baud rate (2400 by default), data bits (8 by default), and stop bits (1 by default)
PROTOCOL	Communication with other devices
FIRMWARE	Firmware version
HARDWARE	Hardware version
BUILD DATE	Date when the software program was compiled

NOTES:

- You must configure the camera’s address and baud rate to be the same as the control devices.
- The speed dome is self-adaptive to the PELCO-D, PELCO-P, and PRIVATE-Code protocols.
- **Basic Operations:** You can operate the camera by using a control device (e.g., control keyboard, DVR, DVS, etc.). In this manual, accessing the speed dome via a Web browser will be used as an example.
- **Panning and Tilting:** Click the direction buttons to control the speed dome pan and tilt movement.
- **Zooming:** Click the **ZOOM+** and **ZOOM-** buttons to control the zooming.
- **Focusing:** Click the **FOCUS+** and **FOCUS-** buttons to adjust the focus.
- **Iris:** Click the **IRIS+** and **IRIS-** buttons to adjust the iris.

System-Defined Presets

Purpose:

The section lists the system-defined presets with special functions. These presets cannot be edited, but can be called only through a control device, e.g. a DVS or Web browser. To call the system-defined presets remotely, choose the preset number from the list in the PTZ control panel. Refer to table below for details.

EXAMPLE: Preset 99 is "Start auto scan." If you call preset 99, the speed dome starts auto scan.

Table 2-2 System-Defined Presets

Preset No.	Function	Preset No.	Function
33	Auto-flip	92	Enable limits
34	Return to home position	93	Set manual limits
35	Patrol 1	94	Remote reboot
36	Patrol 2	95	Access main menu
37	Patrol 3	96	Stop scanning
38	Patrol 4	97	Start random scanning
39	IR cut filter in	98	Start frame scanning
40	IR cut filter out	99	Start auto scanning
41	Pattern 1	100	Start tilt scanning
42	Pattern 2	101	Start panorama scanning
43	Pattern 3	102	Patrol 5
44	Pattern 4	103	Patrol 6
46	Enable fast patrol	104	Patrol 7
90	Enable wiper	105	Patrol 8

On-Screen Displays

The speed dome supports the following on-screen displays:

- **Zoom Ratio:** Identifies the amount of magnification. The format is Zxxx. xxx is the zoom amount.
- **PT Angle:** Displays panning and tilting direction, in the format NExxx/Txxx. NExxx indicates degrees in the northeast direction, while Txxx indicates degrees in tilt position.
- **Alarm:** When an alarm is triggered, the corresponding information will be displayed.
- **Time:** Displayed as Day/Month/Year/Day of Week/Hour/Minute. It supports 24-hour time system.
- **Preset Label:** After you call the configured preset, the preset number is displayed if the lens moves to the location for which you've set a preset.
- **Zone:** Displays the zone title.
- **Address:** Displays the speed dome's address.

- **Error Rate:** Displays the speed dome's error rate.
- **Fan and Heat:** Displays the speed dome's heat information.

3 Menu Operation

NOTE:

- The operation interface of various speed domes may differ. Please refer to the actual operation interface.
- You can click the left and right direction buttons in the PTZ control panel via the DVR Web browser to enter the next page or return to the previous page of the submenu if more than one page is available.

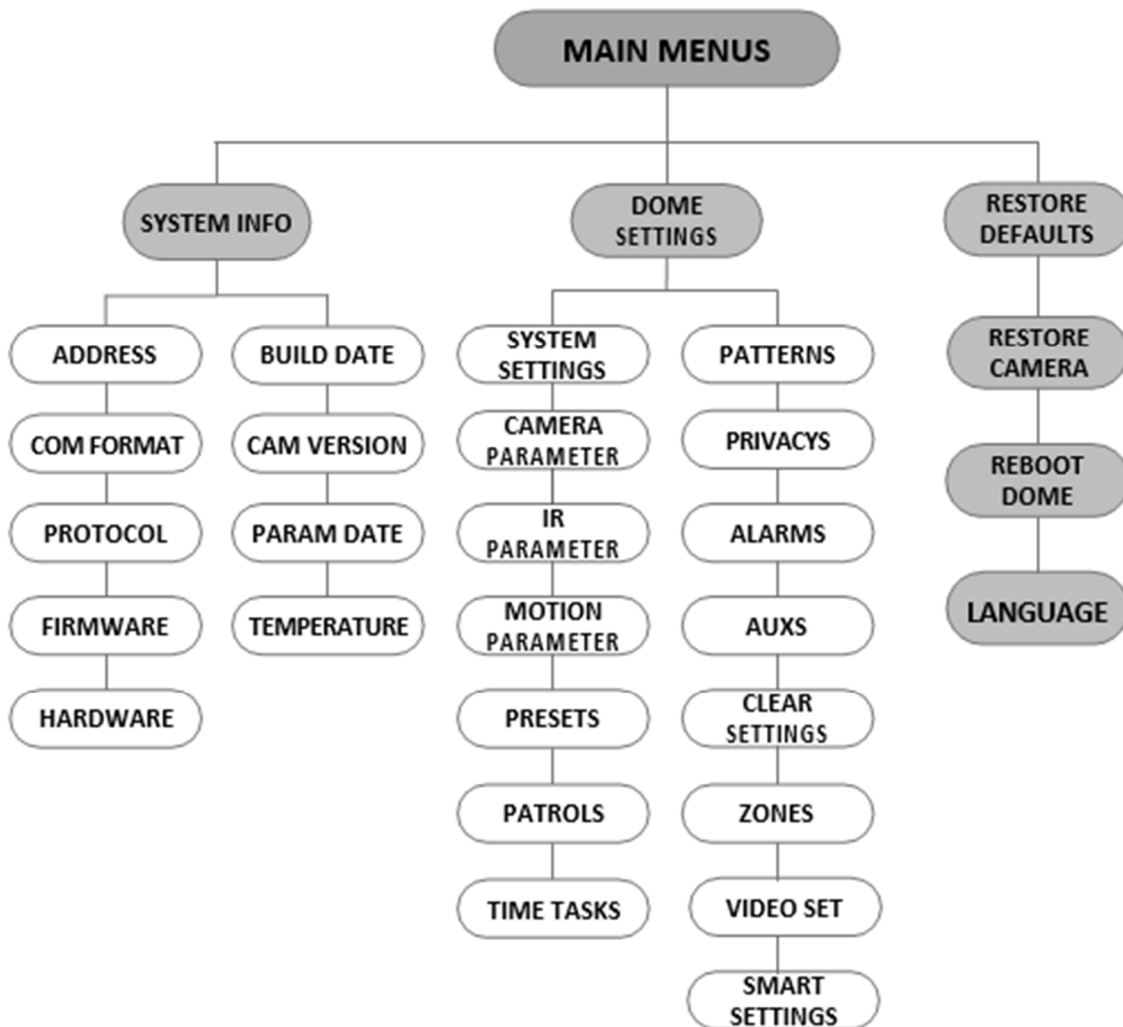

Figure 2, Menu Structure

Before you start:

You can operate the speed dome by using the on-screen display menu remotely by connecting to a DVR or a DVS (encoder).

Examples of Entering Speed Dome Menu:

- Enter the menu by pressing buttons: **PTZ** -> **REC** -> **9** -> **5** on the front panel of the DVR.
- Enter the menu by pressing buttons: **CALL** -> **9** -> **5** -> **ENTER** on the keyboard.
- Enter the menu via the DVR/DVS Web browser.

Menu operations via the DVR's Web browser will be taken as an example in this chapter.

Accessing and Operating the Menu

To Enter the Main Menu

1. Connect the speed dome's video and RS-485 cables to a DVR.
2. Visit the DVR via a Web browser.
3. View the live video of the speed dome.
4. For PELCO-P/D and other private PTZ protocols, call preset 95 from the preset list in the DVR's PTZ control panel.

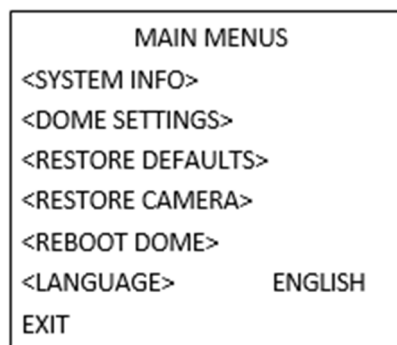

Figure 3, Main Menu

To Move the Cursor and Operate the Menu

- **Move the Cursor Up/Down:** On the live view page of the Web browser, click up/down direction buttons or **FOCUS+** and **FOCUS-** buttons in the PTZ control panel to move the cursor up and down.
- **Enter/Exit:** On the live view page of the Web browser, click **IRIS+** to enter a submenu; move the cursor to **Exit** and click **IRIS+** to exit.

To Change a Parameter Value

1. Move the cursor to the target item and click the **IRIS+** button. The cursor shape will change.

2. Click the up/down or left/right buttons in the PTZ control panel to choose a value from the list.
3. Press **IRIS+** to confirm the change or click **IRIS-** to cancel and restore the original value. The cursor shape will again change.

Configuring System Information

Checking System Information

Purpose:

The system information menu displays the current system information of the speed dome, including model, address, protocol, etc. The information shown on this submenu is similar to the system information shown after the power-up action. Please refer to *Section 2.1* for more details.

1. Enter the system information display menu: **MAIN MENUS > SYSTEM INFO.**

SYS INFO		SYS INFO	
ADDRESS	XX-XXXXX-X 0	CAM VERSION	X.XX
COM FORMAT	2400,8,1	PARAM DATE	X XX XX
PROTOCOL	SELF ADAPTIVE	TEMPERATURE	38
VERSION	1.00	TRACK	X.XX
HARDVERSION	1.00	TRACKBUILDTIM	161130
BUILD DATE	16 11 04		
BACK	EXIT	BACK	EXIT

Figure 4, System Information

NOTE:

- Information on this menu cannot be edited.
- The temperature refers to the internal temperature of the speed dome.

Configuring System Parameters

Purpose:

You can check and also edit the system information of software address, baud rate, system time, etc. on the system information settings menu.

1. Go to **MAIN MENUS > DOME SETTINGS > SYSTEM INFO SETTINGS.**

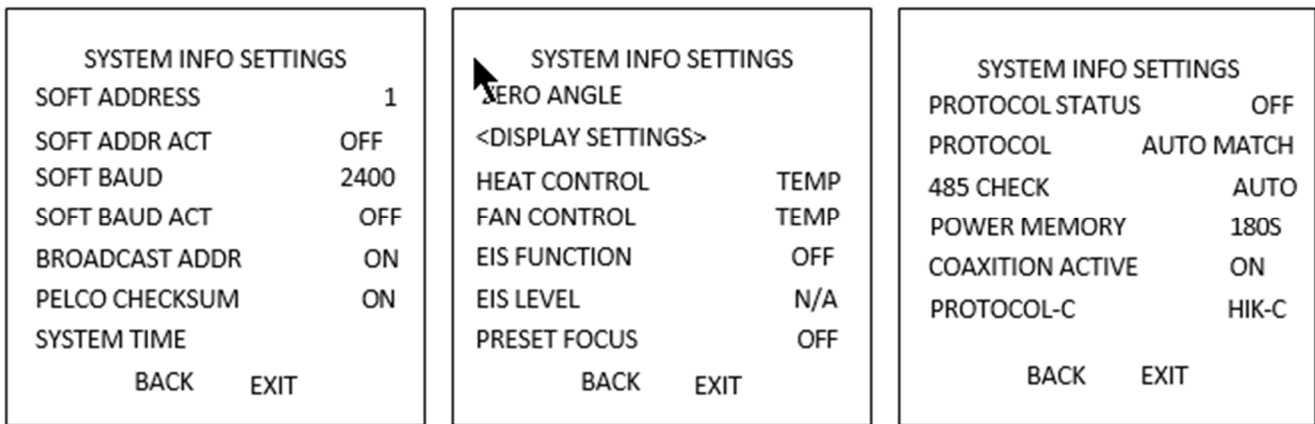

Figure 5, System Information Settings

NOTE: You can click the left and right direction buttons in the PTZ control panel via the encoder Web browser to enter the next page and return to the previous page of the submenu if more than one page is available.

Dome Address Settings

To Set the Soft Address of the Speed Dome

If **SET SOFT ADDR ACT** is set to **ON**, the soft address is the valid address for connecting the speed dome. The selectable soft address ranges from 1 to 255.

If **SET SOFT ADDR ACT** is set to **OFF**, the hard address set by the DIP switch is the valid speed dome address.

NOTES:

- Before you set the soft address of the speed dome, you need to confirm that it is within the control range of the control device (e.g., the DVR).
- After you enable/disable the soft address, the speed dome will reboot automatically to activate the settings.

To Set the Broadcast Address of the Speed Dome

When the **BROADCAST ADDR** is set to **ON**, the control device with address 0 is capable of controlling all domes connected to it.

Soft Baud Rate Settings

If the **SOFT BAUD** is set to **ON**, the soft baud rate is the valid baud rate for the speed dome, with 2400, 4800, 9600, and 19200 selectable.

If the **SOFT BAUD** is set to **OFF**, the baud rate is set by the DIP switch.

NOTE: After you enable/disable the soft baud rate, the speed dome will reboot automatically to activate the settings.

Pelco Checksum

The PELCO CHECKSUM is used for Pelco-P and Pelco-D protocols. If the video turns black or is uncontrollable, you can set the **PELCO CHECKSUM** to **ON** to improve the video quality.

System Time Configuration

1. Move the cursor to **SYS TIME** using the direction buttons, and click **IRIS+** to enter.
2. Click the left/right direction buttons to position the cursor on the specific item (year/month/day or hour/minute/second) of which you want to change the value.
3. Click the up/down direction buttons to increase/decrease the value.
4. Click **IRIS+** button to confirm the settings and exit.

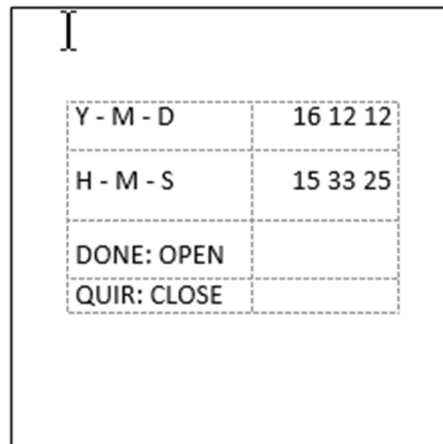

Figure 6, Set the System Time

Zero Angle Configuration

Purpose:

You can define the zero angle of the speed dome on the **ZERO ANGLE** submenu.

1. Move the cursor to **ZERO ANGLE** using the direction buttons and click **IRIS+** to enter.
2. Click the left/right/up/down direction buttons to adjust the monitor angle of the speed dome.
3. Click **IRIS+** button to confirm the settings and exit.

Display Settings

Purpose:

You can enable or disable the on-screen display of PTZ movements, alarms, time, preset, zone, address, error rate, fan/heat show, etc.

1. Move the cursor to **DISPLAY SETTINGS** using the direction buttons, and click **IRIS+** to enter.

2. Move the cursor to the target item and click **IRIS+**, and click up/down direction buttons to set each display mode to **ON** or **OFF**, and set each display time to 2 seconds, 5 seconds, or 10 seconds.
3. Click **IRIS+** button to confirm the settings.

NOTE: If you enable the OSD (On-Screen Display) for both ZOOM SHOW and P/T ANGLE, when calling a preset, the preset no. will display on the screen until the preset scene passes.

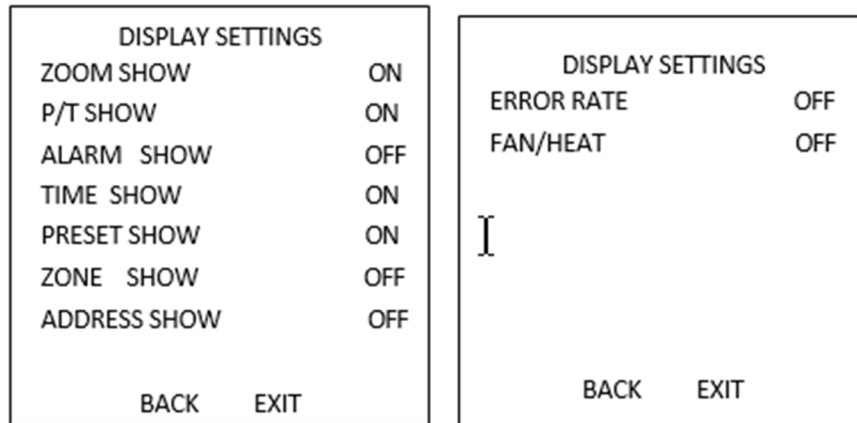

Figure 7, Display Settings

The speed dome shows the viewing direction when you manually control and rotate it.

Table 1-1 Viewing Direction Display

Display	N	NE	E	SE	S	SW	W	NW
Indication	North	Northeast	East	Southeast	South	Southwest	West	Northwest

NOTE: The north direction refers to the angle zero.

- **Heat Parameter Configuration:** You can set the **HEAT CONTROL** as **TEMP** (controlled by the temperature), **ON** or **OFF**.
- **Fan Parameter Configuration:** You can set the **FAN CONTROL** to **TEMP** (controlled by the temperature), **ON**, or **OFF**.
- **EIS (Electronic Image Stabilization) Configuration:** You can set the **EIS FUNCTION** to **ON** or **OFF**, and set the **EIS LEVEL** to **0** to **3**.

NOTE: The selectable EIS level varies by camera model.

- **Preset Direct Focus:** You can set the preset direct focus function to **ON/OFF** on the **PRESET DFOCUS** submenu.

Protocol and RS-485 Settings

1. Select the protocol. Set the protocol on the **PROTOCOL** submenu to **AUTO MATCH**, **PELCO-P**, **PELCO-D**, or **HIKVISION**. **AUTO MATCH** is protocol self-adaptive.
2. Set the protocol status. Set the **PROTOCOL STATUS** to **ON** to enable the user-defined protocol.
3. Enable the RS-485 configuration diagnosis. You can set **485 CHECK** to **ON** or **AUTO** for automatic RS-485 configuration diagnosis. If the configuration is incorrect, an alert will be received. If you set the value to **AUTO**, it will automatically stop the diagnosis when no errors exist.

Power Memory Settings

The dome can resume its previous PTZ status after it restarts from power off when it stops at a position longer than the predefined time. You can set the memory time to 10s, 30s, 60s, 180s, and 300s.

Hikvision-C (Coaxitron) Control

The Coaxial Transmission function can be enabled to transmit the RS-485 signal along with the video signal via the BNC cable. If the connected encoding device supports coaxial transmission as well, the RS-485 cable will not be necessary.

1. Enable the Coaxial Control function by setting the **COAXITRON ACTIVE** option to **ON**.
2. Select the Coaxial Control protocol to **HIK-C**.

NOTE: Set the transmission protocol of the connected encoding device to the same value as the speed dome to support the coaxial transmission.

Configuring Image Parameters

Configuring Camera Parameters

Purpose:

You can set the camera parameters including focus, shutter speed, iris, etc. Enter the camera parameters settings menu: **MAIN MENUS > DOME SETTINGS > CAMERA PARAMETER**.

CAMERA		CAMERA	
FOCUS	AF	BLC/WDR	OFF
ZOOM LIMIT	22	BLC LEVEL	N/A
ZOOM SPEED	HIGH	AE MODE	AUTO
SLOW SHUTTER	ON	IRIS	10
IRCUT FILTER	AUTO	SHUTTER	50
D/N LEVEL	1	GAIN	N/A
SHARPNESS	7	EXPOSURE COMP	7
BACK	EXIT	BACK	EXIT

CAMERA		CAMERA		CAMERA	
WHITE BALAN	ATW	WIDE LIMIT	2.0	GAIN LIMIT	15
RED	64	CHROMA SUPPRESS	1	DEFOG	OFF
BLUE	64	SATURATION	1	INIT LENS	OFF
IMAGE FLIP	OFF	CONTRAST	OFF		
FOCUS LIMIT	1M	SCENE MODE	INDOOR		
2D DNR	1	HLC	ON		
3D DNR	2	SHARPNESS COMP	15		
BACK	EXIT	BACK	EXIT	BACK	EXIT

Figure 8, Camera Settings

Configuring the Focus Settings

Setting the Focus Mode

1. Move the cursor to **FOCUS** using the direction buttons and click **IRIS+** to enter.
2. Click up/down direction buttons to set the focus mode to **AF**, **MF**, or **HAF**.
 - **AF (Auto-Focus):** The lens remains in focus during PTZ movements.
 - **MF (Manual Focus):** You need to adjust the focus with **Focus+** and **Focus-** buttons manually.
 - **HAF (Half-Auto Focus):** The speed dome focuses automatically only once after panning, tilting, and zooming.
3. Click the **IRIS+** button to save the settings.

Setting the Focus Limit

Purpose:

This function limits the minimum focus distance. You can configure the focus limit longer when the target is at a distance, to avoid the speed dome focusing on the objects close to it; or configure the focus limit shorter when the target is near the speed dome, and avoid it focusing on the father objects.

1. You can set the **FOCUS LIMIT** to **1 CM, 30 CM, 1M, 3M, 5M, and AUTO** to make sure that the speed dome focuses on the target.

NOTE: The focus limit value varies by speed dome model.

Configuring the Zoom Settings

Setting the Zoom Limit

Purpose:

Zoom limit is a user-defined limitation of the zoom amount (zoom amount = optical zoom × digital zoom). If you set the zoom limit to the minimum value, the digital zoom will be invalid and the optical zoom will reach the maximum value; if you set the zoom limit smaller, the digital zoom will be enabled.

1. Move the cursor to **ZOOM LIMIT** using the direction buttons, and click **IRIS+** to enter.
2. Click up/down direction buttons to choose the limit from 23, 46, 92, 184, and 368.
3. Click **IRIS+** button to confirm.

NOTE: If you set the ZOOM LIMIT minimum value to 22, the digital zoom function will be disabled and the optical zoom function will be at its maximum value.

Configuring the Zoom Speed

Purpose:

You can define the speed at which the lens changes from full wide zoom to the optical zoom.

1. Move the cursor to **ZOOM SPEED** using the direction buttons, and click **IRIS+** to enter.
2. Click up/down direction buttons to choose the speed from **HIGH** (default), **MEDUIM**, and **LOW**.
3. Click **IRIS+** button to confirm.

Configuring the IR Cut Filter

There are two parameters available for IR cut filter configuration.

- **IR Cut Filter** – Can be set to **AUTO, DAY, or NIGHT**.
 - **AUTO:** The speed dome will automatically switch between black and white mode (NIGHT) and Color mode (DAY) based on the lighting conditions. Auto is the default mode.
 - **NIGHT (B/W):** You can switch the IR cut filter to black and white mode to increase the lens sensitivity in low light conditions.
 - **DAY (Color):** You can switch the IR cut filter to DAY mode in normal lighting conditions.

NOTES:

- You can call preset 39 to set the IR cut filter mode to **DAY** mode and call preset 40 to set it to **NIGHT** mode.

- The **IR CUT FILTER** cannot be configured unless the IR light is turned off.
- **D/N LEVEL.** The D/N level is the light level for the auto D/N mode switch. As a threshold, the IR cut filter switches between DAY and NIGHT when the light condition reaches the user-defined D/N level.

NOTE: The D/N level option varies by camera model. Some models do not support user-defined D/N level.

Configuring the Sharpness Level

The sharpness function can increase the image gain and sharpen edges to enhance details. You can set the **SHARPNESS** level from 0 to 15.

Configuring the BLC and WDR

BLC/WDR and **BLC LEVEL** varies by camera model. Some models don't support user-defined BLC level.

- **BLC/WDR.** You can set the value to **ON** or **OFF** to enable or disable the functions.
- **BLC LEVEL.** You can manually adjust the backlight compensation level.

Configuring the Iris, Gain, and Shutter Speed

Set the Exposure Mode

Purpose:

AE mode defines the priority of iris, shutter, and gain while the speed dome adjusting the brightness of the live view. You can change the mode on **AE MODE** submenu.

- **AUTO:** Auto iris, auto shutter and auto gain. The speed dome adjusts the values automatically responding to the lighting conditions. It is the default mode.
- **IRIS:** User-defined iris value, auto shutter, and auto gain. It is the iris-priority mode. Define the iris value according to related content in this section if you choose **IRIS** mode.
- **SHUTTER:** User-defined shutter speed, auto iris, and auto gain. It is the shutter-priority mode. Please define the shutter speed according to related content in this section if you choose **SHUTTER** mode.
- **MANUAL:** User-defined iris, gain, and shutter. Please define the iris value, gain value, and shutter speed according to related content in this section if you choose **MANUAL** mode.

Setting the Iris Value

The **IRIS** value measures the amount of light entering the lens. You can set the iris value from 0 to 17 in response to the changing light conditions. The iris is fully closed at value 0 and fully open at value 17.

Setting the Gain

- **Gain Value.** Indicates amplification degree of the original image signal. You can set value from 0 to 15.
- **Gain Limit.** The higher the gain value, the more noise will appear in the image. You can set the maximum user configurable gain value from 0 to 15 to limit the gain range and control the noise in the image.

NOTE: You need to change the IR CUT FILTER to DAY or NIGHT mode and set the AE MODE to MANUAL before you adjust the gain value.

Set the Shutter

Purpose:

The electronic shutter speed controls the amount of light entering the lens in a unit of time (a second). You can manually configure the shutter speed for the speed dome, and you can also enable the slow shutter function for low lighting circumstances.

- **Shutter Speed.** The greater the **SHUTTER** value (the faster the shutter speed), the less light will enter per second, and the darker the image will be. You can set the value to 1, 2, 4, 8, 15, 30, 50, 125, 180, 250, 500, 1000, 2000, 4000, or 10000.

NOTE: The value of X indicates that the shutter speed is 1/X second. If you set the SHUTTER value bigger (shutter speed is faster), the amount of light entering per second will be lower, and the image will be darker.

- **Slow Shutter.** Set **SLOW SHUTTER** to **ON** so that the shutter speed will automatically slow down to extend exposure time under low lighting circumstances to obtain a clearer image.

Configuring Exposure Compensation

You can set the **EXPOSURE COMP** value from 0 to 14. The default value is 7. You can adjust this value to increase the brightness of the image.

Configuring White Balance

You can set **WHITE BALAN** as **HAUTO**, **AUTO**, **INDOOR**, **OUTDOOR**, **SELFDEF** (self-defined), **ATW** (auto-tracking), and **HAUTO** (half-auto).

- **AUTO:** The dome retains color balance automatically according to the current color temperature.
- **INDOOR, OUTDOOR:** These two modes are for indoor use and outdoor use respectively.
- **SELFDEF:** In this mode, you can adjust the color temperature manually to meet your own demand.

NOTE: In **SELFDEF** mode, you need to adjust the **RED** and **BLUE** values manually.

- **ATW:** In auto-tracking mode, white balance is continuously being adjusted in real time according to the color temperature of the scene illumination.
- **HAUTO:** Selecting this mode, the viewed image retains color balance automatically according to the current color temperature.

Configuring the Image Flip

With the **IMAGE FLIP** function on, the image will be flipped diagonally along its central axis, shown as a mirror reflection of the image.

Configuring the Focus Limit

AUTO, **1 CM**, **1 M**, **3 M**, **5 M**, and **20 M** are selectable in **FOCUS LIMIT**. When set to **AUTO**, the focus limit automatically adjusts according to the zoom limit.

Configuring the Noise Reduction

To reduce the image noise, you can set the value of **2D DNR** and **3D DNR** respectively. The greater the value, the less noise will be in a low illumination environment. You can disable the function by turning the value to **OFF**.

Configuring the Image Quality

- **Wide Limit:** Set the value of **WIDE LIMIT** to limit the minimum zoom of the lens with **1.0, 1.1, 1.2, 1.3, 1.5, 1.8, and 2.0** available.

NOTE: The **Wide Limit** function is supported by certain speed dome models.

- **Chroma Suppress:** Set the Chroma suppress value from 1 to 3 to suppress the color noise so as to get a clear and high-quality image in a low luminance environment.

NOTE: The **Chroma Suppress** function is supported by certain speed dome models.

- **Saturation:** Saturation value from 0 to 7 indicates the brightness of the color. The higher the saturation, the brighter the color.

NOTE: The saturation function is supported by certain speed dome models.

- **Scene Mode:** Set the scene mode to **INDOOR** or **OUTDOOR**, and the default image settings will be changed according to the selected scene mode.

- **Contrast:** Contrast is the degree of difference between the darker and lighter parts of the image.

NOTE: The contrast function is supported by certain camera models.

- **HLC:** Set the value of **HLC** to brighten the darker area and weaken the highlight area of the image. The greater the value, the stronger the effect will be.

NOTE: The HLC function is supported by certain camera models.

- **Sharpness Compensation:** Set the **SHARPNESS COMP** value from 0 to 15 to automatically adjust the image sharpness to get a clear image. The greater the value, the stronger the effect.

- **Defog Parameters:** When there is fog in the image, you can enable the Defog function to get a clear image.

- **Lens Initialization:** You can turn **INIT LENS** on to trigger a spontaneous lens initiation to ensure normal operation.

Configuring Privacy Mask

Purpose:

Focus Limit enables you to cover certain areas on the live video from being live viewed and recorded. The masked areas can move with the panning/tilting movements and automatically adjust the size as the lens zooms in/out.

1. Move the cursor to enter the privacy mask configuration submenu: **MAIN MENUS > DOME SETTINGS > PRIVACY**

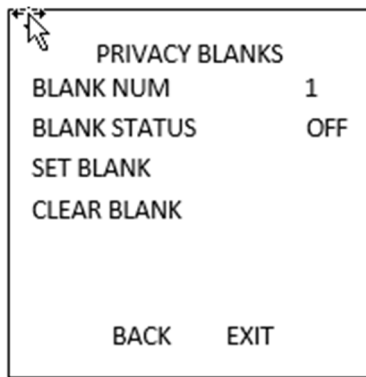

Figure 9, Privacy Blank Configuration Menu

2. Choose the privacy blank number:
 - A. Move the cursor to **BLANK NUM.** and click **IRIS+** to enter the editing mode.
 - B. Click the up and down direction buttons to select a mask number for configuration.
 - C. Click **IRIS+** again to confirm and exit the editing mode.

NOTE: The configurable privacy blank number varies by camera model.

3. Configure the position and size of the privacy blank.
 - A. Move the cursor to **SET BLANK** and click the **IRIS+** button to enter editing mode as shown in the following figure. You can see the privacy blank on the live window.

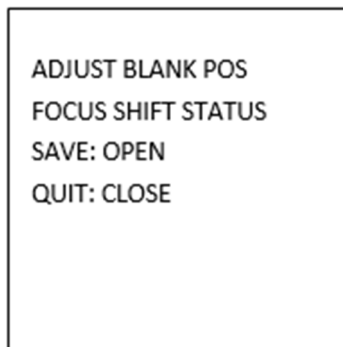

Figure 10, Set the Privacy Mask

- B. You can see *ADJUST BLANK POS* message on the screen. Click the direction buttons to adjust the position of the privacy blank to the designed scene.
- C. Click the **FOCUS+** button, and you can see *ADJUST BLANK SIZE* message on the screen. Click the up/down buttons to increase/decrease the height of the mask and click right/left buttons to increase/decrease the width of the mask. Click the **IRIS+** button to save the settings and return to the previous menu and you can see the mask turn to gray.

- D. To modify the configured mask, click the **IRIS+** button to enter the **SET BLANK** menu and click the **IRIS+** button again to edit focus limit.

NOTE: The tilt range for configuring the privacy blanks is from -15° to 60°.

4. Enable or disable the privacy blank function.

- A. Move the cursor to **BLANK STATUS**. Click the **IRIS+** button to enter editing mode and click the up and down direction buttons to set it **ON** or **OFF**.

NOTE: If no privacy blank has been configured, you cannot set the status to **ON**.

- B. Delete the privacy blank.

NOTE: You can enter the **CLEAR BLANK** menu to delete all configured privacy blanks.

Configuring Output Standard

Purpose:

The video output standard, including resolution and frame rate, can be changed according to the actual requirement.

1. Move the cursor to enter the Video Settings submenu: **MAIN MENU > DOME SETTINGS > VIDEO SET**.
2. Move the cursor to **VIDEO STD** and click **IRIS+** to enter the editing mode.
3. Click the up and down direction buttons to select a desired video standard.
4. Click **IRIS+** again to confirm and exit the editing mode.

Configuring IR Parameters

NOTE: The IR parameter settings are supported by IR speed domes only.

Purpose:

You can configure the IR parameters including the IR sensitivity, n/m LED current, far LED current, reference zoom, and LED control, fan control, switch delay, smart IR, etc.

1. Enter the LED parameter submenu: **MAIN MENU > DOME SETTINGS > IR PARAMETER**.

IR PARAMETER	
IR SENSITIVITY	MEDIUM
N/M LED CURRENT	8
FAR LED CURRENT	8
REFERENCE ZOOM	2
LED CONTROL	ICR
SWITCH DELAY(S)	2
SMART IR	0
BACK EXIT	

Figure 11, IR Settings

2. Set the IR LED sensitivity. This sets how low the ambient light must be to activate the IR LED. You can set the **SENSITIVITY** to **HIGH** (activates with a high level of ambient light), **MEDIUM** (activates with a medium level of ambient light), or **LOW** (activates with a low level of ambient light).
3. Set the electricity level of the IR LED. The **N/M LED CURRENT** and the **FAR LED CURRENT** refer to the electricity level of the near/middle IR LED and far IR LED correspondingly. You can set the near/far LED current and the far LED current to **1 to 10**.
4. Set the parameters for reference zoom. The value of **REFERENCE ZOOM** can be adjusted from 2 to 10.
5. Set the parameters of LED control. LED control can be set to **ALL ON** (enable all the IR LED), **FAR ON** (enable far-distance IR LED), **NEAR ON** (enable near/medium-distance IR LED), **AUTO** (enable IR LED automatically according to the environment illumination), **ICR** (Infrared Cut Removable or IR Cut Filter; adjust the IR LED working mode according to the ICR), and **CLOSE** (disable IR LED).
6. Set the IR LED switch delay. The **SWITCH DELAY(S)** refers to the delay time between switching between the far-distance IR LED and the N/M-distance IR LED.
7. Set the Smart IR. The brightness of the IR automatically changes according to the focal length. The greater the value, the more obvious the brightness changes.

Configuring PTZ Control Parameters

Purpose:

You can configure panning, tilting, and zooming movements, and configure PTZ control functions including presets, patrols, patterns, etc. for the speed dome.

Configuring PTZ Parameters

1. Enter the PTZ configuration menu: **MAIN MENU > DOME SETTINGS > MOTION PARAMETER.**

MOTION		MOTION	
AUTO FLIP	ON	PRESET SPEED	4
PROPORTIONAL PAN	ON	LIMIT STOP	OFF
PARK TIME	5	SETTING STOPS	
PARK ACT	NONE	CLEAR STOPS	
SCAN SPEED	28	ELEVATION SET	ON
IMAGE FREEZE	OFF		
DOME SPEED	6		
BACK	EXIT	BACK	EXIT

Figure 12, PTZ Configuration

- **Auto-Flip:** In manual tracking mode, when a target object goes directly beneath the speed dome, the speed dome automatically rotates 180 degrees horizontally for tracking.

NOTE: **AUTO-FLIP** is set to **ON** for this speed dome by default and is not user-definable.

- **Proportional Pan:** When the speed dome is zooming in/out, you can enable the proportional pan function to automatically reduce or increase the panning and tilting speed according to the zoom amount. This function enables the speed dome to trace the object at a proper speed when the speed dome is zooming and the monitored scene is narrowed (zoom in) or enlarged (zoom out).

You can set **PROPORTIONAL PAN** to **ON** or **OFF** to enable/disable the function.

NOTE: This function is enabled automatically when setting the patterns.

Park Time and Actions

Purpose:

This feature allows the speed dome to start a predefined action (park action: scan, preset, pattern, etc.) automatically after a period of inactivity (park time).

You can set **PARK TIME** from 5 to 720 seconds and set the park action (**PARK ACT**) as preset 1 to 8, pattern 1 to 5, patrol 1 to 10, pan scan, tilt scan, panoramic scan, day mode, night mode, or none.

NOTE: If no control signal is received after the park time under the following circumstances, no park actions will be performed: in the process of performing dome actions by calling special presets, or in the process of performing external alarm linkage actions.

- **Image Freeze:** This feature enables live view to switch directly from the current scene to another scene that is defined by a preset, without showing the middle areas between these two scenes. It reduces the use of bandwidth in a digital network system and also provides privacy protection for the middle areas. You can set **IMAGE FREEZE** to **ON** or **OFF** to enable or disable this function.

NOTE: The function varies by camera model.

PTZ Speed

Purpose:

You can define the speed of the dome movements.

- **DOME SPEED:** The manual movement speed of the dome can be set from level 1 to 10.
- **SCAN SPEED:** The scan speed defines the scan degree per second of pan scan, tilt scan, and panoramic scan. The scan speed is adjustable from level 1 to level 40 and the higher the level, the faster the scan speed.
- **PRESET SPEED:** The speed of calling a preset can be set from level 1 to 8. A higher level corresponds to a faster speed to call a preset.

Setting Limits

Purpose:

The limits are user-configurable positions that limit the panning and tilting area of the speed dome. There are left, right, up, and down limits to define an area.

1. Move the cursor to **ENABLE LIMIT** and click **FOCUS+** to set it **ON** to enable this feature. Click **IRIS+** to confirm the new settings.
2. Move the cursor to **SETTING STOPS** and click **IRIS+**. You will see the message *SET LEFT LIMIT* on the screen.
3. Click the direction buttons in the PTZ panel to configure the left limit. Click **IRIS+** to confirm the new settings.
4. Follow the prompts to configure the right, up, and down limits on the menu.

NOTE: The new limit will overwrite existing ones by default.

5. You can clear the defined limits. Click **IRIS+** to enter **CLEAR LIMITS** and click **IRIS+** again to clear the stops.

Elevation Set

You can set the **SET ELEVATION** as **ON** to increase the elevation angle range of the speed dome or set it as **OFF** to disable the function.

NOTE: The range of the elevation angle varies by speed dome model.

Configuring Presets

Purpose:

A preset is a user-defined monitoring position/point. Simply call the preset number to change the monitor scene to the defined position.

1. Move the cursor to enter the preset configuration submenu: **MAIN MENU > DOME SETTINGS > PRESETS**
2. Choose the preset number:
 - A. Move the cursor to **PRESET NUM.**

- B. Click **IRIS+** to enter.
- C. Click the up and down buttons to choose the preset number to edit. If the preset has been defined, the preset label will be listed under the number; if it has not been defined, you will see the information **UNDEFINED** under the number.

NOTE:

- Up to 256 presets can be set for the speed dome.
- The system-defined presets will be displayed on this submenu and they are not editable.

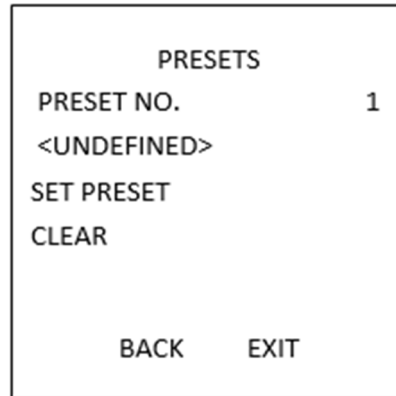

Figure 13, Preset Configuration Menu

3. Set the preset position.
 - A. Move the cursor to **PRESET PTZ** and click **IRIS+** to edit the preset position.
 - B. Use the direction buttons to move the speed dome to find the desired scene/position.
 - C. Ppress **IRIS+** to confirm the settings and return to the previous menu, or press **IRIS-** to cancel.

NOTE: The preset position settings will be restricted by the limits if they are defined.
4. Call up the preset. You can select the preset number from the drop-down preset list in the control panel of the encoder through a Web browser and click the arrow to call a user-defined or system-defined preset.
5. Clear the preset settings. Move cursor to **CLEAR** and click **IRIS+** to clear the current preset settings.

Configuring Patrols

Purpose:

A patrol is a scanning track specified by a group of user-defined presets. You can call a patrol to scan the scenes automatically among the user-defined presets in sequence.

1. Move the cursor to enter the patrol configuration submenu: **MAIN MENU > DOME SETTINGS > PATROLS.**

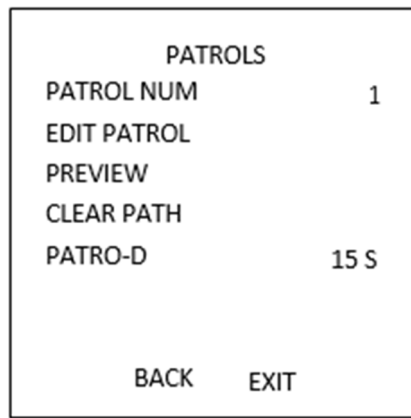

Figure 14, Patrol Configuration Menu

2. Choose the patrol number.
 - A. Move the cursor to **PATROL NUM** and click **IRIS+** to enter editing mode.
 - B. Click the up and down direction buttons to select the patrol number to be configured.
 - C. Click **IRIS+** again to confirm the settings and exit editing mode of this column.

NOTE: Up to 10 patrols can be configured.

3. Edit the patrol.
 - A. Move the cursor to **EDIT PATROL**, and click **IRIS+** to enter editing mode.

NUM	PST	DWELL	SPD
1	0	6	30
2	0	6	30
3	0	6	30
4	0	6	30
5	0	6	30
6	0	6	30
7	0	6	30
DONE: OPEN		QUIT: CLOSE	

Figure 15, Edit the Patrol

- B. Click up/down direction buttons to choose the number and locate the preset to be edited.
- C. Click left/right direction buttons to position the cursor to the column of **PRESET**, **DWELL**, and **SPEED**. You can click the up/down direction buttons to set the value of preset number, dwell time, and patrol speed.

NOTE: The presets you set for a patrol should be the ones that have been pre-defined by users. The dwell time (15 to 800 seconds is selectable, which are divided into 30 levels) is the time

that the speed dome stays at a certain preset; the patrol speed (level 1 to 40 is selectable) is the scanning speed the speed dome switches between the presets.

- D. Follow the above steps to define the other presets for the selected patrol. You can configure up to 32 presets in sequence for a patrol. Press **IRIS+** to save the new settings or press **IRIS-** to cancel and return to the previous menu.
4. Preview the patrol. Move the cursor to **PREVIEW** and click **IRIS+** to preview the current patrol. Click **IRIS+** again to stop the preview.
5. Call the defined patrol. You can call the special presets to call the defined patrol. E.g. call preset 35 to call patrol 1. Please refer to *Section 2.3* to find the corresponding preset number for each patrol.
6. Delete a patrol. You can move the cursor to **CLEAR PATH** and click **IRIS+** to delete the current patrol.
7. Define the dwell time when running the fast patrol. If you call the No.46 preset to enable the fast patrol, the speed dome will run the patrol automatically according to the route consists of the configured preset 1 to preset 32. And you can set the Patrol-D time switches from one preset to the other. 5 s, 10 s, 20 s, 30 s, and 60 s are selectable.

Configuring Patterns

Purpose:

A pattern is a memorized, repeatable series of pan, tilt, zoom, and preset movements that can be recalled by a command or automatically by a configured function (alarm, park, time task, and power-up).

1. Move the cursor to enter the **PATTERNS** submenu: **MAIN MENU > DOME SETTINGS > PATTERNS**.

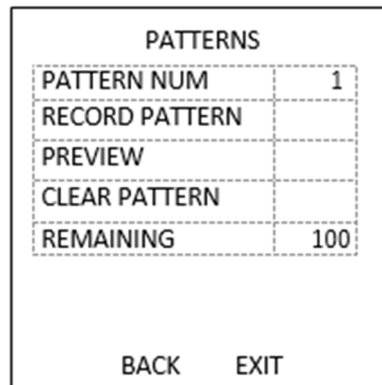

Figure 16, Pattern Configuration Menu

2. Choose the pattern number.
 - A. Move the cursor to **PATTERN NUM** and click **IRIS+** to enter the editing mode.
 - B. Click the up/down direction buttons to select the number of the pattern to be configured.
 - C. Click **IRIS+** again to confirm the settings.

NOTE: Up to five patterns can be configured.

3. Edit the pattern.

- A. Move the cursor to **RECORD PATTERN** and click **IRIS+** to enter editing mode.

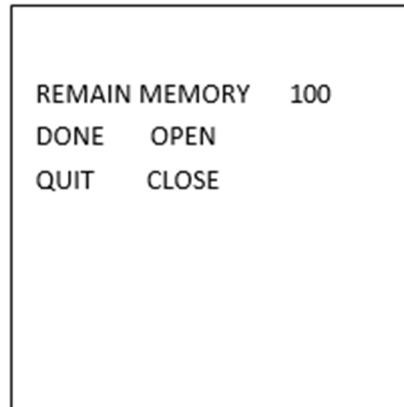

Figure 17, Edit the Pattern

- B. Click the PTZ control buttons and direction buttons to operate the speed dome to draw a movement path, including pan scan, tilt scan, zoom in, zoom out, etc. The speed dome can automatically memorize the path you operated as a pattern.

- C. Click **IRIS+** again to save the pattern and exit editing mode.

- **REMAIN MEMORY** indicates the remaining memory of the speed dome for configuring the patterns. When it reaches 0, no more patterns can be configured. You can also see the remaining memory shown under **PATTERNS** menu as *REMAINING*.
- The pan/tilt movements and the lens operations cannot be memorized simultaneously.

4. Preview the pattern. Enter the **PREVIEW** menu to preview the current pattern.

5. Call the defined pattern. You can call the special presets to call the defined pattern. E.g. call preset 41 to call pattern 1. Please refer to *Section 2.2* to find the corresponding preset number for each pattern.

6. Delete the patterns.

- A. To Delete a Chosen Pattern: Click **IRIS+** to enter **RECORD PATTERN** and you can see *DEL PATH ABOVE*. Click **IRIS+** to delete the pattern.

NOTE: If you delete the current pattern, the following pattern will also be deleted. E.g., if pattern 2 is deleted, pattern 3 and pattern 4 will be deleted as well.

- B. To Clear All the Patterns: Enter **CLEAR** menu and click **IRIS+** to delete all the defined patterns.

Configuring Timing Tasks

Purpose:

A timing task is a preconfigured action that can be performed automatically at a specific date and time.

1. Move the cursor to enter the **TIMING TASK** submenu: **MAIN MENU > DOME SETTINGS > TIMING TASK**.

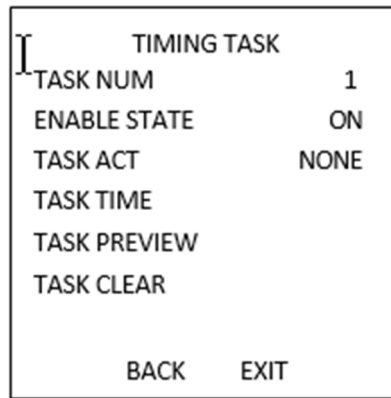

Figure 18, Time Task Configuration Menu

2. Choose the task number.
 - A. Move the cursor to **TASK NUM** and click **IRIS+** to enter the editing mode.
 - B. Click the up/down direction buttons to select the number of the task which is to be configured.
 - C. Click **IRIS+** again to confirm the settings and exit the editing mode.

NOTE: Up to eight time tasks can be configured.
3. Set the task status.
 - A. Move the cursor to **ENABLE TASK** and click **IRIS+** to enter the editing mode.
 - B. Click the up/down direction buttons to set the task status as **ON**.
 - C. Click **IRIS+** again to confirm the settings and exit the editing mode of this column.

NOTE: If the task action and task time have not been configured, you cannot set the status to **ON**.
4. Configure the task action.
 - A. Move the cursor to **TASK ACT** and click the **IRIS+** to enter editing mode.
 - B. Click the up and down direction buttons to select the task action from preset 1 to 8, pattern 1 to 5, patrol 1 to 10, pan scan, tilt scan, panoramic scan, day mode, night mode, zero calibrate, and none.
 - C. Click **IRIS+** again to confirm the settings and exit editing mode of this column.

5. Set the task time.
 - A. Move the cursor to **TASK TIME** and click **IRIS+** to enter editing mode.
 - B. Click the left and right direction buttons to position the cursor to **WEEK**, **START (H-M)**, and **END (H-M)**.
 - C. Click the up and down direction buttons to set the start time and end time to run the time task.
 - D. Click **IRIS+** to confirm the settings and exit.

NOTE: The weekday can be set from **Monday** to **Sunday** or **Whole Week**; the **H** refers to Hour and the **M** refers to Minute.

WEEK	WHOLE WEEK
START (H-M)	00 00
END (H-M)	00 00
DONE: OPEN	
QUIT: CLOSE	

Figure 19, Set the Task Time

6. Delete the task. Move the cursor to **TASK CLEAR**, click **IRIS+** to delete the time and action of the current task, and click **IRIS+** again to confirm the settings and exit.

Configuring Zone

Purpose:

A zone is a panning and tilting area defined by the left/right limits. You can configure the zones on **ZONES** submenu. You can define a zone when the targeted surveillance scene is limited.

1. Move the cursor to enter the zone configuration submenu: **MAIN MENU > DOME SETTINGS > ZONES**.

ZONES		
ZONE NUM		1
<UNDEFINED>		
EDIT ZONE		
ZONE STATUS		ON
SCAN STATUS		ON
CLEAR ZONE		
BACK	EXIT	

Figure 20, Zone Configuration

2. Choose the zone number:
 - A. Move the cursor to **ZONE NUM.** and click **IRIS+** button to enter the editing mode.
 - B. Click the up and down buttons to select the zone number to be configured.
 - C. Click **IRIS+** again to confirm the settings and exit the editing mode of this column.

NOTE: Up to eight zones can be configured.

3. Configure the zone area.
 - A. Move the cursor to **EDIT ZONE** and click **IRIS+** button to enter the editing mode.
 - B. You can see *SET LEFT LIMIT* on the screen. Click the direction buttons to set the left limit.
 - C. Follow the prompts on the screen to set the right limit.
 - D. Click **IRIS+** button to save the settings and exit.

4. Set the zone status and scan status.

- **ZONE STATUS:** The zone status just indicates the current status of the zone.
- **SCAN STATUS:** You can set the scan status to **ON/OFF** to enable/disable the scanning in the zone.

NOTE: **ZONE STATUS** is not editable. After you edit the zone, it will switch to **ON** automatically; if you delete the zone, the **ZONE STATUS** will switch to **OFF**.

5. Clear the zone settings. Move the cursor to **CLEAR ZONE**, click **IRIS+** to clear all the settings of the current zone, and click **IRIS+** again to confirm the settings and exit.

Configuring Smart Settings

Purpose:

Set the smart settings to **ON** to automatically track the moving object, and meanwhile adjusts the focus and the position to set the target in the center of the field of view.

1. Move the cursor to enter the smart setting submenu: **MAIN MENU > DOME SETTINGS > SMART SETTINGS.**

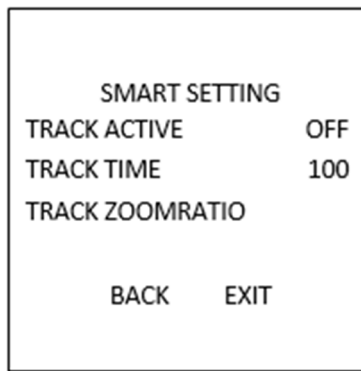

Figure 21, Smart Setting

2. Set the tracking time.
 - A. Move the cursor to **TRACK TIME** and click **IRIS+** button to enter the editing mode.
 - B. Click the up and down buttons to set the duration for tracking.
 - C. Click **IRIS+** again to confirm the settings and exit the editing mode of this column.
3. Set the track zoom ratio. Once the zoom ratio is set that the target will be displayed in that ratio on the monitor.
 - A. Move the cursor to **TRACK ZOOM RATIO** and click **IRIS+** button to enter the editing mode.
 - B. Click **IRIS+** again to confirm the settings and exit the editing mode of this column.
4. Turn on the tracking.
 - A. Move the cursor to **TRACK ACTIVE** and click **IRIS+** button to enter the editing mode.
 - B. Click the up and down buttons to set the **TRACK ACTIVE** as **ON**.
 - C. Click **IRIS+** again to confirm the settings and exit the editing mode of this column.

NOTE: The function varies by camera model.

Configuring Clear Settings

1. Move the cursor to enter the clear settings submenu: **MAIN MENU > DOME SETTINGS > CLEAR SETTINGS**.

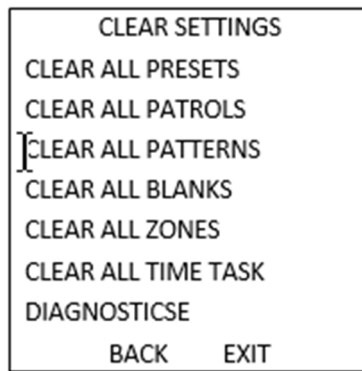

Figure 22, CLEAR SETTINGS

2. Move the cursor to the item you want to clear, and click **IRIS+** to validate the settings.
3. Move the cursor to **DIAGNOSTICS**, and click **IRIS+** to diagnose the temperature exception, video exception, voltage exception, etc.

NOTE: The function varies by camera model.

Configuring and Handling Alarms

NOTE: The alarm related function is not supported by the 7-inch IR speed dome.

Configuring Alarm Input and Linkage Actions

Purpose:

This section states how to configure the speed dome to respond to alarm events with alarm linked actions such as calling presets, patrols, patterns, scanning, etc.

1. Move the cursor to enter the alarm configuration submenu: **MAIN MENUS > DOME SETTINGS > ALARMS.**

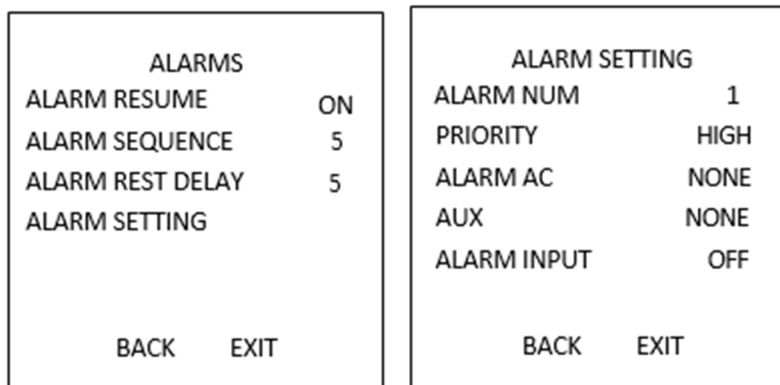

Figure 23, Alarm Configuration Menu

2. Choose the alarm number.
 - A. Move the cursor to **ALARM NUM** and click the **IRIS+** to enter the editing mode.

- B. Click the up and down direction buttons to select the alarm number to be configured.
- C. Click **IRIS+** again to confirm and exit editing mode of this column.

NOTE: You can configure up to two alarm inputs.

3. Move the cursor to **ALARM SETTING** and click the **IRIS+** to enter the setting alarm submenu.

4. Configure the alarm input.

- A. Move the cursor to **ALARM INPUT** and click the **IRIS+** to enter the editing mode.
- B. Click the up and down direction buttons to set the input status. You can configure it as **OPEN** (Normally open), **CLOSE** (Normally closed) or **OFF** (disable the alarm input).
- C. Click **IRIS+** again to confirm.

NOTE: If you set the status as **OPEN**, alarm will be triggered by high electricity level; if you set the status as **CLOSE**, alarm will be triggered by low electricity level; if you set the status as **OFF**, it will be triggered when this input channel is shut off.

5. Configure the alarm linkage action to specify the linked action when an alarm occurs.

- A. Move the cursor to **ALARM AC** and click the **IRIS+** to enter the editing mode.
- B. Click the up and down direction buttons to choose the desired linkage action. You can set the alarm action as preset from 1 to 8, pattern from 1 to 5, patrol from 1 to 10, panning scan, tilting scan, panoramic scan, day mode, night mode, or none. You can also set the alarm output for the alarm. Refer to *Section 3.5.3 Configuring Auxiliary Alarm* Output for details.

6. Configure alarm priority. Enter the **PRIORITY** menu and set the alarm priority as **HIGH**, **MIDUEM** or **LOW**. If multiple alarms with different priorities are triggered at the same time, the dome responds only to the alarm with the highest priority. If multiple alarms with the same priority are triggered at the same time, then the dome will respond to each alarm according to the defined alarm sequence.

Configuring Alarm Parameters

Purpose:

You can set the alarm related parameters, including linkage action interval, alarm duration, and dome activity resumption by following the instructions below

1. Enter the alarm parameter configuration menu: **MAIN MENUS > DOME SETTINGS > ALARMS**.
2. Configure the alarm sequence interval.

NOTE: When more than one alarm of the same priority occurs at the same time, the speed dome will respond to one alarm first and then respond to the next one after the user-defined interval. You can set this on the **SEQUENCE** submenu from 1 to 200 seconds.

3. Configure the alarm rest delay. If a linkage action has already been triggered by an alarm input, the

speed dome will respond only to input from the same channel again after the user-defined reset delay time. This is the rest time that the speed dome considers an alarm to be active when it's physically cleared. You can set the **DELAY TIME** from 0 to 300 seconds.

- Resume the dome activity. You can set **ALARM RESUME** as **ON** to enable the speed dome to resume its previous activity after the triggered actions finished.

NOTE:

- If the speed dome is moving when a linkage action is triggered, it will stop at the current position and resume from this position after the linkage action is finished.
- The speed dome can be configured to resume the PTZ positions, focus, and iris value.

Configuring Auxiliary Alarm Output

Purpose:

An auxiliary alarm output is a configurable alarm output interface on the speed dome back box, which can connect and trigger another alarm device to operate.

- Enter the alarm output configuration submenu: **MAIN MENU > DOME SETTINGS > AUXS**.

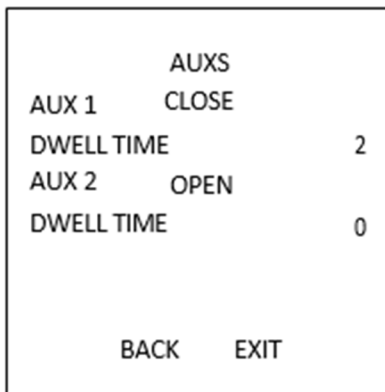

Figure 24, Configure the Alarm Output

- Click **IRIS+** to edit the status of the alarm outputs. You can set the auxiliary alarm output type as **OPEN** (normally open) and **CLOSE** (normally closed).
- Move the cursor to **DWELL TIME** to set the duration of the alarm output signal. The configurable range is 0 to 60 seconds.
- Link the alarm output to the configured alarm.
 - Enter **MAIN MENU > DOME SETTINGS > ALARMS > ALARM SETTING** and choose the alarm number that you want to link the alarm output to.
 - Move the cursor to **AUXS** and click **IRIS+** to configure the alarm output to the alarm. You can choose **OPEN** to activate AUX 1.

Other

Restoring Default Dome Settings

Purpose:

You can reset all dome settings to factory default parameters as shown below.

NOTE: Dome settings are mainly of PTZ and alarm parameters and also include some system settings, e.g., dome address.

1. Enter default dome settings menu: **MAIN MENU > RESTORE DEFAULTS**.
2. Click **IRIS+** to restore the dome settings to the default value, or click **IRIS-** to exit.

Restoring Default Camera Settings

1. Enter **MAIN MENU > RESTORE CAMERA**.
2. Click **IRIS+** to restore the camera settings to the default value, or click **IRIS-** to exit.

Rebooting the Dome

1. Enter **MAIN MENU > REBOOT DOME** and click **IRIS+** to reboot the speed dome.

4 Appendix

Appendix 1 Lightning and Surge Protection

This product adopts TVS plate lightning protection technology to avoid damage caused by a pulse signal that is below 3000 W, like instantaneous lighting stroke, surging, etc. According to the actual outdoor situation, necessary protection measures must be taken, besides ensuring electrical safety.

- The distance between signal transmission wires and high-voltage equipment or high-voltage cable should be at least 50 m.
- Outdoor wiring should be routed under eaves as much as possible.
- In open fields, wiring should be buried underground in sealed steel pipe, and the steel-pipe should be one-point grounding. Overhead routing method is forbidden.
- In strong thunderstorm or high induction voltage areas (such as high-voltage transformer substation), high power lightning protection apparatus and lightning conductor are necessary.
- Lightning protection and outdoor device grounding and cables should be considered together with the lightning protection demand of building designs. It also must conform to the related national standards and industrial standards.
- The system should be equipotential grounded. The grounding equipment must conform to the demands of both system anti-jamming and electrical safety and it must not appear short circuit or mixed circuit with the zero conductor of strong grid. When the system is grounded alone, the resistance should be no more than 4Ω . The sectional area of the grounding cable should be no less than 25 mm^2 . For grounding instructions, please refer to the Speed Dome Installation Manual.

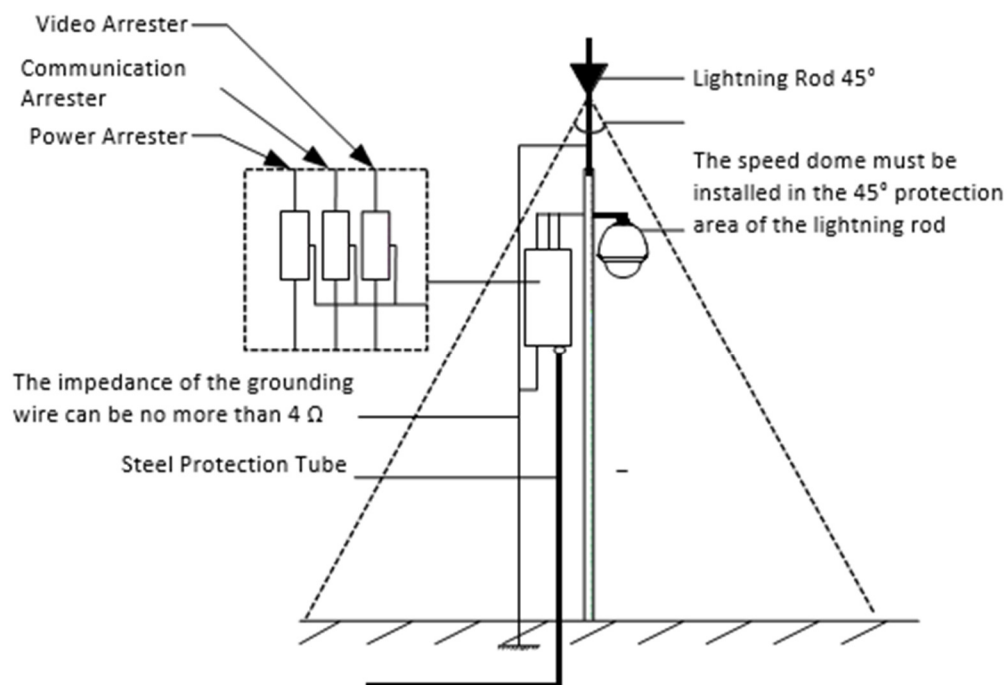

Figure 25, Lightning and Surge Protection

Appendix 2 RS-485 Bus Connection

- General Property of RS-485 Bus

According to RS-485 industry bus standard, RS-485 is a half-duplex communication bus that has 120 Ω characteristic impedance. The maximum load ability is 32 payloads (including controller device and controlled device).

- RS-485 Bus Transmission Distance

When using 0.56 mm (24 AWG) twisted-pair line, according to different baud rate, the maximum transmission distance theory table is shown as below:

Table A-1 Maximum Distance of RS-485 Transmission

Baud Rate	Maximum Distance
2400 bps	1800 m
4800 bps	1200 m
9600 bps	800 m

The transmission distance will be decreased if we use thinner cable, use this product under a strong electromagnetic interference situation, or lots of devices are added to the bus; on the contrary, the transmission distance will be increased.

- Connection Methods

RS-485 industry bus standard requires a daisy-chain connection method between devices, both sides have to connect a 120 Ω terminal resistance (shown as Diagram 1). A simplified connection method is shown in Diagram 2, but the distance of "D" should not be too long.

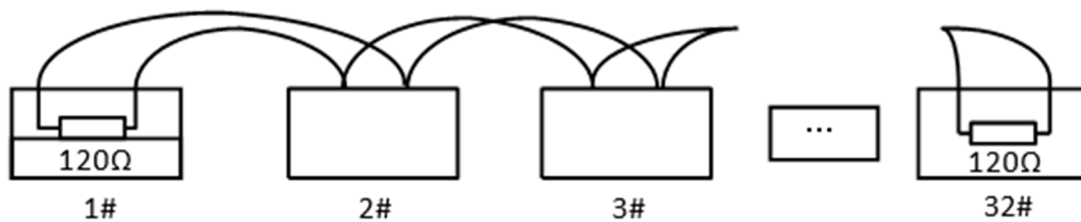

Figure 26, RS-485 Connection 1

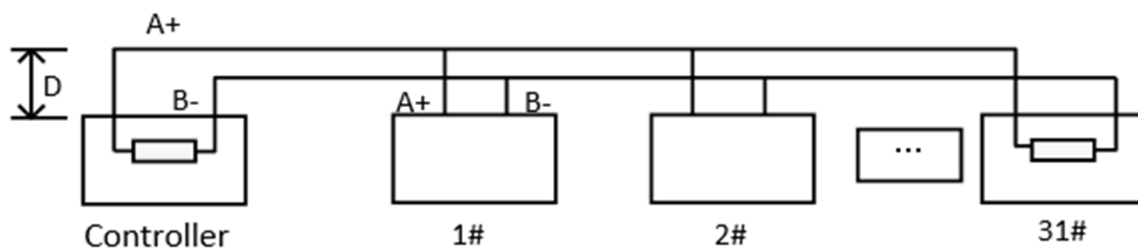

Figure 27, RS-485 Connection 2

- Problems in the Practical Application

Normally, users adopt a star-shape connection method in construction. Under this situation, the terminal resistors must be connected between the two farthest devices (as Figure 4, 1# and 15#), but this connection method does not satisfy the requirement of the RS-485 industry standard, because it can lead to problems such as signal reflection and anti-jamming ability decline when the devices are distant. At this time, the dome will be uncontrollable, or self-running, etc.

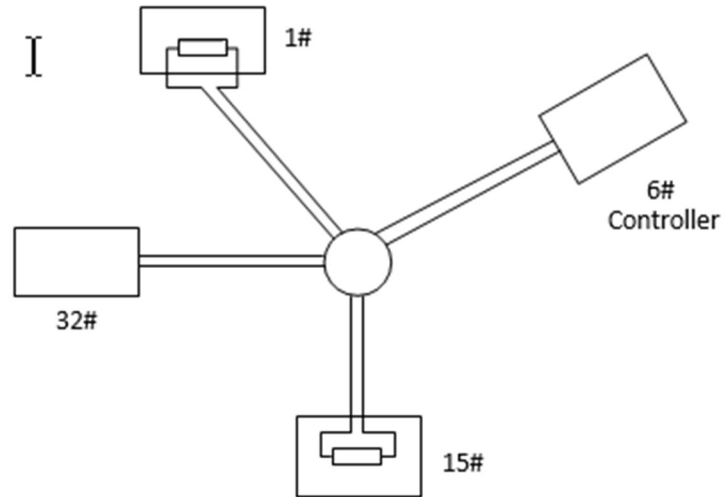

Figure 28, Star Shape Connection

For such cases, the best way to add a RS-485 distributor. This product can effectively change the star-shape connection to one that satisfies the RS-485 industry standard requirement, in order to avoid these problems and improve communication reliability. See Figure 5.

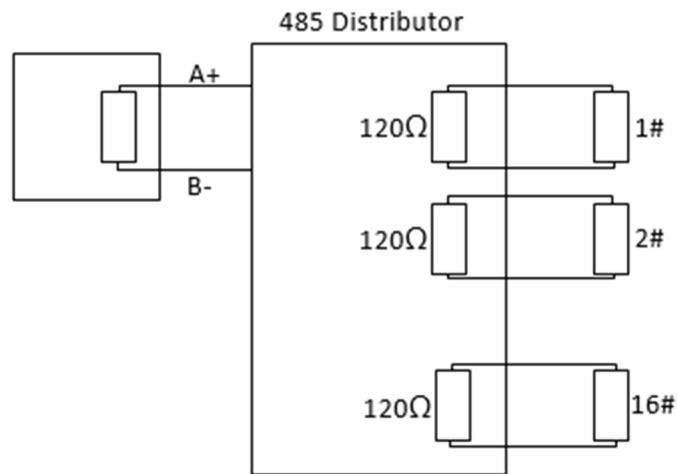

Figure 29, RS-485 Distributor

- Troubleshooting RS-485 Communication

Problem	Possible Reasons	To Solve the Problem
The speed dome does the self-test action, but cannot be controlled remotely	1. The speed dome address or baud rate does not match those of the remote control device	1. Adjust the remote control device address and baud rate to match those of the speed dome
	2. The RS-485+ connects to the interface RS-485- and RS-485- connects to the interface RS-485+	2. Connect the RS-485+ to the interface RS-485+ and RS-485- to the interface RS-485-
	3. The RS-485 wire is disconnected	3. Reconnect the RS-485 wire tightly
	4. RS-485 wire is broken	4. Change a RS-485 wire
The speed dome can be controlled, but not smoothly	1. The connection is loose	1. Reconnect the RS-485 wire tightly
	2. RS485+ or RS485-wire is broken	2. Change an RS-485 wire
	3. The speed dome is too far from the remote control device	3. Add a terminal resistor
	4. Too many speed domes are connected	4. Add an RS-485 distributor

Appendix 3 24 VAC Wire Gauge and Transmission Distance

The following table describes the recommended maximum distance adopted for a specific wire gauge when the 24 VAC voltage loss rate is less than 10 percent. For an AC-driven device, the maximum allowed voltage loss rate is 10 percent. For example, for a device with a rating power of 80 VA, which is installed at a distance of 35 feet (10 m) away from the transformer, 0.8000 mm is required as the minimum wire gauge.

Distance (feet) \ Wire Gauge (mm) \ Power (VA)	0.8000	1.000	1.250	2.000
10	283(86)	451(137)	716(218)	1811(551)
20	141(42)	225(68)	358(109)	905(275)
30	94(28)	150(45)	238(72)	603(183)
40	70(21)	112(34)	179(54)	452(137)
50	56(17)	90(27)	143(43)	362(110)
60	47(14)	75(22)	119(36)	301(91)
70	40(12)	64(19)	102(31)	258(78)
80	35(10)	56(17)	89(27)	226(68)
90	31(9)	50(15)	79(24)	201(61)
100	28(8)	45(13)	71(21)	181(55)
110	25(7)	41(12)	65(19)	164(49)
120	23(7)	37(11)	59(17)	150(45)
130	21(6)	34(10)	55(16)	139(42)
140	20(6)	32(9)	51(15)	129(39)
150	18(5)	30(9)	47(14)	120(36)
160	17(5)	28(8)	44(13)	113(34)
170	16(4)	26(7)	42(12)	106(32)
180	15(4)	25(7)	39(11)	100(30)
190	14(4)	23(7)	37(11)	95(28)
200	14(4)	22(6)	35(10)	90(27)

Appendix 4 Wire Gauge Standards

Bare Wire Gauge (mm)	America Wire Gauge AWG	British Wire Gauge SWG	Cross-Sectional Area of Bare Wire (mm ²)
0.750	21		0.4417
0.800	20	21	0.5027
0.900	19	20	0.6362
1.000	18	19	0.7854
1.250	16	18	1.2266
1.500	15	17	1.7663
2.000	12	14	3.1420
2.500			4.9080
3.000			7.0683

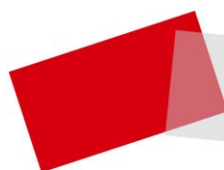

First Choice for Security Professionals