

DS-2DF8442IXS-AELW (T2) 4 MP 42x Network IR Speed Dome

DarkFighter™



Hikvision's DS-2DF8442IXS-AELW (T2) 4 MP 42x Network IR Speed Dome is equipped with a 1/1.8" progressive scan CMOS chip. The camera's 42x optical zoom lens offers enhanced details over expansive areas. The DS-2DF8442IXS-AELW (T2) is especially well-suited to providing high-definition images of sprawling outdoor spaces such as wilderness areas, roadways, railways, airports, ports, squares, parks, scenic spots, stations, large venues, etc.

Available Model

DS-2DF8442IXS-AELW (T2)

- 1/1.8" Progressive Scan CMOS
- Up to 2560 × 1440 Resolution
- Minimum Illumination:
Color: 0.002 Lux @ (f/1.2, AGC On)
B/W: 0.0002 Lux @ (f/1.2, AGC On)
0 Lux with IR
- 42x Optical Zoom, 16x Digital Zoom
- 140 dB WDR, 3D DNR, HLC, Smart IR
- 24 VAC and Hi-PoE
- Up to 1,640 ft (500 m) IR Distance
- H.265+/H.265 Video Compression
- Rapid Focus
- IK10 (Except Lens), IP67
- Vandal-Proof Alarm



Specifications

DS-2DF8442IXS-AELW (T2)	
Camera Module	
Image Sensor	1/1.8" progressive scan CMOS
Minimum Illumination	Color: 0.002 lux @ (f/1.2, AGC on) B/W: 0.0002 lux @ (f/1.2, AGC on), 0 lux with IR
Shutter Speed	1/1s to 1/30,000s
Slow Shutter	Yes
Focus	Semi-auto, manual, auto
Day/Night	ICR
Day/Night Switch	Day, night, auto, scheduled-switch
BLC	Yes
WDR	140 dB WDR
HLC	Yes
3D DNR	Yes
EIS	Yes. Built-in gyroscope to improve EIS performance.
Regional Exposure	Yes
Regional Focus	Yes
White Balance	Auto
Digital Zoom	16x
Optical Zoom	42x
Privacy Mask	Up to 24 masks, polygon region, mosaic mask, mask color configurable
General Function	Mirror, password protection, watermark, IP address filter
Optical Defog	Yes
Lens	
Focal Length	6.0 mm to 252 mm, 42x optical
Zoom Speed	Approximately 4.5 s
FOV	Horizontal field of view: 56.6° to 1.7° (wide-tele), vertical field of view: 33.7° to 0.9° (wide-tele), diagonal field of view: 63.4° to 1.9° (wide-tele)
Aperture	f/1.2
PTZ	
Movement Range (Pan)	360°
Movement Range (Tilt)	-20° to 90° (auto flip)
Pan Speed	Pan speed: configurable from 0.1° to 210°/s; preset speed: 280°/s
Tilt Speed	Tilt speed: configurable from 0.1° to 150°/s; preset speed: 250°/s
Proportional Zoom	Yes
Presets	300
Patrol Scan	8 patrols, up to 32 presets for each patrol
Pattern Scan	4 pattern scans, record time over 10 minutes for each scan
Power-Off Memory	Yes
Park Action	Preset, pattern scan, patrol scan, auto scan, tilt scan, random scan, frame scan, panorama scan
3D Positioning	Yes
PTZ Status Display	Yes
Preset Freezing	Yes
Scheduled Task	Preset, pattern scan, patrol scan, auto scan, tilt scan, random scan, frame scan, panorama scan, dome reboot, dome adjust, aux output
Video	
Maximum Resolution	2560 × 1440
Main Stream	60 Hz: 30 fps (2560 × 1440, 1920 × 1080, 1280 × 960, 1280 × 720) 60 fps (2560 × 1440, 1920 × 1080, 1280 × 960, 1280 × 720)
Sub-Stream	60 Hz: 30 fps (704 × 480, 640 × 480, 352 × 240)
Third Stream	60 Hz: 30 fps (1920 × 1080, 1280 × 960, 1280 × 720, 704 × 480, 640 × 480, 352 × 240)
Video Compression	H.265, H.264, MJPEG
H.264 Type	Baseline profile, main profile, high profile
H.265 Type	Main profile
H.264+	Yes
H.265+	Yes
Video Bit Rate	32 Kbps to 16384 Kbps
SVC	Yes
ROI	Dynamic face tracking, fixed region, dynamic license plate tracking
Audio	
Audio Compression	G.711 alaw, G.711 ulaw, G.722.1, G.726, MP2L2, PCM
Audio Bit rate	64 Kbps (G.711)/16 Kbps (G.722.1)/16 Kbps (G.726)/32 Kbps to 192 Kbps (MP2L2)



Specifications (continued)

DS-2DF8442IXS-AELW (T2)	
Smart Features	
Face Capture	Detect up to 30 faces at the same time, detect, track, capture, grade, select face in motion, and output the best face picture
Road Traffic Basic Event	Vehicle detection (license plate number, vehicle model, and vehicle color recognition)
Smart Event	Motion detection, video tampering alarm, alarm input and output
Smart Tracking	Unattended baggage detection, object removal detection, intrusion detection, line crossing detection, region entrance detection, region exiting detection, audio exception detection, vandal-proof alarm
Smart Record	Manual tracking, event tracking, auto-tracking
Alarm Linkage	ANR, Dual-VCA
Network	
Protocols	Alarm actions such as Preset, Patrol Scan, Pattern Scan, Memory Card Video Record, Trigger Recording, Notify Surveillance Center, Upload to FTP/Memory Card/NAS, Send E-mail, etc.
API	IPv4/IPv6, HTTP, HTTPS, 802.1x, QoS, FTP, SMTP, UPnP, SNMP, DNS, DDNS, NTP, RTSP, RTCP, RTP, TCP/IP, DHCP, PPPoE, UDP, IGMP, ICMP, Bonjour
Simultaneous Live View	ISAPI, Hikvision SDK, ONVIF (Profile S, Profile G, Profile T)
User/Host	Up to 20 channels
Smooth Streaming	Up to 32 users. 3 levels: administrator, operator, and user
Security Measures	Yes
Client	User authentication (ID and PW), host authentication (MAC address); HTTPS encryption; IEEE 802.1x port-based network access control; IP address filtering
Web Browser	iVMS-4200, iVMS-4500, Hik-Connect
Interface	
Communication Interface	1 RJ-45 10 M/100 M Ethernet Interface; Hi-PoE
On-Board Storage	Built-in memory card slot, supports microSD/SDHC/SDXC up to 256 GB; NAS (NFS, SMB/CIFS), ANR
Alarm Input	7 alarm inputs
Alarm Output	2 alarm outputs
Audio Input	1 audio input, 2.0 to 2.4 V p-p, 1k ohm \pm 10%
Audio Output	1 audio output, line level, impedance: 600 Ω
Video Output	1.0V [p-p]/75 Ω , PAL, NTSC, BNC connector
RS-485	HIKVISION, Pelco-P, Pelco-D, self-adaptive
Supplement Light	
IR Distance	1,640 ft (500 m)
Smart IR	Yes
General	
Power	24 VAC (maximum 60 W, including maximum 18 W for IR and maximum 6 W for heater), Hi-PoE (maximum 50 W, including maximum 18 W for IR and maximum 6 W for heater)
Operating Conditions	Temperature: -40° to 70° C (-40° to 158° F), humidity: \leq 95% non-condensing
Wiper	Yes
Dimensions	\varnothing 266.6 mm \times 410 mm (\varnothing 10.50" \times 16.14")
Weight	Approximately 8 kg (17.64 lb)
Web Client Language	32 languages: English, Russian, Estonian, Bulgarian, Hungarian, Greek, German, Italian, Czech, Slovak, French, Polish, Dutch, Portuguese, Spanish, Romanian, Danish, Swedish, Norwegian, Finnish, Croatian, Slovenian, Serbian, Turkish, Korean, Traditional Chinese, Thai, Vietnamese, Japanese, Latvian, Lithuanian, Portuguese (Brazil)
Approvals	
Protection	Lightning protection, surge protection and voltage transient protection, \pm 6 kV line to gnd, \pm 3 kV line to line, IEC61000-4-5, IP67 standard, IK10

DORI

The DORI (detect, observe, recognize, identify) distance gives a general idea of the camera's ability to distinguish persons or objects within its field of view.







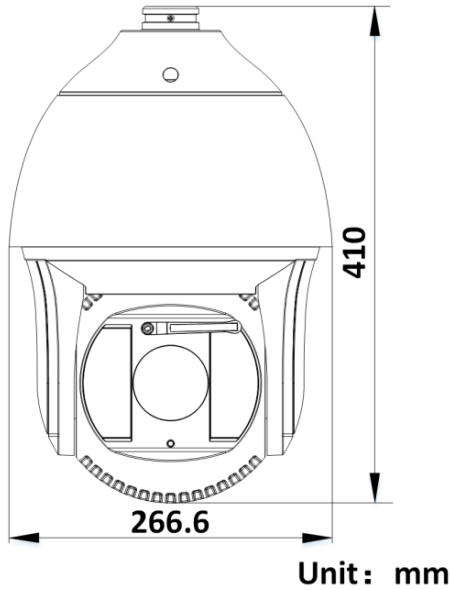

It is calculated based on the camera sensor specification and the criteria given by EN 62676-4: 2015.

DORI	Detect	Observe	Recognize	Identify
Definition	25 px/m	63 px/m	125 px/m	250 px/m
Distance (Tele)	2979.3 m (9774.6 ft)	1182.3 m (3878.9 ft)	595.9 m (1955.1 ft)	297.9 m (977.4 ft)

Dimensions



Accessories

INCLUDED	NOT INCLUDED			
 (actual product appearance may vary) G1.5 Adapter Converts Hikvision Quick Release to G 1.5" Thread	 CMP-JB Corner Mounting Bracket	 CPM-S Pendant Mounting Bracket Short	 JBPW-L Wall Mounting Bracket	 PMP-JB Pole Mounting Bracket
 (actual product appearance may vary) 60 Watt PoE Injector With Power Cable	 RPM Roof Parapet Mount	 WMP-L Wall Mount Bracket	 CPM-L Pendant Mounting Bracket Long	