

PCI-D18F2S(B)

8 MP AcuSense Fixed Dome Network Camera



Powered by
DarkFighter™

Empowered by deep learning algorithms, Hikvision AcuSense technology brings human and vehicle targets classification alarms to front- and back-end devices. The system focuses on human and vehicle targets, vastly improving alarm efficiency and effectiveness.

Available Models

PCI-D18F2S: Hikvision white

PCI-D18F2SB: Black

- High Quality Imaging with 8 MP Resolution
- Excellent Low-Light Performance with Powered-by-DarkFighter Technology
- Efficient H.265+ Compression Technology
- Clear Imaging Against Strong Backlight Due to 120 dB True WDR Technology
- Focus on Human and Vehicle Target Classification Based on Deep Learning
- Advanced Streaming Technology that Enables Smooth Live View and Data Self-Correcting in Poor Network
- Water and Dust Resistant (IP67) and Vandal-Resistant (IK10)



Specifications

PCI-D18F2S(B)	
Camera	
Image Sensor	1/1.8" progressive scan CMOS
Minimum Illumination	Color: 0.003 lux @ (f/1.6, AGC on), B/W: 0 lux with IR
Shutter Speed	1/3 s to 1/100,000 s
Slow Shutter	Yes
P/N	P/N
Wide Dynamic Range	120 dB
Day/Night	IR cut filter
Angle Adjustment	Pan: 0° to 355°, tilt: 0° to 75°, rotate: 0° to 355°
Lens	
Lens Type	Fixed focal lens
Iris Type	Fixed
Lens Mount	M12
Focal Length and FOV	2.8 mm, horizontal FOV 110°, vertical FOV 57°, diagonal FOV 134°
Aperture	f/1.6
DORI	
DORI	2.8 mm: D: 89 m, O: 35 m, R: 18 m, I: 9 m
Illuminator	
IR Range	Up to 131 ft (40 m)
IR Wavelength	850 nm
Smart Supplement Light	Yes
Video	
Maximum Resolution	3840 × 2160
Main Stream	50 Hz: 25 fps (3840 × 2160, 3200 × 1800, 2688 × 1520, 1920 × 1080, 1280 × 720) 60 Hz: 24 fps (3840 × 2160), 30 fps (3200 × 1800, 2688 × 1520, 1920 × 1080, 1280 × 720)
Sub-Stream	50 Hz: 25 fps (640 × 480, 640 × 360) 60 Hz: 30 fps (640 × 480, 640 × 360)
Third Stream	50 Hz: 10 fps (1920 × 1080, 1280 × 720, 640 × 480, 640 × 360) 60 Hz: 10 fps (1920 × 1080, 1280 × 720, 640 × 480, 640 × 360) *Third stream is supported under certain settings
Fourth Stream	50 Hz: 10 fps (1280 × 720, 640 × 480, 640 × 360) 60 Hz: 10 fps (1280 × 720, 640 × 480, 640 × 360) *Fourth stream is supported under certain settings
Video Compression	Main stream: H.265/H.264/H.265+/H.264+ Sub-stream: H.265/H.264/MJPEG Third stream: H.265/H.264 Fourth stream: H.265/H.264/MJPEG *Third stream and fourth stream are supported under certain settings
Video Bit Rate	32 Kbps to 16 Mbps
H.264 Type	Baseline profile/main profile/high profile
H.265 Type	Main profile
H.264+	Main stream supports
H.265+	Main stream supports
Bit Rate Control	CBR/VBR
Scalable Video Coding (SVC)	H.265 and H.264 encoding
Region of Interest (ROI)	5 fixed regions for main stream and sub-stream
Audio	
Environment Noise Filtering	Yes
Audio Sampling Rate	8 kHz/16 kHz/32 kHz/44.1 kHz/48 kHz
Audio Compression	G.711ulaw/G.711alaw/G.722.1/G.726/MP2L2/PCM/MP3/AAC
Audio Bit Rate	64 Kbps (G.711ulaw/G.711alaw)/16 Kbps (G.722.1)/16 Kbps (G.726)/32 to 192 Kbps (MP2L2)/8 to 320 Kbps (MP3)/16 to 64 Kbps (AAC)
Network	
Simultaneous Live Views	Up to 6 channels
API	Open Network Video Interface (PROFILE S, PROFILE G, PROFILE T), ISAPI, SDK, ISUP5.0
Protocols	TCP/IP, ICMP, HTTP, HTTPS, FTP, DHCP, DNS, DDNS, RTP, RTSP, NTP, UPnP, SMTP, IGMP, 802.1x, QoS, IPv4, IPv6, UDP, Bonjour, SSL/TLS, PPPoE, ARP, SNMP
User/Host	Up to 32 users. 3 user levels: administrator, operator, and user

Specifications (continued)

PCI-D18F2S(B)	
Network (continued)	
Security	Password protection, complicated password, HTTPS encryption, IP address filter, Security Audit Log, basic and digest authentication for HTTP/HTTPS, TLS 1.1/1.2, WSSE and digest authentication for Open Network Video Interface
Network Storage	NAS (NFS, SMB/CIFS), auto network replenishment (ANR); together with high-end Hikvision memory card, memory card encryption and health detection are supported
Client	iVMS-4200, Hik-Connect, HikCentral
Web Browser	Plug-in required live view: IE 10+ Plug-in free live view: Chrome 57.0+, Firefox 52.0+ Local service: Chrome 57.0+, Firefox 52.0+
Image	
SNR	≥52 dB
Day/Night Switch	Day, Night, Auto, Schedule
Target Cropping	Yes
Image Enhancement	BLC, HLC, 3D DNR
Image Parameters Switch	Yes
Image Settings	Rotate mode, saturation, brightness, contrast, sharpness, gain, white balance adjustable by client software or Web browser
Interface	
Alarm	1 input, 1 output (maximum 12 VDC, 30 mA)
Audio	1 input (line in), maximum input amplitude: 3.3 vpp, input impedance: 4.7K Ω, interface type: non-equilibrium 1 output (line out), maximum output amplitude: 2.5 vpp, output impedance: 100 Ω, interface type: non-equilibrium, mono sound
Built-in Microphone	Yes
On-Board Storage	Built-in memory card, supports microSD/SDHC/SDXC card, up to 256 GB
Hardware Reset	Yes
Ethernet Interface	1 RJ-45 10 M/100 M self-adaptive Ethernet port
Power Output	12 VDC, maximum 100 mA (supported by all power supply types)
Event	
Basic Event	Motion detection (human and vehicle targets classification), video tampering alarm, exception
Smart Event	Unattended baggage detection, object removal detection, scene change detection, audio exception detection
Deep Learning Function	
Face Capture	Yes
Perimeter Protection	Line crossing detection, intrusion detection, region entrance detection, region exiting detection *Supports human and vehicle targets classification
General	
Linkage Method	Upload to NAS/memory card/FTP, notify surveillance center, trigger recording, trigger capture, send email, audible warning, trigger alarm output
Firmware Version	V5.5.113
Web Client Language	33 languages: English, Russian, Estonian, Bulgarian, Hungarian, Greek, German, Italian, Czech, Slovak, French, Polish, Dutch, Portuguese, Spanish, Romanian, Danish, Swedish, Norwegian, Finnish, Croatian, Slovenian, Serbian, Turkish, Korean, Traditional Chinese, Thai, Vietnamese, Japanese, Latvian, Lithuanian, Portuguese (Brazil), Ukrainian
General Function	Anti-flicker, heartbeat, mirror, privacy mask, flash log, password reset via e-mail, pixel counter
Software Reset	Yes
Storage Conditions	-30° to 60° C (-22° to 140° F), humidity 95% or less (non-condensing)
Startup and Operating Conditions	-30° to 60° C (-22° to 140° F), humidity 95% or less (non-condensing)
Power Supply	12 VDC ±25%, reverse polarity protection PoE: 802.3af, Type 1, Class 3
Power Consumption and Current	12 VDC, 0.6 A, maximum 7 W PoE (802.3af, 36 V to 57 V), 0.25 A to 0.15 A, maximum 8.5 W
Power Interface	Ø5.5 mm coaxial power plug
Camera Material	Base: metal; cover: metal
Camera Dimensions	Ø121.4 mm × 92.2 mm (Ø4.8" × 3.6")
Package Dimensions	150 mm × 150 mm × 141 mm (5.9" × 5.9" × 5.6")
Camera Weight	Approximately 550 g (1.2 lb)
With Package Weight	Approximately 800 g (1.8 lb)







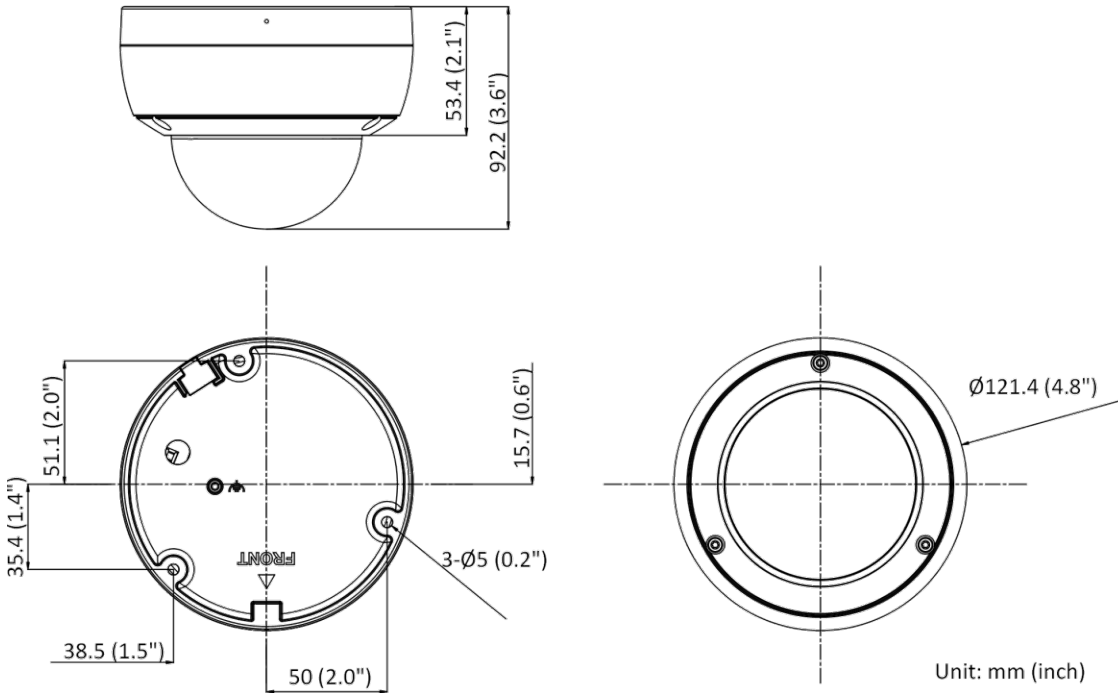

Specifications (continued)

PCI-D18F2S(B)	
Approvals	
EMC	FCC SDoC (47 CFR Part 15, Subpart B); CE-EMC (EN 55032: 2015, EN 61000-3-2: 2019, EN 61000-3-3: 2013, EN 50130-4: 2011 +A1: 2014); RCM (AS/NZS CISPR 32: 2015); IC VoC (ICES-003: Issue 6, 2019); KC (KN 32: 2015, KN 35: 2015)
Safety	UL (UL 60950-1); CB (IEC 60950-1:2005 + Am 1:2009 + Am 2:2013, IEC 62368-1:2014); CE-LVD (EN 60950-1:2006+A2:2013, IEC 62368-1:2014+A11:2017); BIS (IS 13252(Part1):2010+A1:2013+A2:2015); LOA (SANS IEC60950-1)
Environment	CE-RoHS (2011/65/EU); WEEE (2012/19/EU); Reach (Regulation (EC) No 1907/2006)
Protection	IP67 (IEC 60529-2013), IK10 (IEC 62262:2002)

Dimensions



Accessories

NOT INCLUDED				
				
SRSM Rain Shade	CPM Pendant Mount	WMS Wall Mount	WMSB Wall Mount (Black)	CB120 Junction Box
				
PM Vertical Pole Mount	CM Corner Mount	PC120 Pendant Cap	PC120B Pendant Cap (Black)	