



Performance Series Thermal Cameras

# Thermal Technology Made Affordable

**HIKVISION**

# Overview of Performance Series Thermal Cameras



Specifically designed for short-range detection, Hikvision Performance Series Thermal Cameras are best suited and priced for residential, commercial and industrial areas. These cameras also work well combined with long-range thermal cameras where short-range areas are sometimes overlooked or under-equipped. This groundbreaking camera series packs thermal and optical cameras together with thermal imaging-based fire detection, temperature monitoring, cigarette smoking detection, DeepinView intrusion detection and abnormal sound detection. Manufactured by Hikvision's semiconductor fabrication plant, HikMicro, the 160x120 vanadium oxide (VOx) thermal imaging module's resolution is upscaled to 320x240 with Hikvision's outstanding thermal image quality, all with a dramatically reduced cost.

Changing lighting conditions and shadows act as "noise" to video content analysis (VCA) functions of smart security cameras that see visible light. Hikvision thermal cameras, on the other hand, use a germanium lens that is transparent to thermal infrared radiation and effectively blocks visible and ultraviolet light. The thermal imaging module quickly and accurately senses thermal radiation and uses it to render detailed images. Thermal imaging is stable because the temperature of matter is much more stable than typical lighting conditions. Thermal video is effective in daylight, complete darkness, rain, fog, smoke, against dazzling light and moving shadows. Security guards can easily spot objects that are warmer or cooler in contrast to surroundings such as people, animals, vehicles, fires, and overheating or failed equipment.

Thermal cameras are ideally suited to improve VCA performance due to greater 24/7 image stability. In this camera series, the thermal sensor is paired with a high speed graphics processing unit (GPU) to realize new and improved VCA algorithms developed with Hikvision deep learning technology, DeepinView. DeepinView distinguishes humans and vehicles from other objects moving in or out of user defined areas. The coupling of thermal and DeepinView significantly reduces false alarms and missed alarms. Increased alarm accuracy is crucial for short range perimeter defense.



Bi-spectrum models combine the best thermal imaging-based detection and color video-based identification capabilities. Bi-spectrum camera models see two electromagnetic spectra: the thermal spectrum (long-wavelength infrared), and the optical spectrum (visible light). When the optical module enters night mode, it also sees near-infrared light, which is a subdivision of the infrared spectrum. Bi-spectrum models include a 2 MP/1080p optical imager that provides outstanding full HD color video in very dim environments down to 0.002 lux. The built-in IR illumination enables black and white night vision surveillance using the optical camera in zero-light up to 50 feet with the turret camera and up to 130 feet with the bullet camera. The bi-spectrum camera system provides a video channel for each of the two spectra and can be configured for picture-in-picture viewing (with the thermal view inside the optical view), or for thermal-optical fusion enhanced viewing at 1080p resolution on the thermal channel.

The Performance Series Thermal cameras are elegantly packaged in a single turret or bullet style housing weighing approximately 2 to 3 pounds, which reduces installation time and costs. Only a single Ethernet cable with standard PoE or DC 12 V power and one IP address are required. The built-in micro SD slot supports up to 256 GB of local storage, and the built-in web server allows the camera system to be viewed and managed directly via web browser, free Hikvision desktop software, and mobile apps.



# Key Benefits of Performance Series Thermal

OPTICAL CAMERA MISSES PERSON



THERMAL CAMERA SEES PERSON



THERMAL CAMERA MONITORS TEMPERATURES

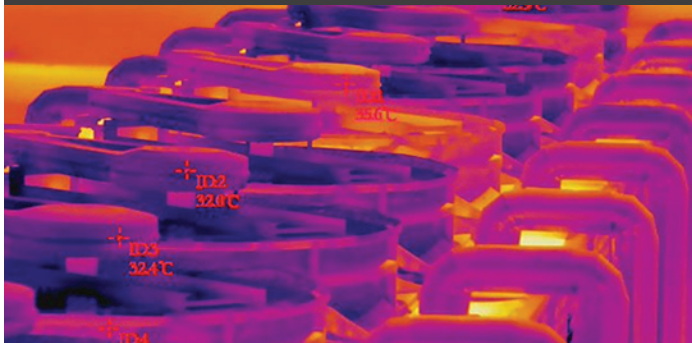

THERMAL CAMERA DETECTS SMOKING

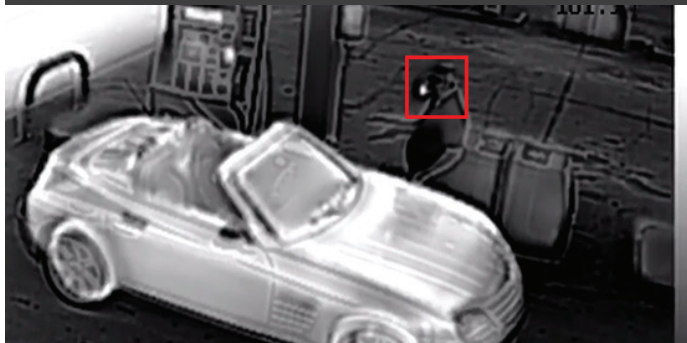

- **Superior Visibility and Image Stability**

Thermal video is not affected by shadows, complete darkness, strong light, or by a significant amount of smoke, fog and rain. The optional optical module provides supplementary full HD color video in low light, and IR illuminated black and white video in darkness. Thermal-optical models combine the best detection and identification technologies in a small and elegant form.

- **Outstanding Intrusion Detection with Reliable Alarms and Video Verification**

Thermal video makes it easy to spot objects with temperature or emissivity in contrast to the surroundings. Hikvision combines the superior visibility and image stability advantages of thermal video with its DeepinView technology. This delivers the most effective automatic detection of humans and/or vehicles moving in or out of user-defined areas, while reducing nuisance alarms from other detections. The optical camera in bi-spectrum models can provide important forensic data, helping to identify key information for first responders or for litigation.

- **Prevent Equipment Failure with Temperature Monitoring**

When the surface temperature of an object is abnormal, the camera will immediately trigger an alarm for timely troubleshooting.

- **Prevent Fires with Temperature Monitoring**

Temperature exception alarms can be used to detect potential fires before they start. The alarm and video can alert people and show where the problem is. In some use cases, it may be ideal to make the camera trigger an automated response to prevent fire.

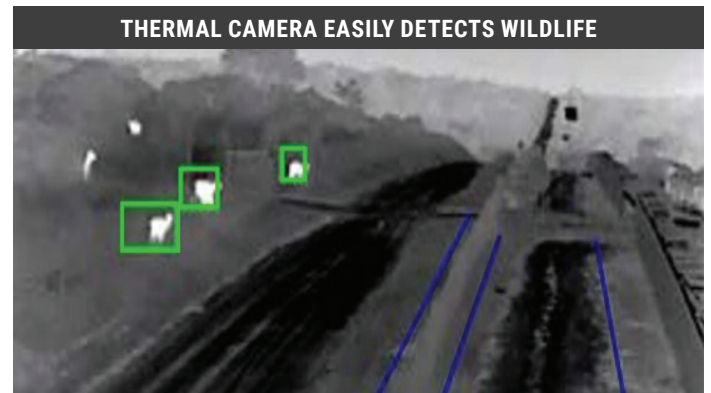
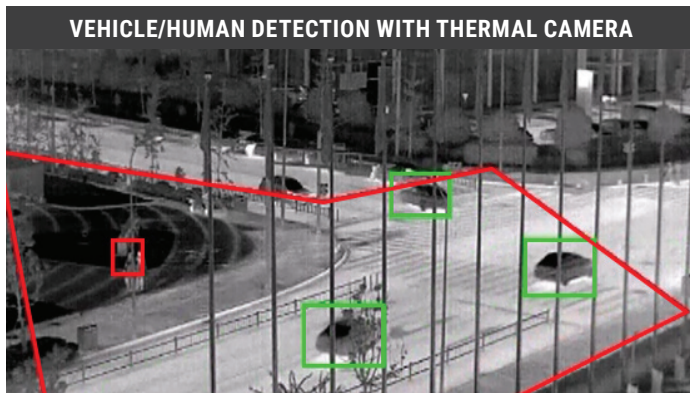

- **Detect and Locate Fires Early with Advanced Fire Detection**

When fire is detected, the camera will immediately trigger an alarm for timely response. Thermal fire detection cameras detect and locate fires sooner, at greater distances, and over larger areas than other detectors. Fire is detected based on an algorithm including the detected temperature and shape of the flames, and up to ten fires can be detected at once.

- **Enable Efficient Allocation of Staff and Improve Enterprise Valuation**

Thermal camera systems combined with video content analysis have represented the leading edge of available technology in some of the most demanding applications, including critical perimeters, unattended remote monitoring applications, fire prevention, predictive maintenance and process control. False alarms in these applications reduce profitability, fatigue staff, and can ultimately reduce response times. Even worse, lack of early warning temperature-related alarms leads to exacerbated losses and repair costs. Using Hikvision's thermal-optical bi-spectrum technology with DeepinView video content analysis can help managers improve staff allocation, reduce losses and increase profitability.

- **Great Return on Investment Potential**

More advanced and affordable than ever before, Hikvision Performance Series bi-spectrum models with thermal and optical sensors are small, lightweight, and easy to install with one Ethernet cable for data and power. With pricing and installation on par with many standard optical cameras. Savings from disaster avoidance and reduced false alarms can easily exceed the total cost of ownership resulting in a net gain.

# Advanced Features

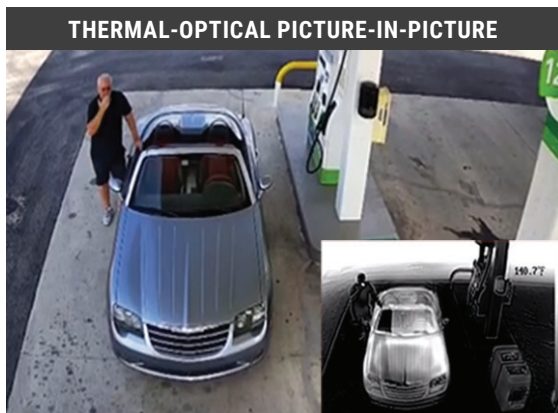

## Bi-Spectrum Picture-in-Picture:

Get the most information from thermal and optical spectra in a single channel using the picture-in-picture feature. The thermal video displays within the optical video, and its position is adjustable.

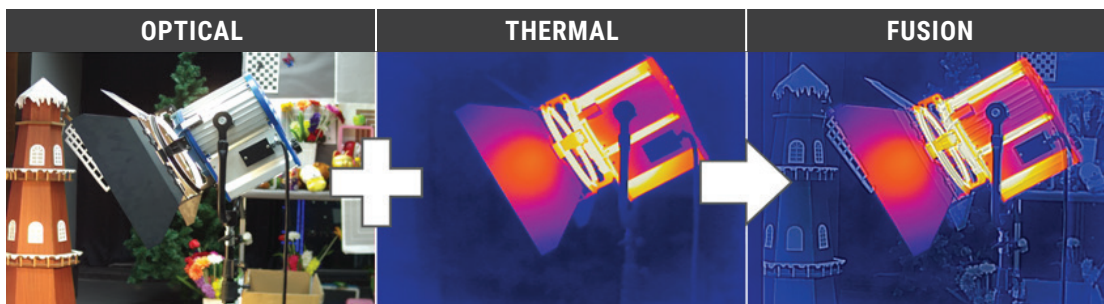

## Bi-Spectrum Image Fusion:

Fusion of thermal and optical video adds more visual context to thermal imagery. The optical channel remains unchanged while the thermal channel becomes a fusion of thermal imagery with optical-based object outlines at HD resolution.

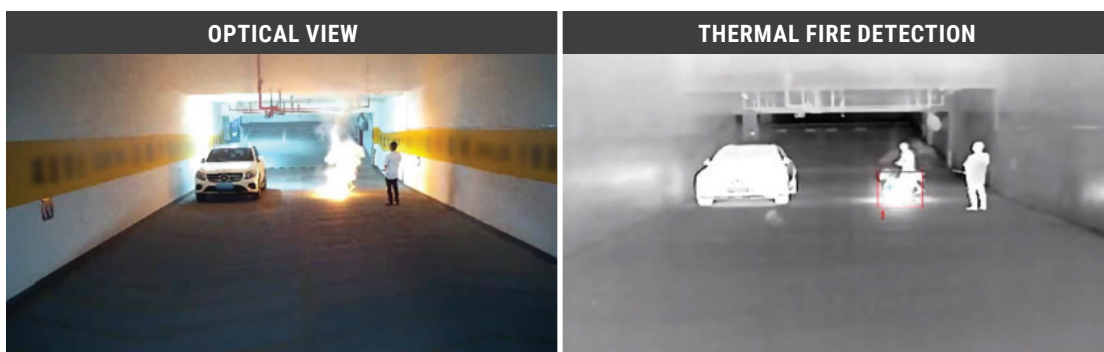

## Advanced Fire Detection:

Up to 10 fires can be detected simultaneously anywhere in the thermal field of view. Thermal fire detection cameras detect fires sooner, at greater distances and over larger areas than other detectors. And, they show where the fires are even when they are difficult to see. The camera's alarm output can trigger fire suppression and alarms earlier than smoke and heat detectors.



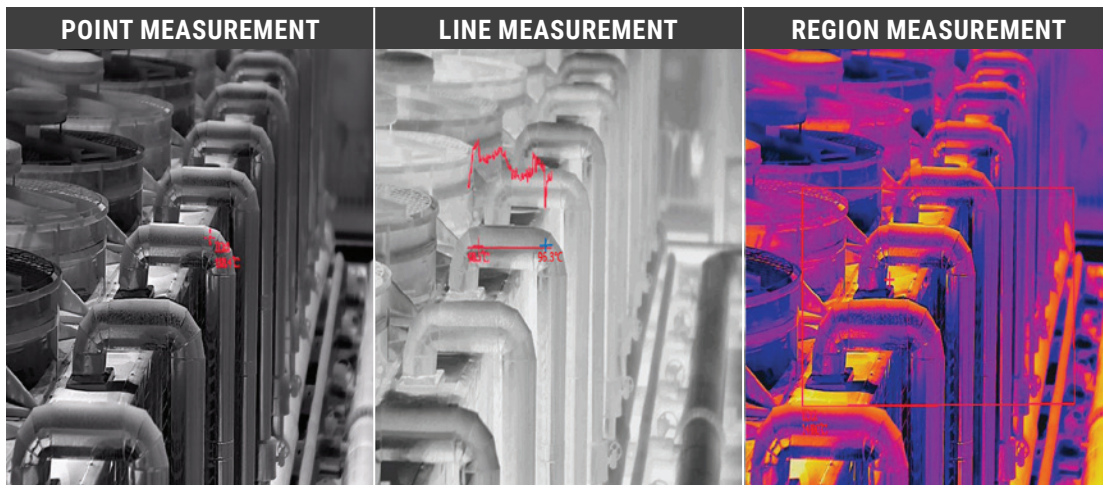

**Temperature Measurement:**

Temperatures in the range of -4 degrees Fahrenheit to 302 degrees Fahrenheit can be monitored at 10 points, throughout 10 regions and across one line all at the same time. A key benefit of using a thermal camera for temperature monitoring is that larger areas can be monitored without disturbance and the video shows exactly where the temperature exceptions are located. Temperature monitoring can be used for fire prevention, process automation, predictive maintenance, failsafe triggering, and safety warnings. Thermal alarm benefits also include:

- With a 160x120 thermal detector, the cameras have 19,200 temperature sensors.
- Alarm thresholds can be set for rising or falling temperatures.
- Pre-alarms provide early warning of problems, which enables timely human or automated intervention before disaster occurs.
- Secondary alarms on more extreme temperatures can trigger further escalated responses.

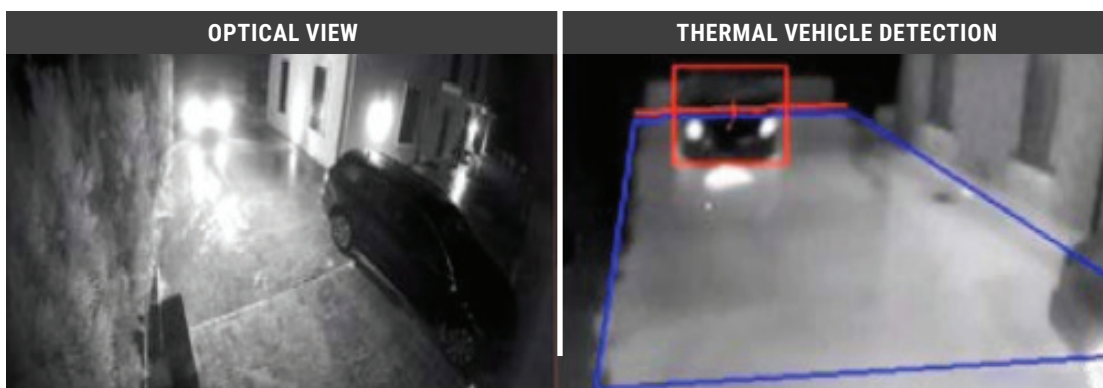

**DeepinView Thermal Perimeter Protection:**

Thermal combined with Hikvision’s DeepinView technology greatly improves the accuracy of intruder and visitor detection. Thermal imaging helps quickly detect warm objects such as humans and vehicles, independent of adverse lighting, weather and some hiding tactics such as fogging, dazzling, wearing camouflage and crawling. With DeepinView, non-human and non-vehicular objects triggering line crossing, intrusion zone, region entrance and region exit detections can be automatically suppressed to prevent nuisance alarms in outdoor and indoor intrusion detection applications.

# Applications



## Commercial Buildings

All types of commercial buildings can benefit from thermal, including office space, retailers, hotels, and special purpose. Bi-spectrum Performance Series Thermal technology can protect perimeters, parking lots, restricted areas, roofs, HVAC, and areas with potential fire risks. With better accuracy than traditional security solutions, staff and monitoring centers will only need to respond to relevant human, vehicle, temperature and fire-triggered alarms. Businesses can benefit from reduced security costs and losses, leading to increased profits.

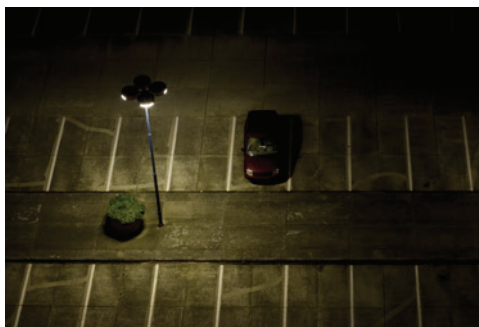

## Parking Lots

Nearly all types of parking lots have a range of challenges including vandalism, theft, illegal parking, and stalking at malls, retail stores, commercial buildings, car dealerships, hotels, airports and more. Parking lots are often very dark at night, which reduces the detection range of optical cameras. Thermal cameras easily detect people and vehicles any time of day or night with greater accuracy. The cameras can alert the security guard or monitoring center to take action immediately, and employees can check the thermal video for people lurking in the parking lot before going outside.



## Residential

Using standard optical cameras with motion, intrusion or line crossing detection, home surveillance systems often suffer from constant false alarms. As a result of repeated false alarms, homeowner often ignore or disable the system. Fortunately, with the affordable Performance Series Thermal cameras, the residential market can now enjoy greatly reduced false alarms and improved detection capabilities even in visually challenging environments. Homes with garages and other fire risk areas, such as surrounding woods, can utilize the cameras' advanced fire detection to send instant notifications of fires to a homeowner's smartphone.



## Retail Stores

During closed hours, light entering through the windows ordinarily causes false alarms with optical cameras, but thermal DeepinView solves this. When thieves use fog, smoke or intense lights to blind optical cameras, thermal cameras can still see what is happening. Big box retailers with merchandise stored outside the entrances also benefit from the accurate detection capabilities of thermal-optical cameras. Thermal cameras also provide invaluable fire detection capabilities indoors and outdoors with instant remote notification.



## Construction Sites and Yards

Construction sites, and yards for salvage, scrap, impoundment and evidence are examples of fenced-in open areas containing building frames, tools, materials and other items that are often targeted by thieves and arsonists. These large areas are often dark at night, but this is not a problem for thermal cameras. Standard optical cameras cannot see very far at night, and they often have false alarms due to passing vehicle headlights. Thermal security cameras accurately and instantly detect perimeter break-ins, enabling security personnel to react swiftly to minimize loss. Bi-spectrum cameras are the best choice as they also provide additional identification and safety information for first responders.





### **Commercial Laundry Facilities**

There are more than 25,000 commercial laundry facilities in the U.S. Fires can be caused by lint in and around dryers, oil-contaminated cloth and auto-ignition of unattended laundry sacks in the middle of the night. Some facilities use handheld thermal cameras, which only help when someone is inspecting one item at a time. Fixed thermal cameras can monitor all hazard areas around the clock, and optimize prevention of damage and downtime.



### **Industrial Facilities**

Factories, warehouses, fulfillment centers, laboratories, data centers, and other industrial facilities need perimeter and restricted area protection, predictive maintenance for machinery, and fire prevention for equipment and materials. Performance Series Thermal cameras excel at these tasks.



### **Infrastructure**

Infrastructure such as power generation and distribution, water, recycling, and composting facilities, oil and gas wells, refineries and antenna sites benefit from short-range perimeter protection and advanced fire detection. Compost piles often ignite internally due to the self-generated heat. Lithium-ion batteries are commonly tossed into recycling bins and cause costly fires at recycling centers. Thermal cameras can detect temperature rises in electrical equipment, compost and recycling piles, helping to prevent fires or detect fires early.



### **Education**

K-12 schools have short-range perimeters that need protection, no-smoking rules that need enforcing, infrastructure that needs predictive maintenance and potential fires to prevent. Performance Series Thermal cameras can detect intruders, lit cigarettes, equipment temperature and fire. These accurate detection capabilities are key components of a complete security solution.



### **Agriculture**

Various agricultural facilities, equipment, livestock, assets and grow areas need perimeter protection from predators, thieves and threat of fire. Performance Series Thermal cameras can easily detect and report these threats.



### **Roads, Tunnels and Bridges**



Performance Series Thermal cameras can use directional line crossing to detect vehicles traveling the wrong way. They can also detect people and wildlife approaching the road in common crossing areas. Instant notifications can alert traffic authorities and oncoming drivers to the danger.



### **Gas Stations**

Gas stations usually have optical cameras watching the customers at the fuel pumps, but those cameras cannot detect dangerous and illegal cigarette smoking or fire. In addition to providing full HD color video, the Performance Series Thermal cameras have the special ability to detect fires and lit cigarettes. The camera can alert the station attendants to the danger for quick resolution.

# Models and Specifications

Available Models			
Model	<b>Thermal Bullet</b> DS-2TD2117-3/V1 DS-2TD2117-6/V1	<b>Thermal-Optical Bullet</b> DS-2TD2617-3/V1 DS-2TD2617-6/V1	<b>Thermal-Optical Turret</b> DS-2TD1217-2/V1 DS-2TD1217-3/V1 DS-2TD1217-6/V1
Brackets	CB130, PM, CM	CB130, PM, CM	[CB135, CM1, PM1], PC140, WMS, PM, CM, CPM

Module	Sensor	Frame Rate	Lens	Min. Illumination	Smart Alarms	Enhancements
<b>Thermal</b>	160×120, 17 μm pitch, VOx UFPA, NETD < 40 mK	25 fps	2/3/6 mm	---	Temperature, Fire, Human, Vehicle, Line Cross, Intrusion, Region Exit/Entrance, Sound	320×240 Upscaling, Adaptive AGC, Digital Detail Enhancement, 3D DNR, 15 Palettes
<b>Optical</b>	1920×1080, 1/2.7" CMOS	30 fps	2/4/6 mm	0.002 lux (color) 0.001 lux (B/W) 0 lux with IR on	Motion	Thermal-Optical Image Fusion, Picture-In-Picture, AGC, True WDR, 3D DNR

Thermal Lens	Thermal Field of View	Optical Lens	Optical Field of View	VCA Human Detection Range (5' 11" human)	VCA Vehicle Detection Range	Fire Detection Range (1 m <sup>2</sup> fire)	Temperature Measurement Range
<b>2 mm</b>	90.0° × 66.4°	2 mm	101° × 77.0°	46 ft (14 m)	138 ft (42 m)	177 ft (54 m)	72 ft (22 m)
<b>3 mm</b>	50.0° × 32.7°	4 mm	87.0° × 46.2°	69 ft (21 m)	207 ft (63 m)	295 ft (90 m)	108 ft (33 m)
<b>6 mm</b>	25.0° × 18.7°	6 mm	53.0° × 30.0°	138 ft (42 m)	413 ft (126 m)	591 ft (180 m)	216 ft (66 m)

## Product Dimensions

### Thermal-Optical Turret

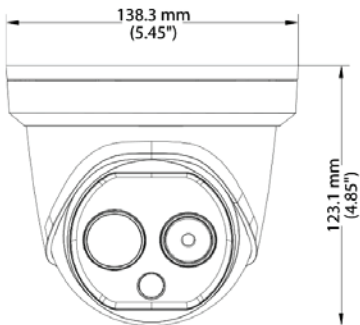

### Thermal-Optical Bullet

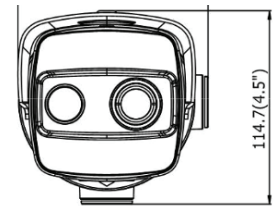
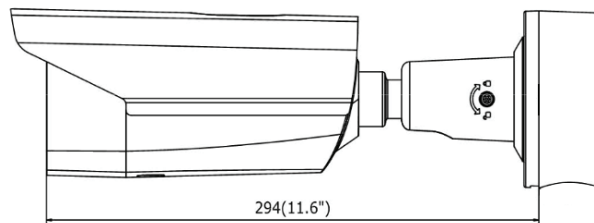

### Thermal Bullet

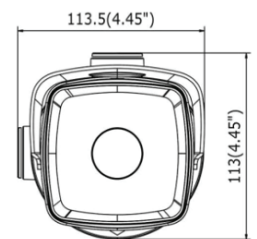
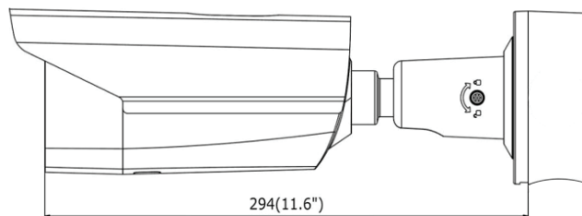

# Bracket Diagrams

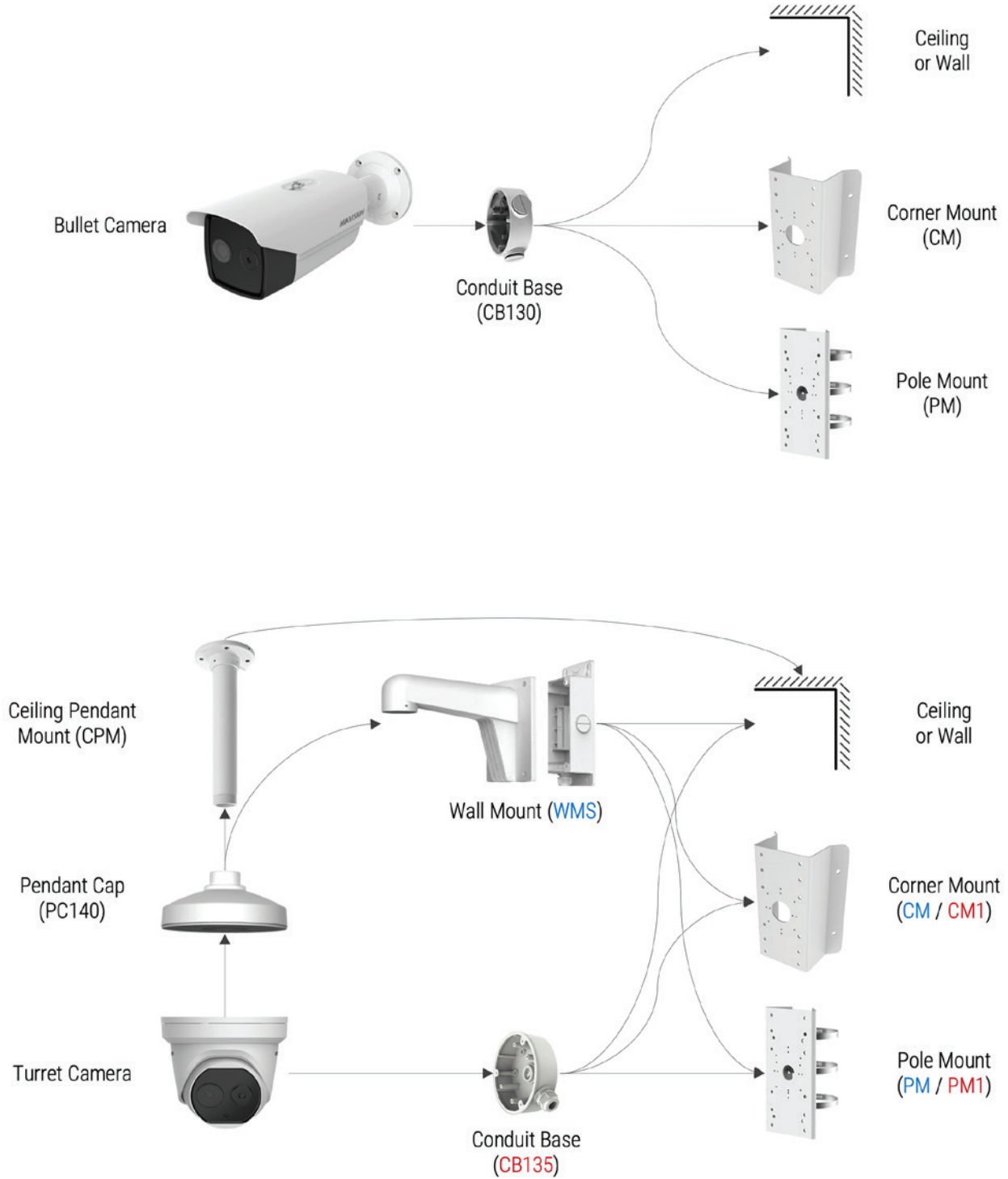



**Hikvision USA Inc.**  
18639 Railroad Street  
City of Industry, CA 91748

**Hikvision Canada Inc.**  
4848 Levy Street  
Saint-Laurent, Quebec H4R 2P1

**Contact Information**  
Toll-Free: +1 866-200-6690 (U.S. and Canada)  
Phone: +1 909-895-0400  
Email: [verticals.usa@hikvision.com](mailto:verticals.usa@hikvision.com)  
**[hikvision.com](http://hikvision.com)**

Connect with us: [!\[\]\(666e09182d4cd268646ea700ea60dcdf\_img.jpg\)](#) [!\[\]\(1ef1ef0bf9af6c6996401964cf280f2d\_img.jpg\)](#) [!\[\]\(e9a80c8557f9285916925bd4ac40fff5\_img.jpg\)](#) [!\[\]\(88e2edecff3400e68a80dd08c57d2f9c\_img.jpg\)](#) [!\[\]\(b612b1233231807474dc279cea9675f1\_img.jpg\)](#)

©2020 Hikvision USA Inc. and Hikvision Canada Inc. All rights reserved. Hikvision is a registered trademark of Hikvision Digital Technology Co., Ltd. in the US, Canada and other countries. All other trademarks, service marks, and product or service names are trademarks or registered trademarks of their respective owners. Product specifications and availability are subject to change without Notice.