

DS-2DF6A436X-AEL**4 MP Outdoor 36x Network PTZ Dome****DarkFighter™**

- **1/1.8" Progressive Scan CMOS**
- **Up to 2560 x 1440 Resolution**
- **Minimum Illumination:**
Color: 0.002 Lux @ (F1.5, AGC On)
B/W: 0.0002 Lux @ (F1.5, AGC On)
- **H.265+/H.265 Video Compression**
- **36x Optical Zoom, 16x Digital Zoom**
- **Smart Tracking**
- **Smart Detection: Line Crossing, Intrusion, Region Enter/Exit**
- **Rapid Focus**
- **120 dB WDR, 3D DNR, HLC**
- **IP67, IK10 Protection**
- **24 VAC/Hi-PoE (60 W), PoE Injector Included**

Hikvision DS-2DF6A436X-AEL Network PTZ Dome Cameras produce images with a resolution of up to 2560 x 1440 pixels.

The embedded 1/1.8" progressive scan CMOS chip supports True WDR, and the 36x optical zoom allows for greater detail to be collected over more expansive areas.

The Network PTZ Dome Camera also features a wide range of smart functions, including intrusion detection, line crossing detection, and audio exception, which allows for key events and objects to be recorded for further forensic needs.

The camera also supports Rapid Focus, which allows for the camera to maintain focus while the lens is zoomed, eliminating auto-focus hunting, and producing clear images at all times.

Smart tracking is included in this model, and enables the camera to detect moving objects by following them within the camera's area of coverage.

Available models:
DS-2DF6A436X-AEL



Specifications

DS-2DF6A436X-AEL

Camera Module

Image Sensor	1/1.8" progressive scan CMOS
Minimum Illumination	Color: 0.002 Lux @ F1.5, AGC on; B/W: 0.0002 Lux @ (F1.5, AGC on); 0 Lux with IR
Shutter Time	1/1 to 1/30,000 s
White Balance	Auto / manual / ATW [auto-tracking white balance] / indoor / outdoor / fluorescent lamp / sodium lamp
AGC	Auto / manual
Day and Night	IR cut filter
Digital Zoom	16x
Privacy Mask	24 programmable privacy masks
Focus Mode	Auto / semi-automatic / manual
WDR	120 dB
Rapid Focus	Supported

Lens

Focal Length	5.7 mm to 205.2 mm, 36x optical zoom
Zoom Speed	Approximately 4.4 s (optical lens, wide to tele)
FOV	Horizontal field of view: 59.8° to 2.0° (wide-tele); Vertical field of view: 33.6° to 1.1° (wide-tele); Diagonal field of view: 68.6° to 2.3° (wide-tele)
Minimum Working Distance	10 mm to 1,500 mm (wide to tele)
Aperture Range	F1.5 to F4.5

PTZ

Movement Range [Pan]	360° endless
Pan Speed	Configurable, from 0.1°/s to 300°/s, Preset Speed: 540°/s
Movement Range [Tilt]	From -20° to 90° (auto-flip)
Tilt Speed	Configurable, from 0.1°/s to 240°/s, Preset Speed: 400°/s
Proportional Zoom	Supported
Presets	300
Patrol Scan	8 patrols, up to 32 presets for each patrol
Pattern Scan	4 pattern scans, record time over 10 minutes for each scan
Power-off Memory:	Supported
Park Action	Preset / pattern scan / patrol scan / auto scan / tilt scan / random scan / frame scan / panorama scan
3D Positioning	Supported
PTZ Status Display	Supported
Preset Freezing	Supported
Scheduled Task	Preset / pattern scan / patrol scan / auto scan / tilt scan / random scan / frame scan / panorama scan / dome reboot / dome adjust / aux output

Compression Standard

Video Compression	Main stream: H.265+ / H.265 / H.264+ / H.264; sub-stream: H.265 / H.264 / MJPEG; third stream: H.265 / H.264 / MJPEG
H.264 Type	Baseline profile / main profile / high profile
H.264+	Supported
H.265 Type	Main profile
H.265+	Supported
Video Bitrate	32 kbps to 16,384 kbps
Audio Compression	G.711alaw / G.711ulaw / G.722.1 / G.726 / MP2L2 / PCM
Audio Bitrate	64 kbps [G.711] / 16 kbps [G.722.1] / 16 kbps [G.726] / 32 to 160 kbps [MP2L2]

Smart Features

Face Capture	Detect and capture faces and upload face pictures
Perimeter Protection	Intrusion detection, line crossing detection, region entrance detection, region exiting detection, alarm triggering by specific target types (humans and vehicles). Filtering out of false alarms caused by leaves, light, animals, flags, and other such target types.
Event Detection	Audio exception detection
Smart Tracking	Manual tracking, auto tracking (supports the tracking of specified target types, such as humans and vehicles), event tracking
Smart Recording	ANR (Automatic Network Replenishment), Dual-VCA
ROI	Supported

Image

Maximum Resolution	2560 x 1440
Main Stream	30 fps [2560 x 1440, 2048 x 1536, 1920 x 1080, 1280 x 960, 1280 x 720]
Sub-Stream	30 fps [704 x 480, 640 x 480, 352 x 240]
Third Stream	30 fps [1920 x 1080, 1280 x 960, 1280 x 720, 704 x 480, 640 x 480, 352 x 240]
Image Enhancement	HLC / BLC / 3D DNR / Defog / EIS / Regional Exposure / Regional Focus
SVC	Supported

Network

Network Storage	Built-in memory card slot, support microSD / SDHC / SDXC, up to 256 GB; NAS (NPS, SMB / CIFS), ANR
Alarm Linkage	Alarm actions, such as preset, patrol scan, pattern scan, memory card video record, trigger recording, notify surveillance center, upload to FTP / memory card / NAS, send email, etc.
Protocols	IPv4 / IPv6, HTTP, HTTPS, 802.1x, Qos, FTP, SMTP, UPnP, SNMP, DNS, DDNS, NTP, RTSP, RTCP, RTP, TCP / IP, DHCP, PPPoE, Bonjour
API	Open-ended, support ONVIF, ISAPI, and CGI, support for HIKVISION SDK and third-party management platforms
Simultaneous Live View	Up to 20 channels
User / Host	Up to 32 users. Three levels: administrator, operator, and user
Security Measures	User authentication (ID and PW), Host authentication (MAC address); HTTPS encryption; IEEE 802.1x port-based network access control; IP address filtering
Client	iVMS-4200, iVMS-4500, iVMS-5200, Hik-Connect
Web Browser	IE 8 to 11, Chrome 31.0 to 44, Firefox 30.0 to 51









Interface

Alarm	7-ch alarm input / 2-ch alarm output
Audio	1-ch audio input / 1-ch audio output
Network Interface	1 RJ45 10 M / 100 M Ethernet Interface, Hi-PoE
RS-485	Half duplex, HIKVISION, Pelco-P, Pelco-D, self-adaptive
BNC	1.0 V [p-p]/75 Ω, NTSC (or PAL) composite, BNC

General

Power	24 VAC (maximum 60 W); Hi-PoE (maximum 50 W), PoE injector included
Working Temperature	-40° F to 158° F (-40° C to 70° C); humidity: ≤ 90%
Protection Level	IP67 standard, IK10, TVS 6,000V lightning protection, surge protection and voltage transient protection
Material	Aluminum alloy
Dimensions	Φ 9.10" x 14"(Φ 231.1 mm x 355.6 mm)
Weight	Approximately 13.23 lb (6 kg)

Accessories

								
JBPW-L-G Wall mount	CPM-L-G Long pendant mount	CPMPE-G Pendant mount extension	CPM-S-G Short pendant mount	RPM-G Parapet mount extendable pole	PMP-JB-G Vertical pole mount	CMP-JB-G Corner mount	DS-1100KI Network keyboard	DS-1005KI USB joystick

Dimensions

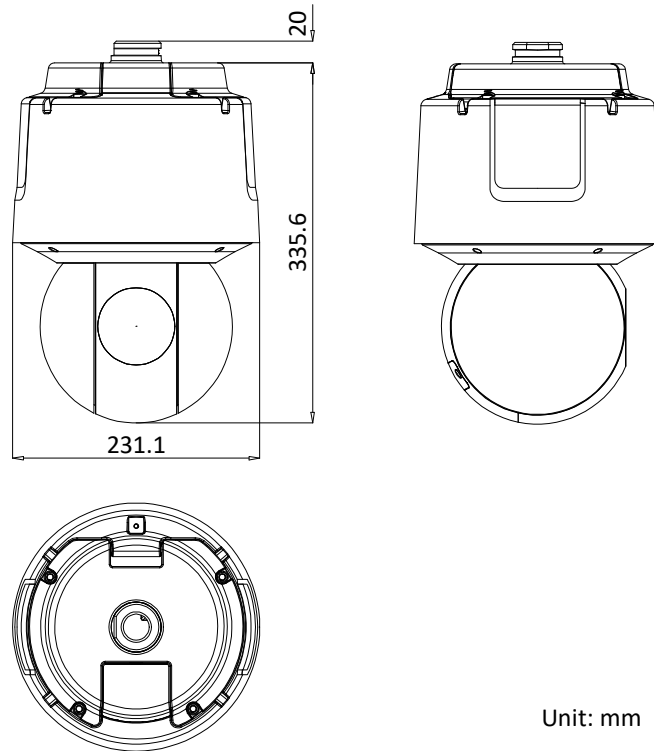

Unit: mm